

# Vein & Pattern *Guide*



# Introduction

We have created this guide to assist you in creating optimal pattern continuity in the design and fabrication of countertops, backsplashes and drop-down countertop ends. Here you will see full slab layout images of each Porcelain model with our suggested pattern continuity visual.

We offer Caesarstone Porcelain slabs in a very large size measuring 3200 mm x 1600 mm (126" x 63"). This means that in the vast majority of designed applications no horizontal surface-to-surface butt joints are required.

However, as Caesarstone Porcelain slabs feature identical designs on each model, in installations where pattern continuity is required, we invite you to use these design layout images as a guide to optimal pattern continuity.

Please note that instructions in the [Caesarstone Porcelain Fabrication & Installation Guide](#) should be followed at all stages.

The information and recommendations set forth herein based on our professional knowledge and experience and the most common cases recorded while working with Porcelain slabs, and are intended for inspiration and use by persons with expertise, professional experience and technical skills, at their own discretion, and subject to their personal and exclusive responsibility. No guarantee or warranty of any kind, express or implied, is made of merchantability, fitness for a particular purpose, or otherwise.



# Design considerations

Every designed application with Caesarstone Porcelain has a unique combination of layout, kitchen size and esthetic considerations. Note that the pattern continuity visuals suggested in this guide are conceptual and not according to dimension.

We recommend that planning pattern continuity for each project be based on but not limited to the following:

- Overall project size
- Consider countertop, backsplash and drop-down end requirements
- Maximize slab utilization and minimising offcuts
- The relative strength or subtlety of a vein or pattern structure in the selected Caesarstone Porcelain model
- Consider how to best utilize the slab size during design, taking into account any desired pattern direction alignment
- Prior to cutting any slabs ensure that all components reflect the design layout
- Consider the color and tonality of the slab design to ensure the best final appearance when joins are required



# Planning Joints in Countertops

As a general rule, when there is a change of direction in the slab make only straight joints, not diagonal or rounded joints. Use diagonal joints only when necessary for continuation of veins or a pattern in the slab.

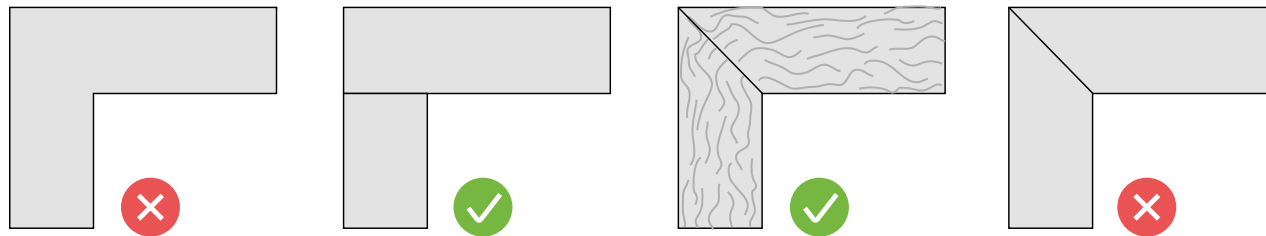

A rounded corner may be fabricated in a single thickness slab where there is a corner/niche no greater than 70 mm (2¾"), **and it is not connected to another slab.**

A 90° corner may be created if the slab has a miter edge profile.

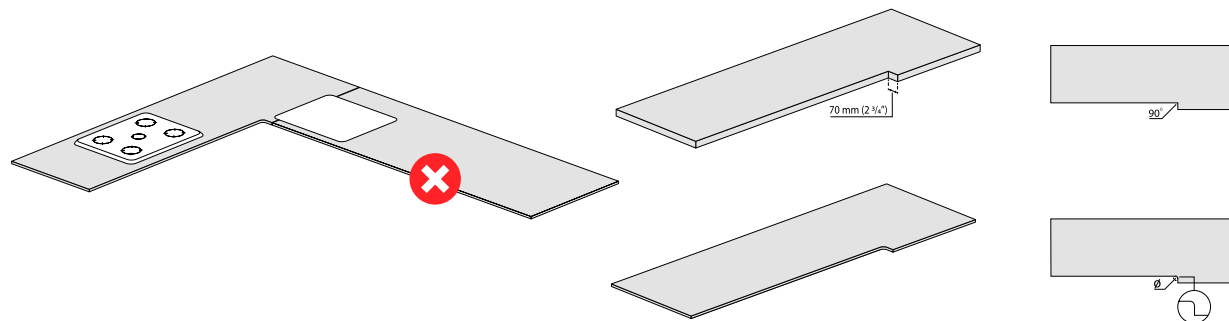

In diagonal corner countertops a joint must be created in one of the corners. If the countertop is single thickness, create a radius of at least 35 mm (1⅜") in the other corner.

For indents from the edge of a slab, for example around a pillar: for slab lengths up to 1600 mm (63"), drill holes in the 2 corners; for slab lengths over 1600 mm (63"), drill a hole in one corner and create a straight joint from the other.

- When installing the countertop, fill the seams between the slabs with adhesive specifically for Porcelain that matches the countertop in color, with properties suitable for the installation environment (indoors and outdoors).
- If the slabs are inconsistent in appearance, check the pieces to be joined in advance to achieve the best possible match.
- Clean each slab piece with clean water at the end of each fabrication stage before it dries.

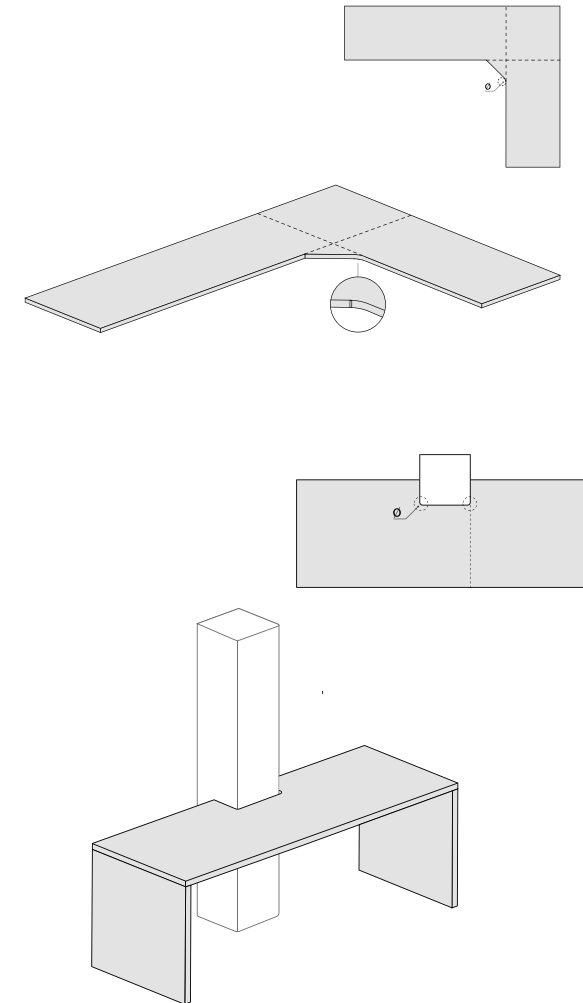

Source: [Caesarstone Porcelain Fabrication and Installation Guide](#)

# Contents

<a href="#">220 Magnate</a> .....	6	<a href="#">511 Smokestone</a> .....	160
<a href="#">410 Aluminous</a> .....	17	<a href="#">512 Transcenda</a> .....	171
<a href="#">411 Concrita</a> .....	28	<a href="#">513 Striata</a> .....	182
<a href="#">412 Beige Ciment</a> .....	39	<a href="#">514 Emprada</a> .....	193
<a href="#">413 White Ciment</a> .....	50	<a href="#">516 Locura</a> .....	204
<a href="#">501 Snowdrift</a> .....	61	<a href="#">531 Libretta</a> .....	215
<a href="#">502 Sleet</a> .....	72	<a href="#">533 Silverdrop</a> .....	226
<a href="#">503 Circa</a> .....	83	<a href="#">540 Monumental</a> .....	237
<a href="#">504 Lumena</a> .....	94	<a href="#">542 Mosstone</a> .....	248
<a href="#">505 Archetta</a> .....	105	<a href="#">543 Marenstone</a> .....	259
<a href="#">506 Mirabel</a> .....	116	<a href="#">544 Auralux</a> .....	270
<a href="#">507 Marbannova</a> .....	127	<a href="#">550 Silvax</a> .....	281
<a href="#">508 Isobellia</a> .....	138	<a href="#">580 Fume</a> .....	292
<a href="#">510 Impermia</a> .....	149	<a href="#">581 Lucillia</a> .....	303



# 220 Magnate | Releasing slab tension

Full Slab

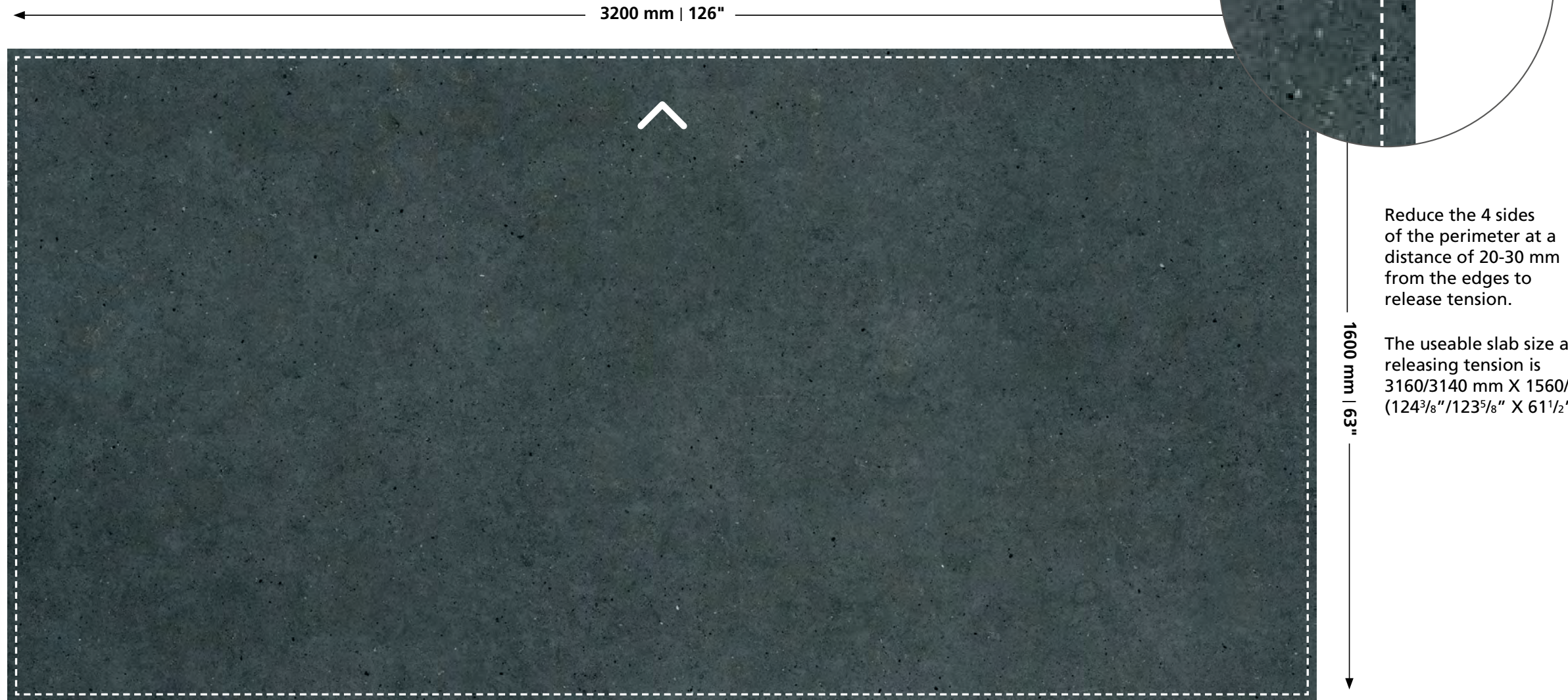

220 Magnate | Pattern continuity plan

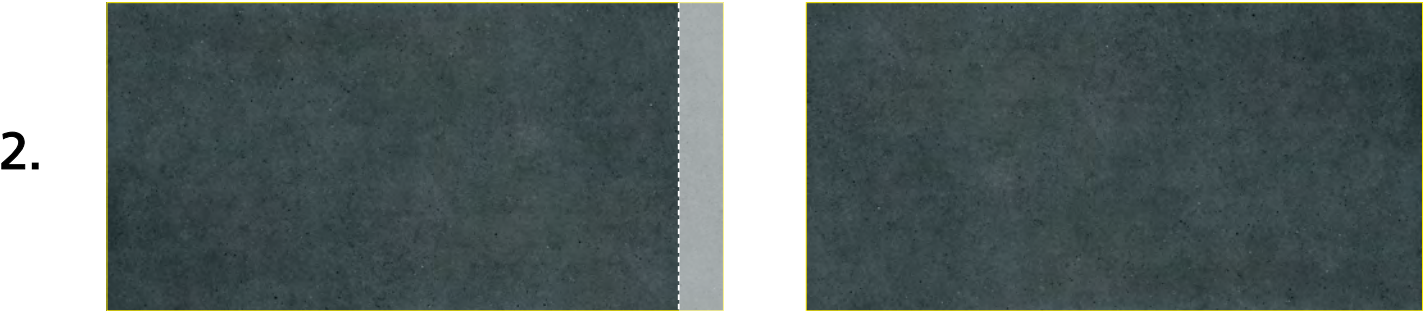

Plan to join the two slabs for pattern continuity and remove the surplus



End result

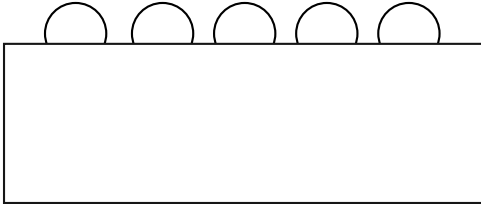

## 220 Magnate | End result

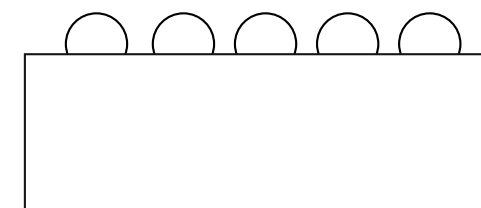
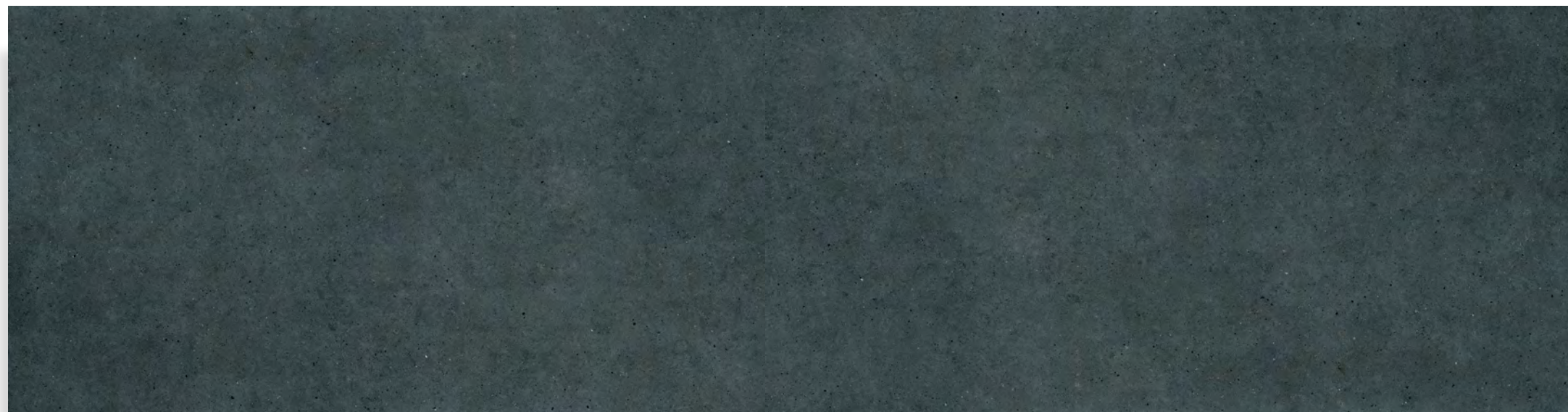

# 220 Magnate | Pattern continuity plan

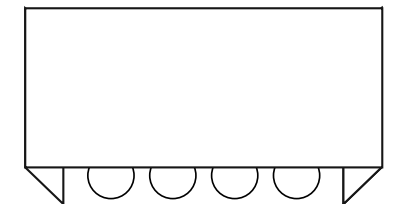
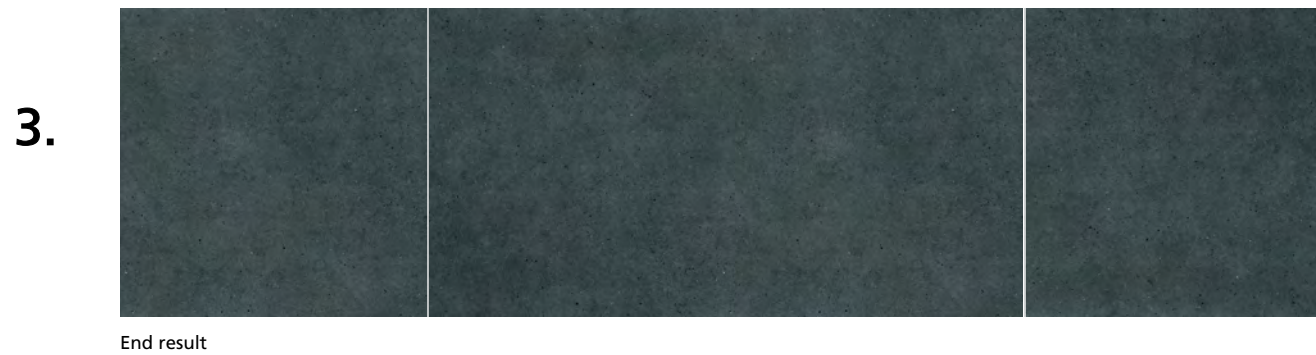
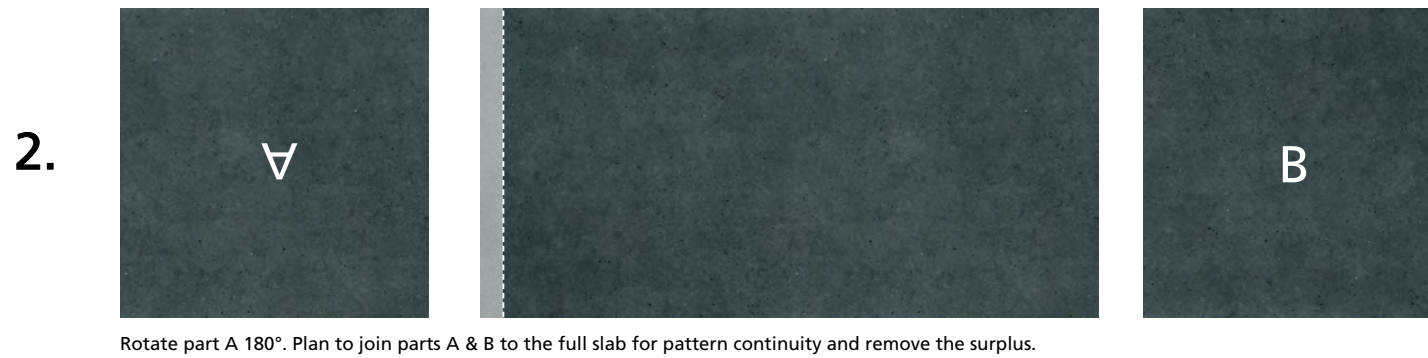
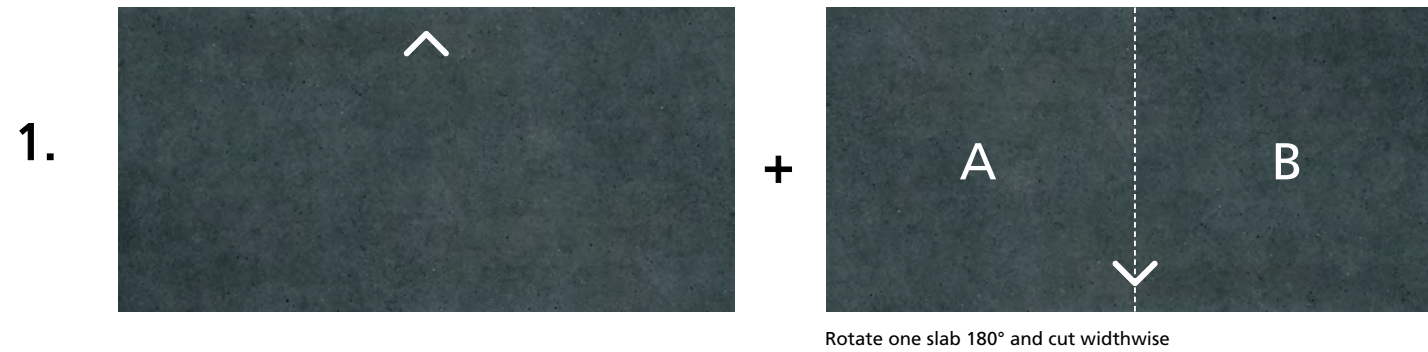

## 220 Magnate | End result

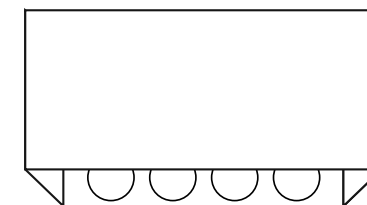
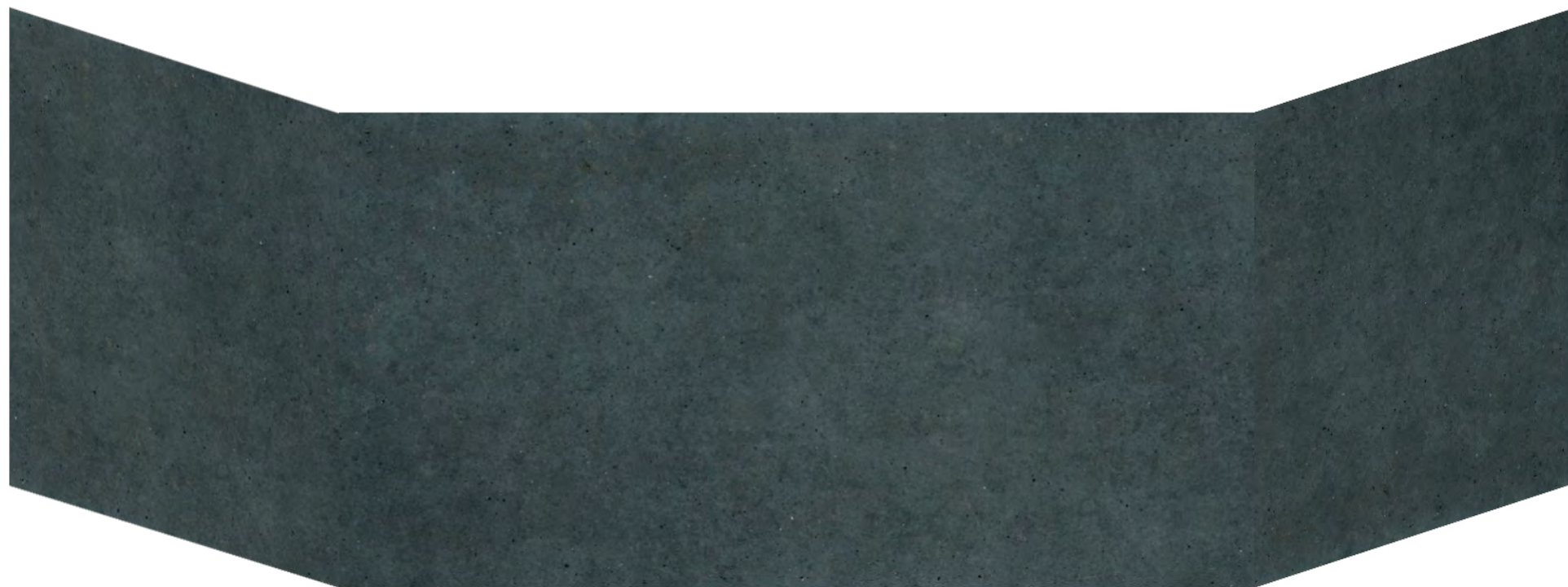

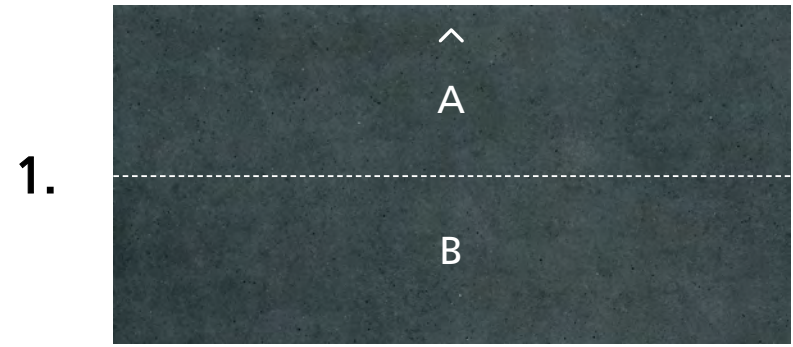

Cut the slab lengthwise

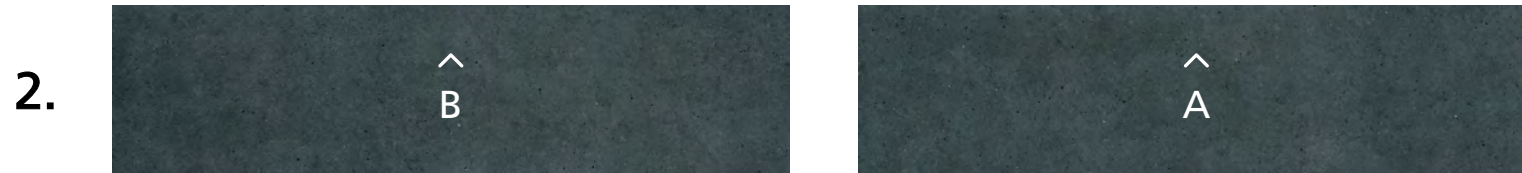

Join parts A & B

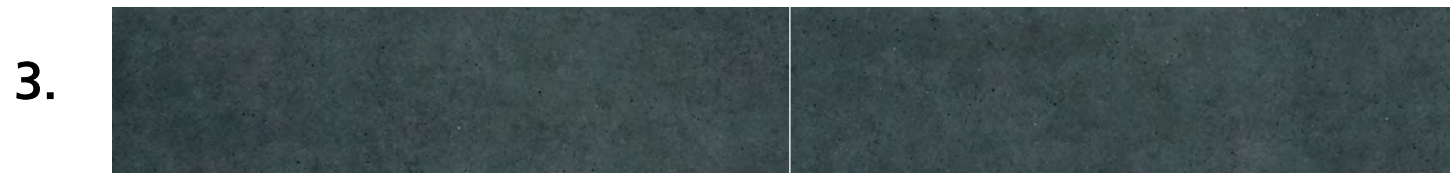

End result

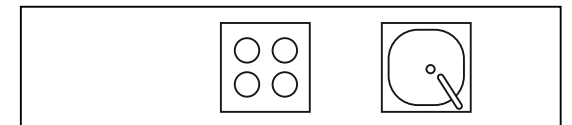

## 220 Magnate | End result

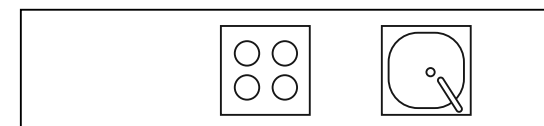
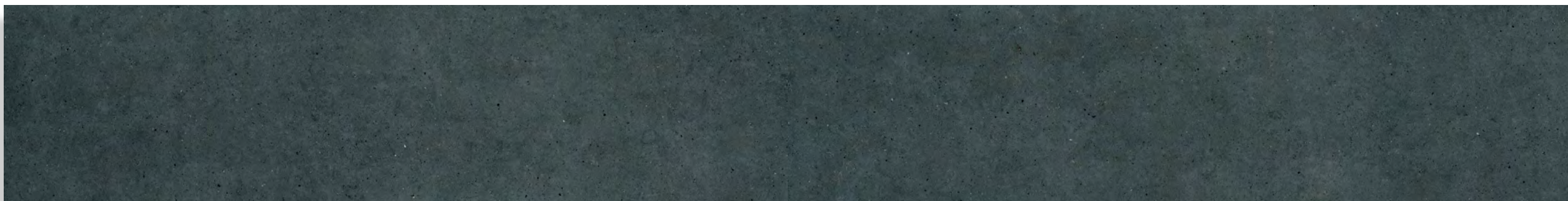

220 Magnate | Pattern continuity L-shape

1.

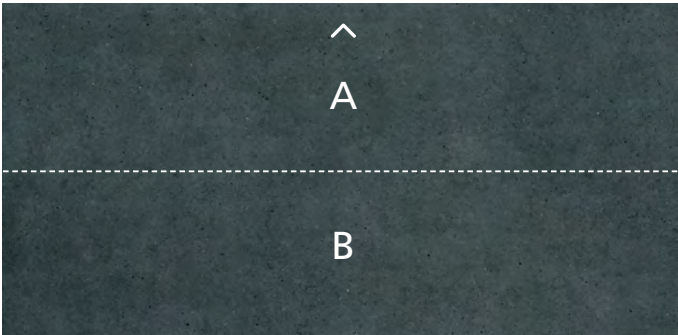

Cut the slab lengthwise

2.

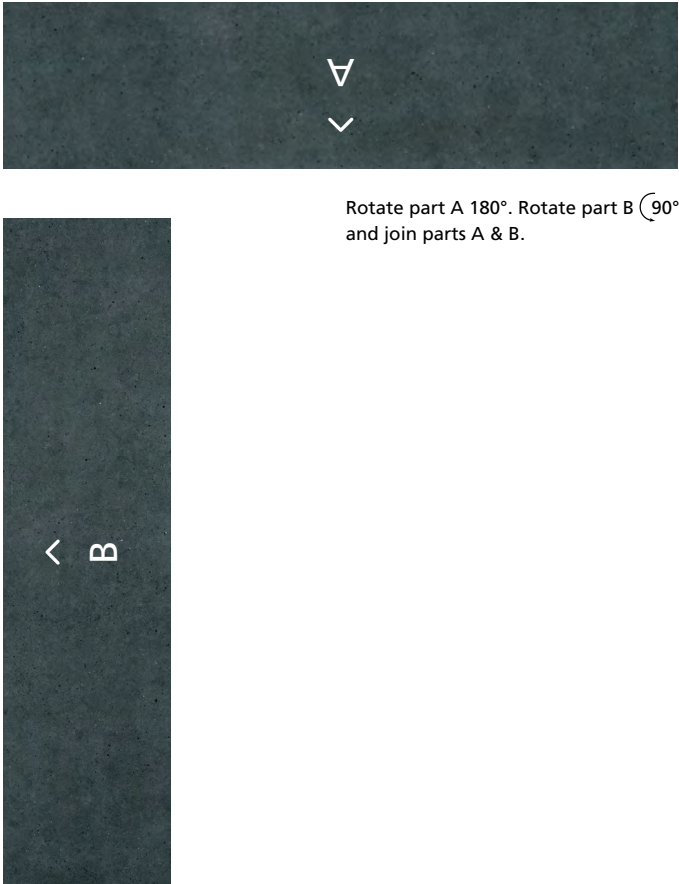

Rotate part A 180°. Rotate part B 90° and join parts A & B.

3.

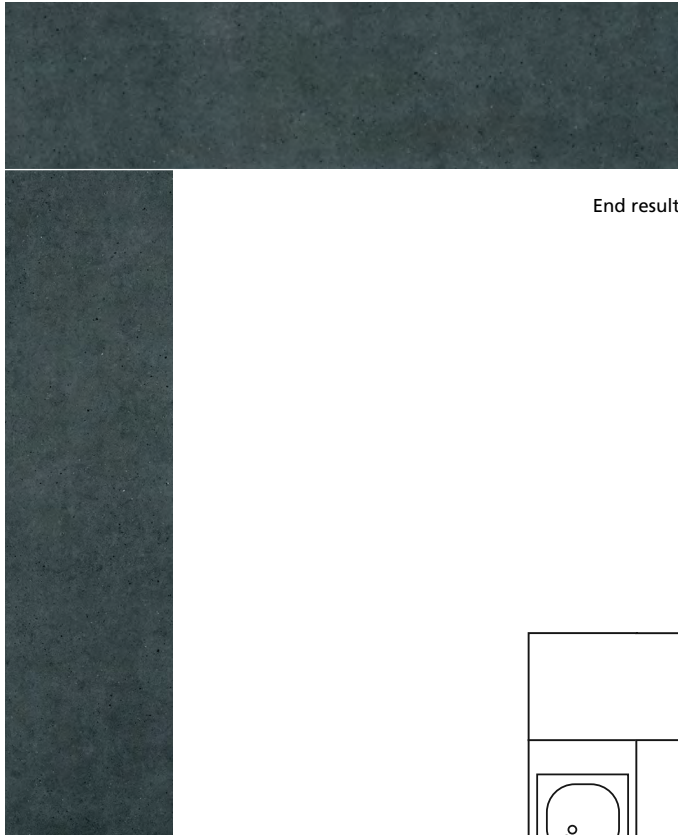

End result

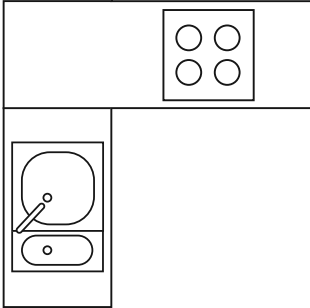

# 220 Magnate | End result

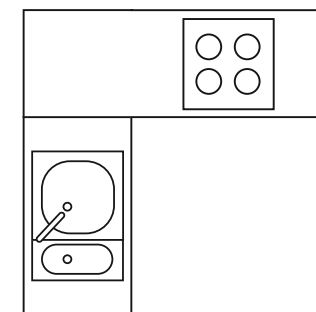
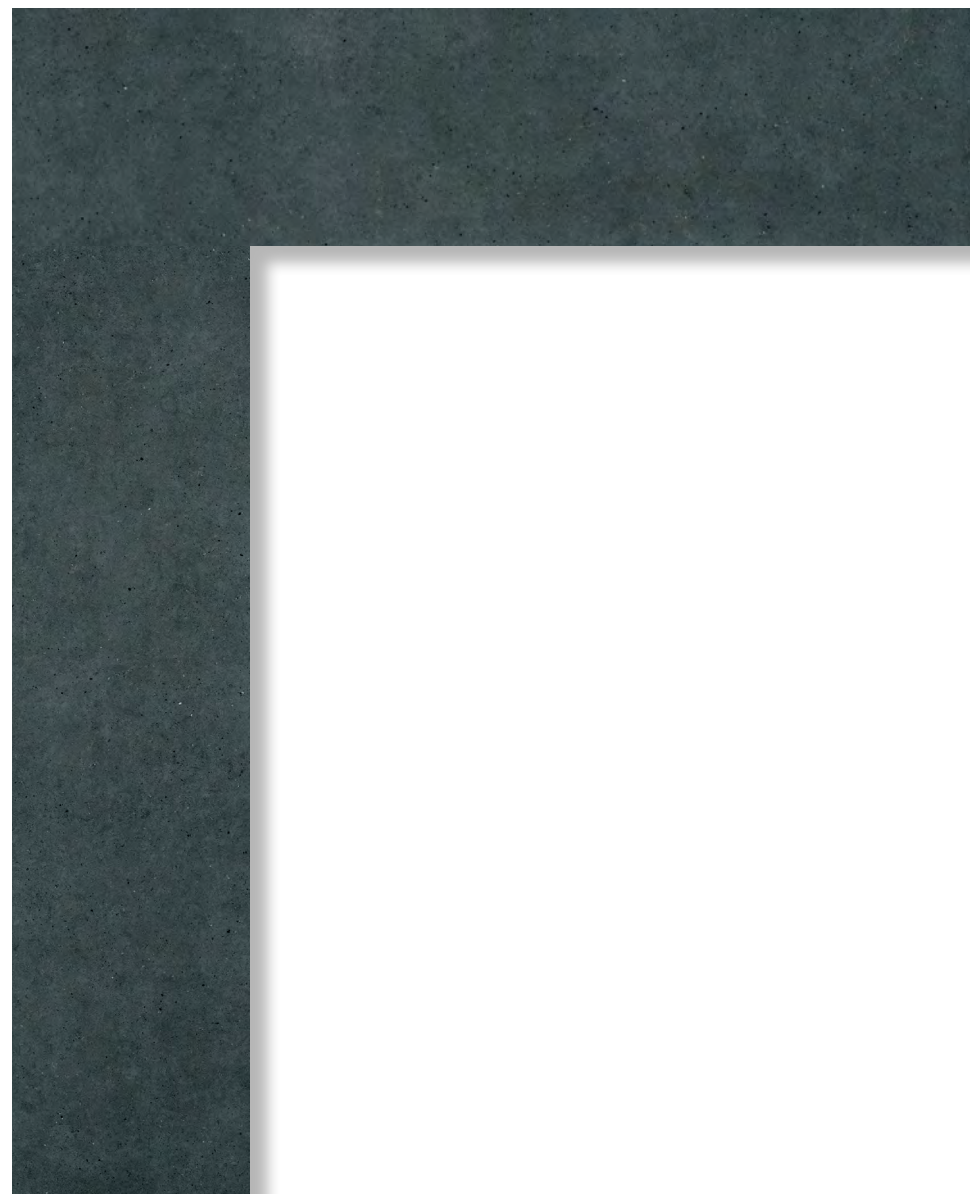

## 220 Magnate | Pattern continuity countertop to backsplash

1.

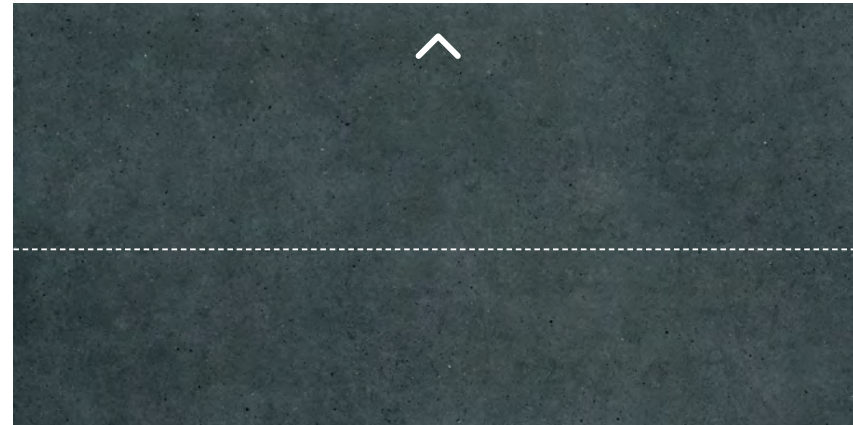

Cut the slab lengthwise

2.

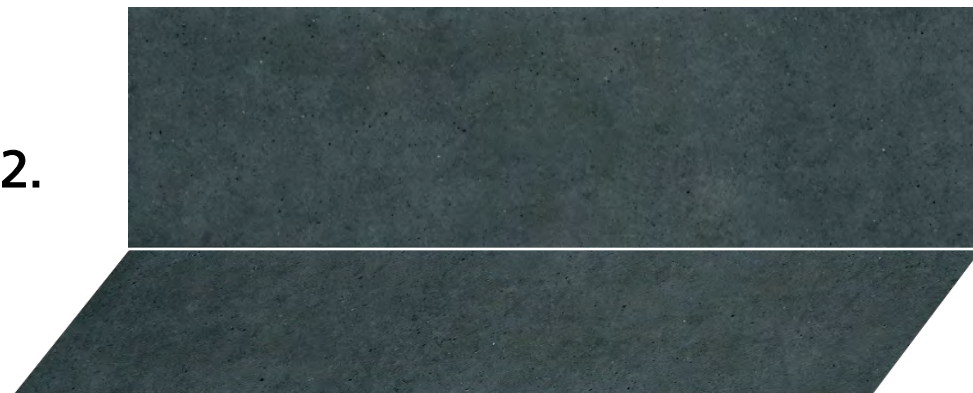

End result



220 Magnate | End result

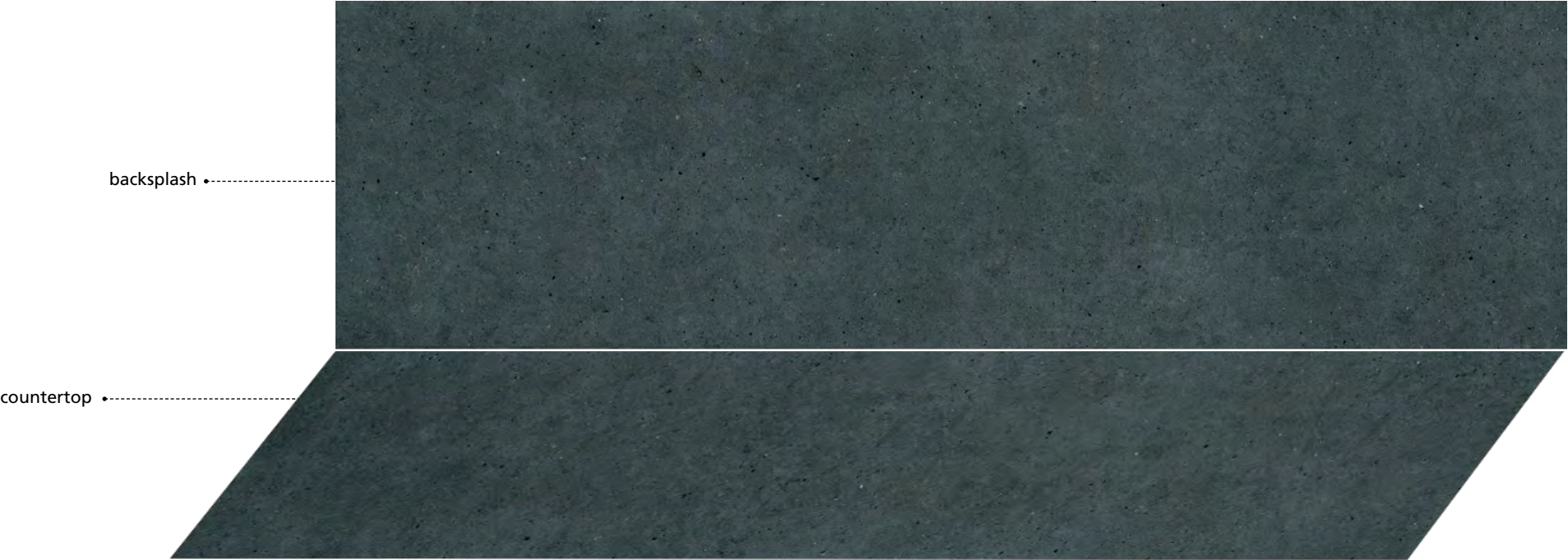

# 410 Aluminous | Releasing slab tension

Full Slab

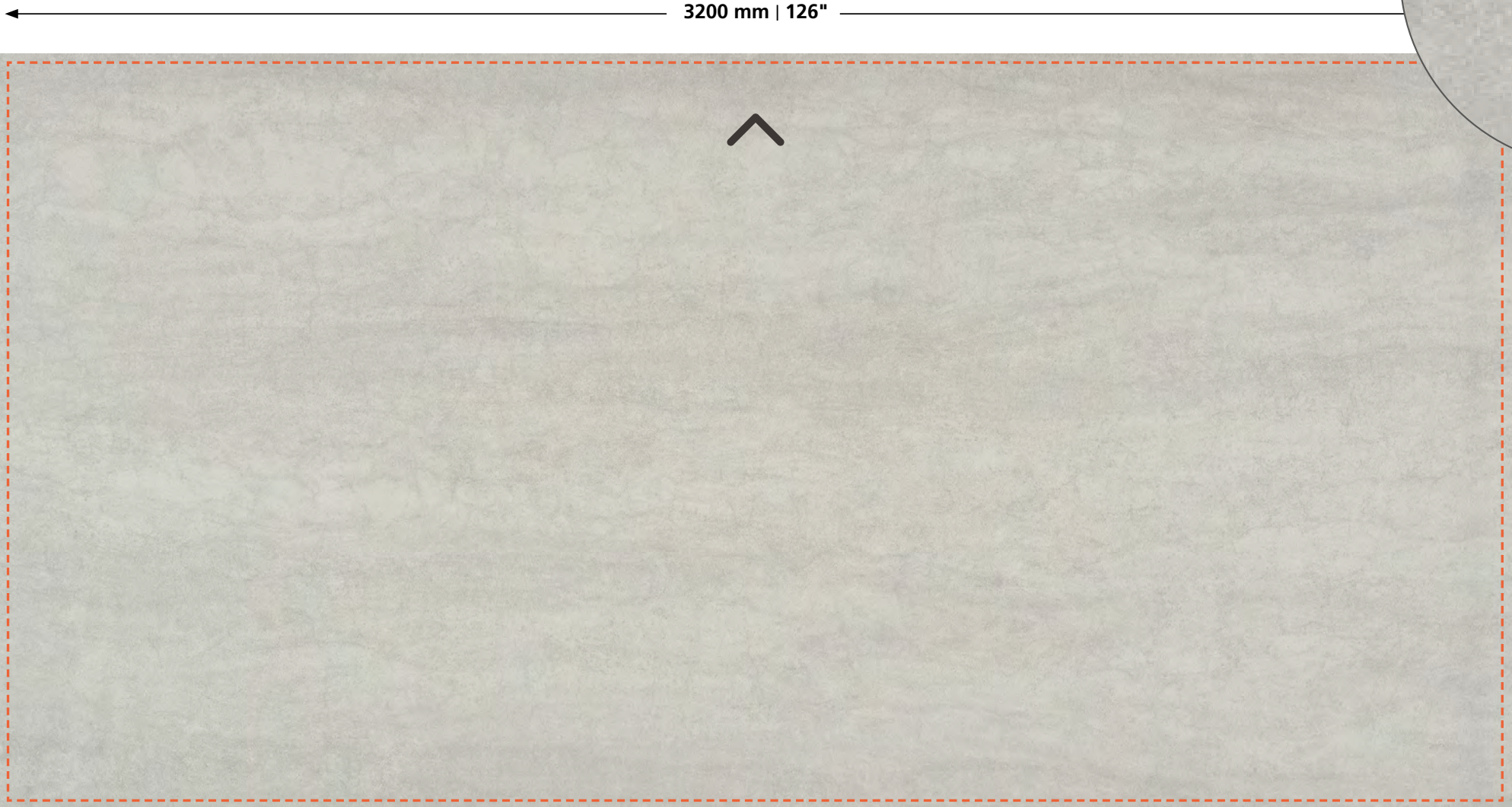

Reduce the 4 sides of the perimeter at a distance of 20-30 mm from the edges to release tension.

The useable slab size after releasing tension is 3160/3140 mm X 1560/1540 mm. (124<sup>3</sup>/<sub>8</sub>"/123<sup>5</sup>/<sub>8</sub>" X 61<sup>1</sup>/<sub>2</sub>"/60<sup>5</sup>/<sub>8</sub>" )

1600 mm | 63"

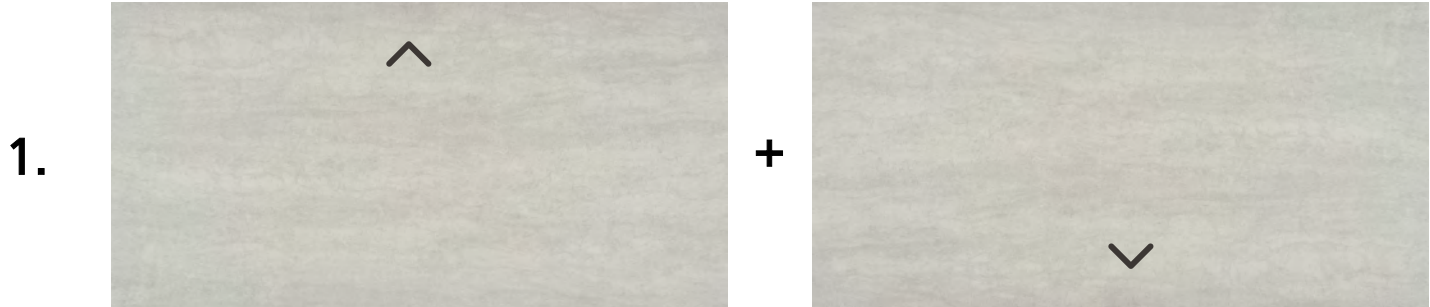

Rotate one slab 180°



End result

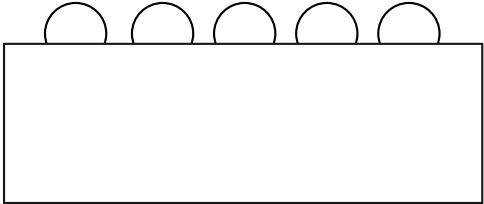

410 Aluminous | End result

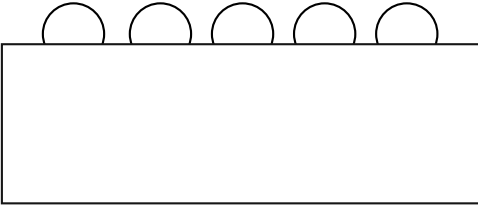

410 Aluminous | Pattern continuity plan

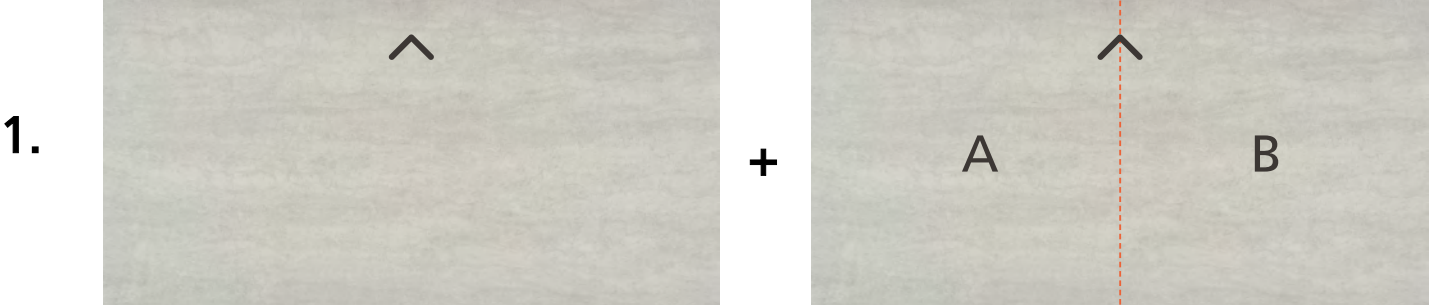

Cut the slab widthwise



Rotate part A 180° and join parts A & B to the full slab



End result

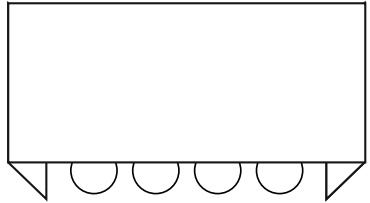

# 410 Aluminous | End result

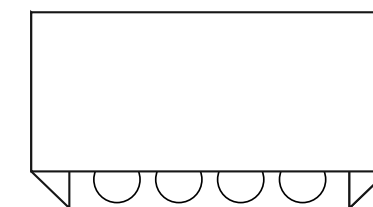
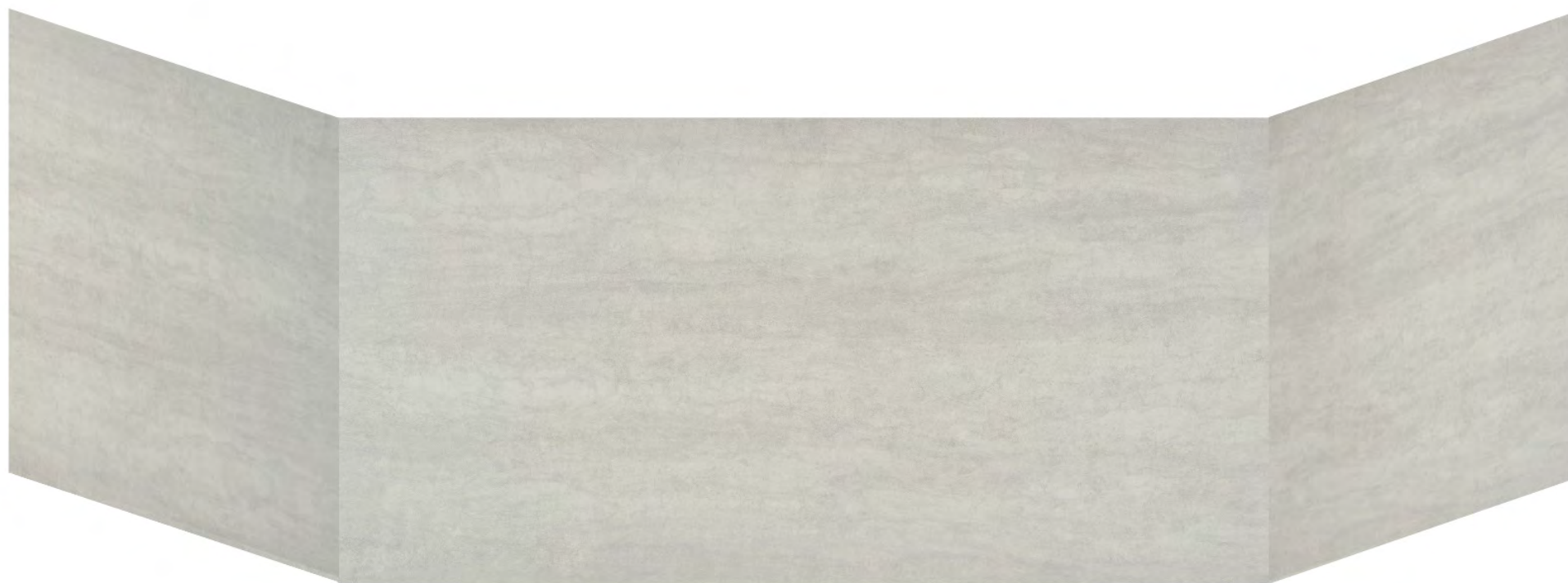

# 410 Aluminous | Pattern continuity plan

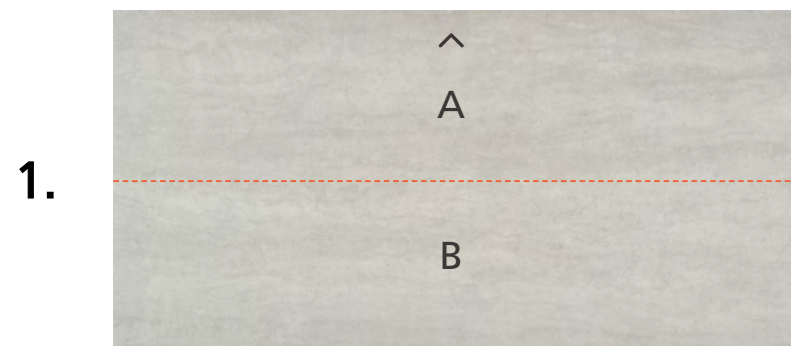

Cut the slab lengthwise

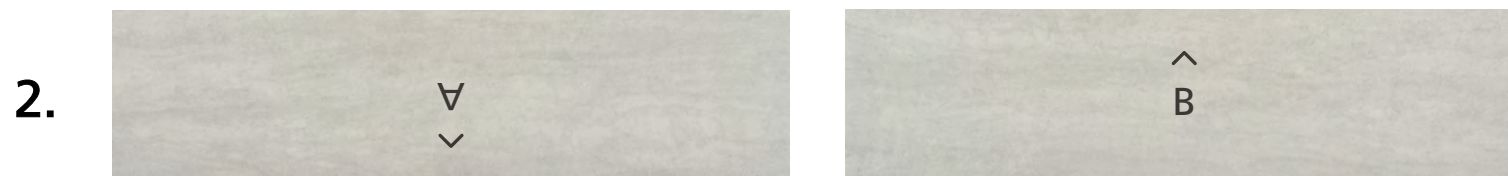

Rotate part A 180° and join parts A & B

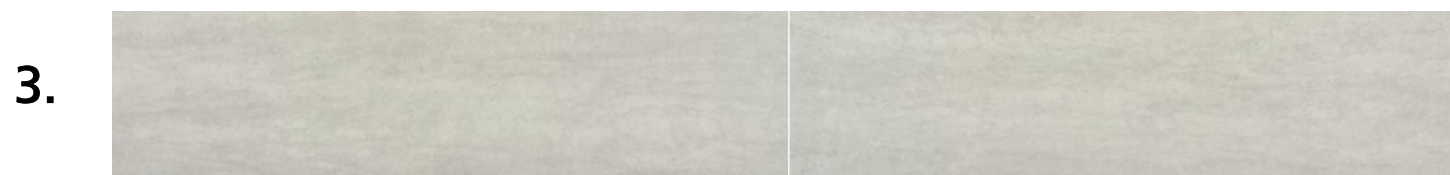

End result

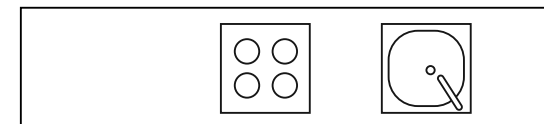

# 410 Aluminous | End result

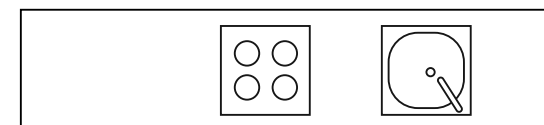
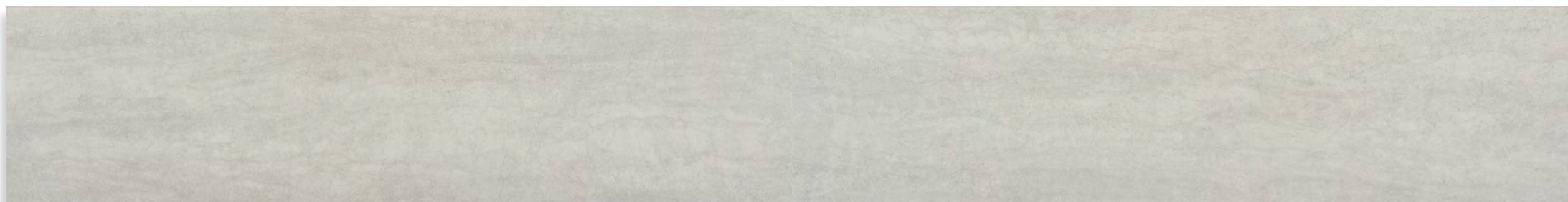

# 410 Aluminous | Pattern continuity L-shape

1.

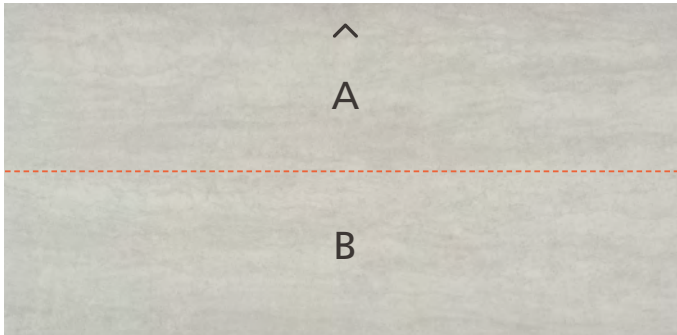

Cut the slab lengthwise

2.

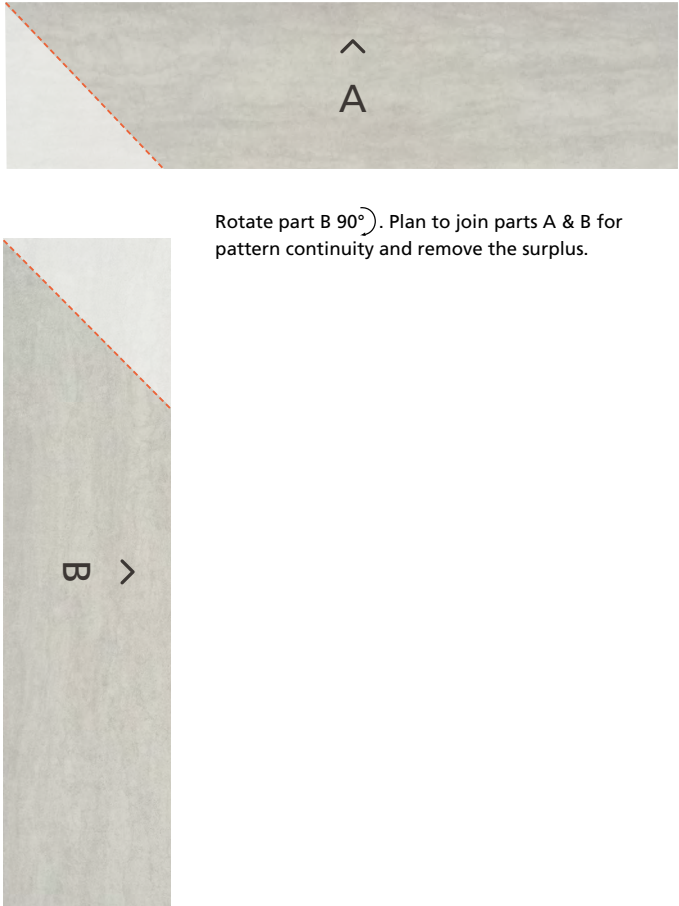

3.

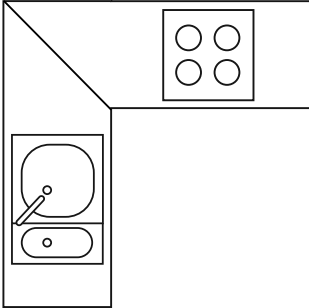
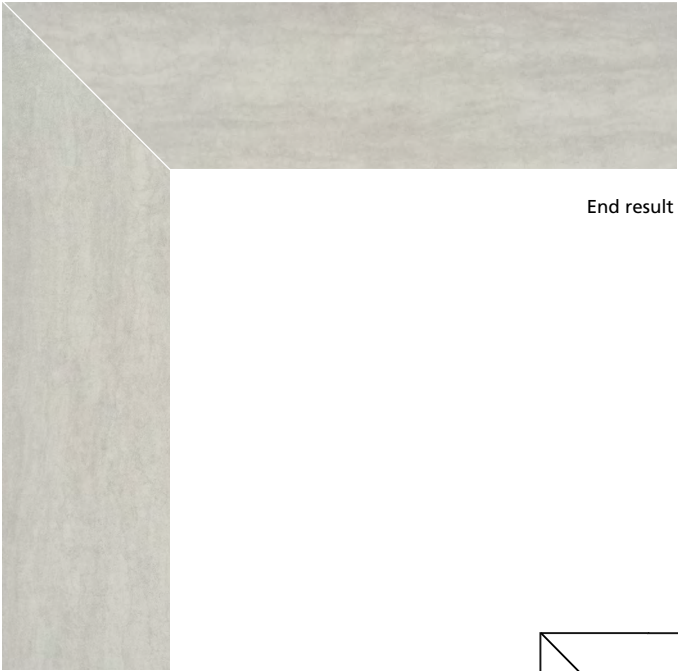

410 Aluminous | End result

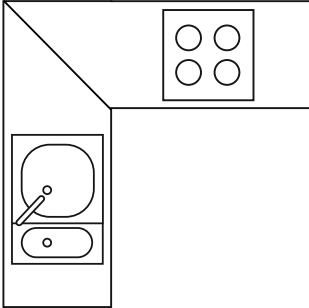

410 Aluminous | Pattern continuity countertop to backsplash

1.

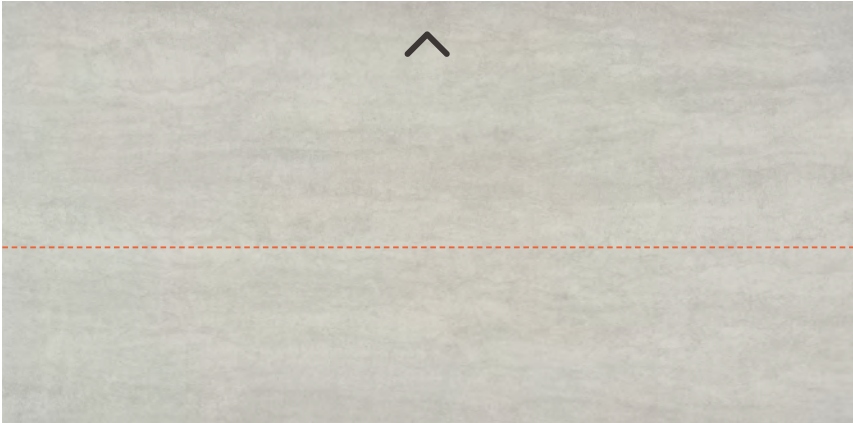

Cut the slab lengthwise

2.



End result



410 Aluminous | End result



# 411 Concrita | Releasing slab tension

Full Slab

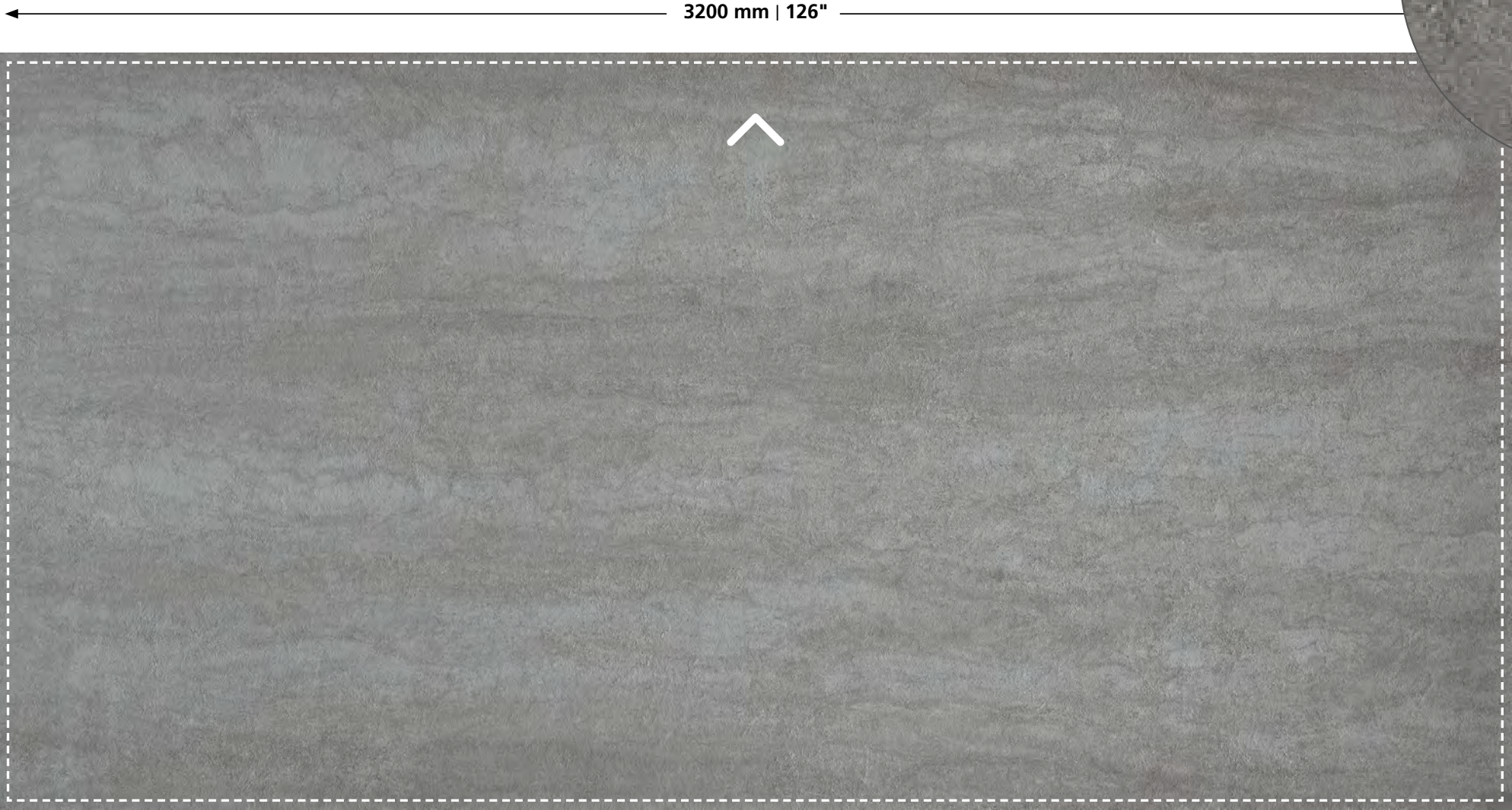

Reduce the 4 sides of the perimeter at a distance of 20-30 mm from the edges to release tension.

The useable slab size after releasing tension is 3160/3140 mm X 1560/1540 mm. (124<sup>3</sup>/<sub>8</sub>"/123<sup>5</sup>/<sub>8</sub>" X 61<sup>1</sup>/<sub>2</sub>"/60<sup>5</sup>/<sub>8</sub>" )

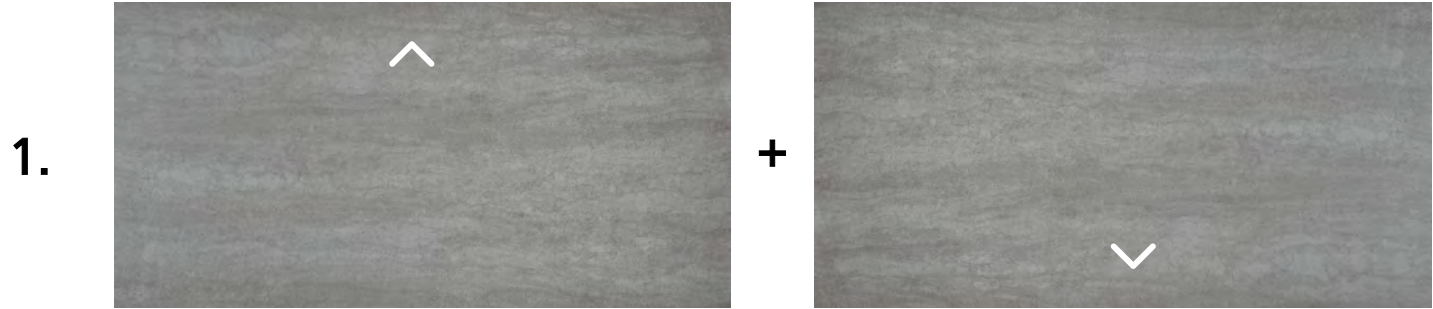

Rotate one slab 180°



End result

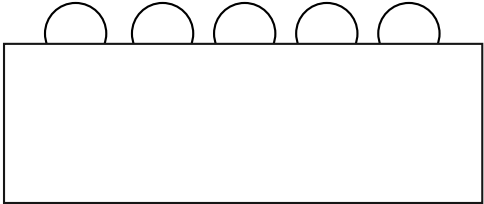

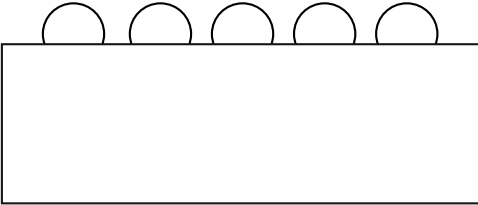

411 Concrita | Pattern continuity plan

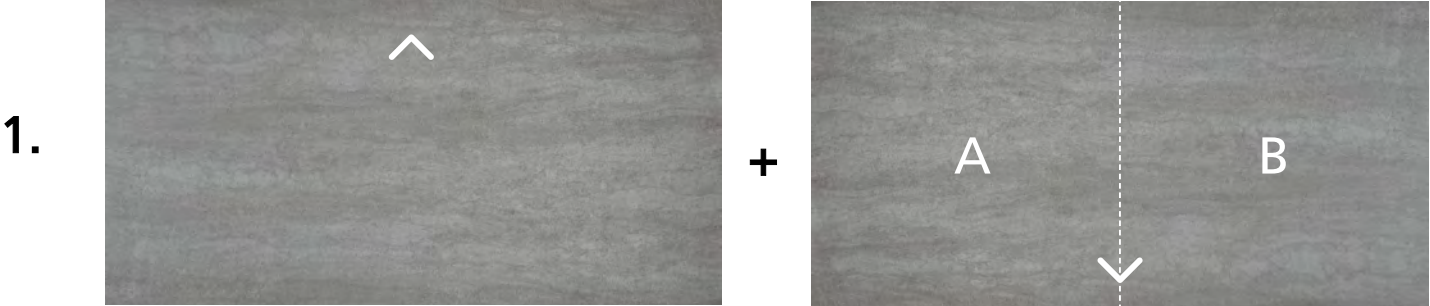

Rotate one slab 180° and cut widthwise



Join parts A & B to the full slab



End result

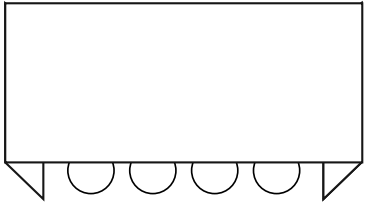

411 Concrita | End result

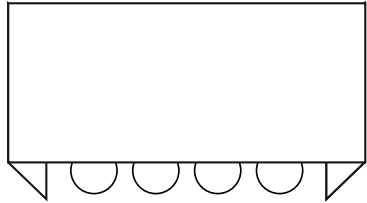

# 411 Concrita | Pattern continuity plan

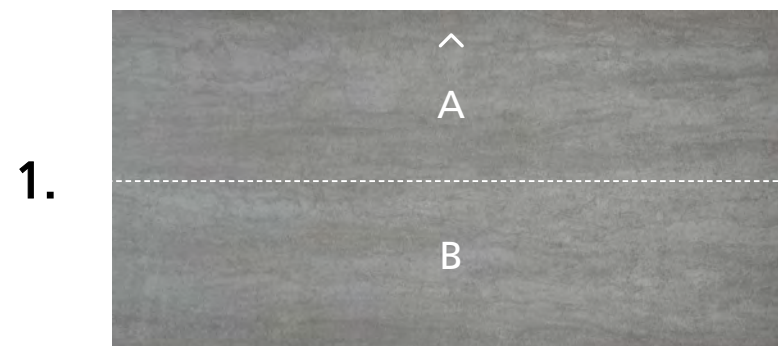

Cut the slab lengthwise



Rotate part A 180° and join parts A & B to the full slab



End result

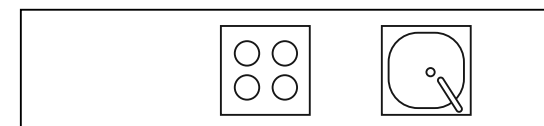

# 411 Concrita | End result

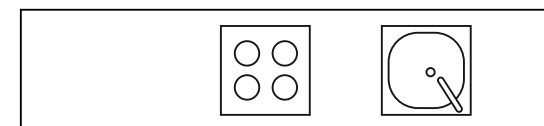

# 411 Concrita | Pattern continuity L-shape

1.

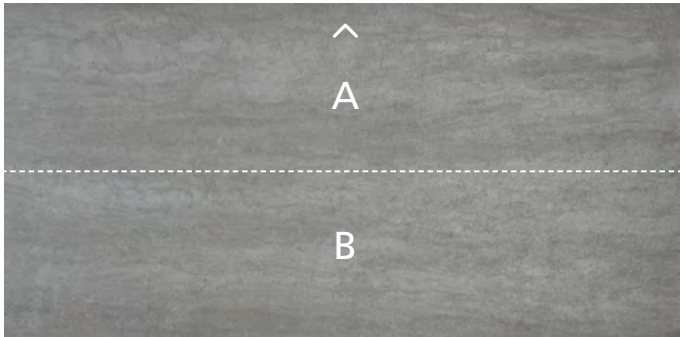

Cut the slab lengthwise

2.

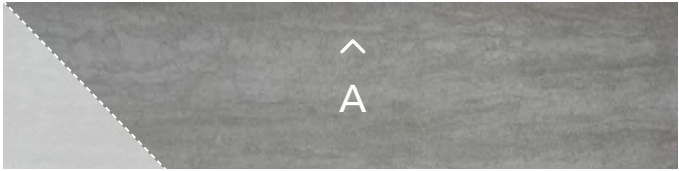

Rotate part B 90°. Plan to join parts A & B for pattern continuity and remove the surplus.



3.

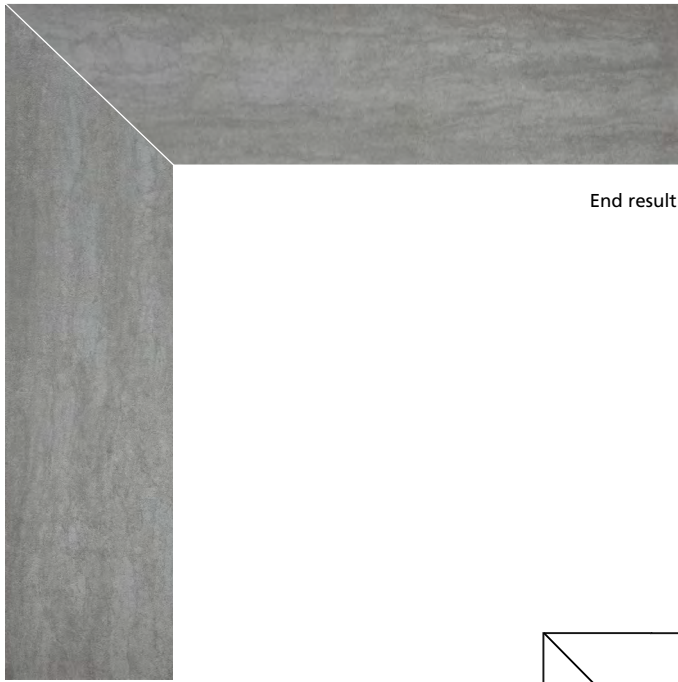

End result

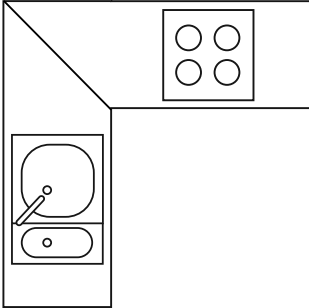

411 Concrita | End result

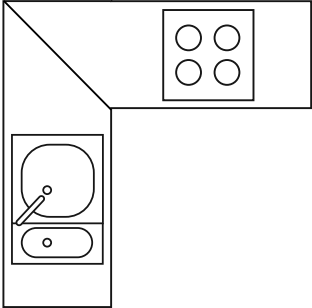

411 Concrita | Pattern continuity countertop to backsplash

1.

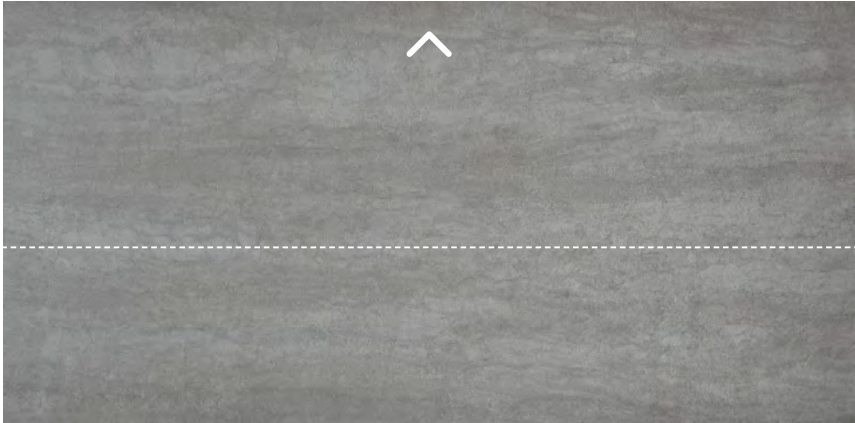

Cut the slab lengthwise

2.



End result



411 Concrita | End result



# 412 Beige Ciment | Releasing slab tension

Full Slab



Reduce the 4 sides of the perimeter at a distance of 20-30 mm from the edges to release tension.

The useable slab size after releasing tension is 3160/3140 mm X 1560/1540 mm. (124<sup>3</sup>/<sub>8</sub>"/123<sup>5</sup>/<sub>8</sub>" X 61<sup>1</sup>/<sub>2</sub>"/60<sup>5</sup>/<sub>8</sub>" )

# 412 Beige Ciment | Pattern continuity plan

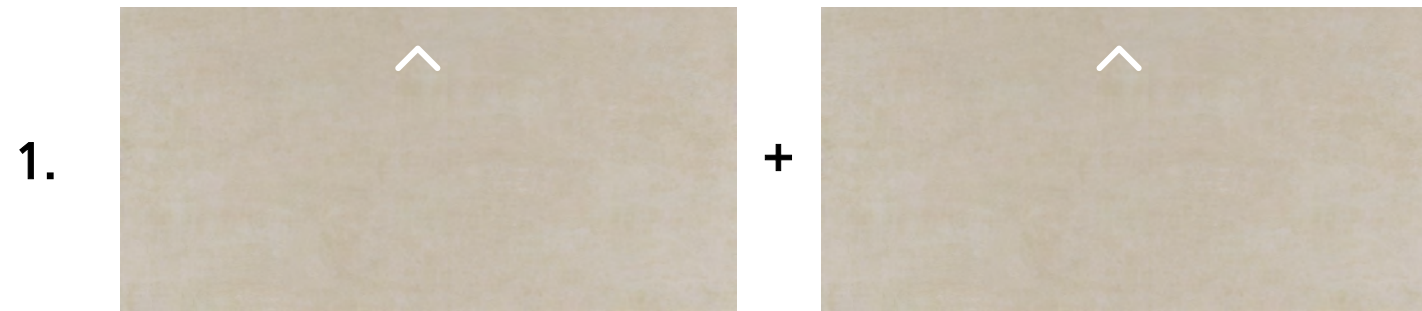

Plan to join the two slabs for pattern continuity and remove the surplus



End result

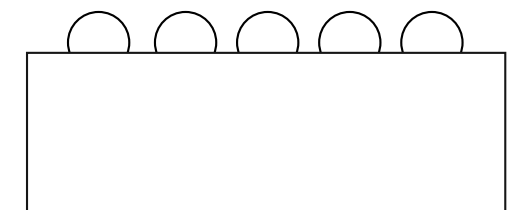

412 Beige Ciment | End result

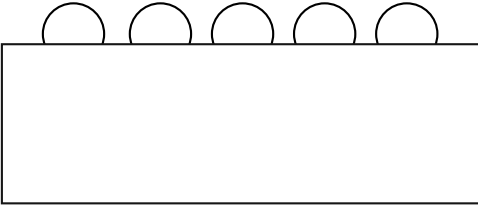

# 412 Beige Ciment | Pattern continuity plan

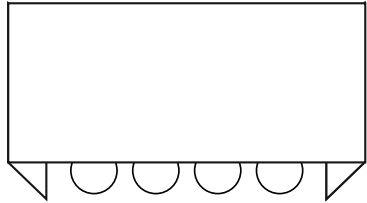
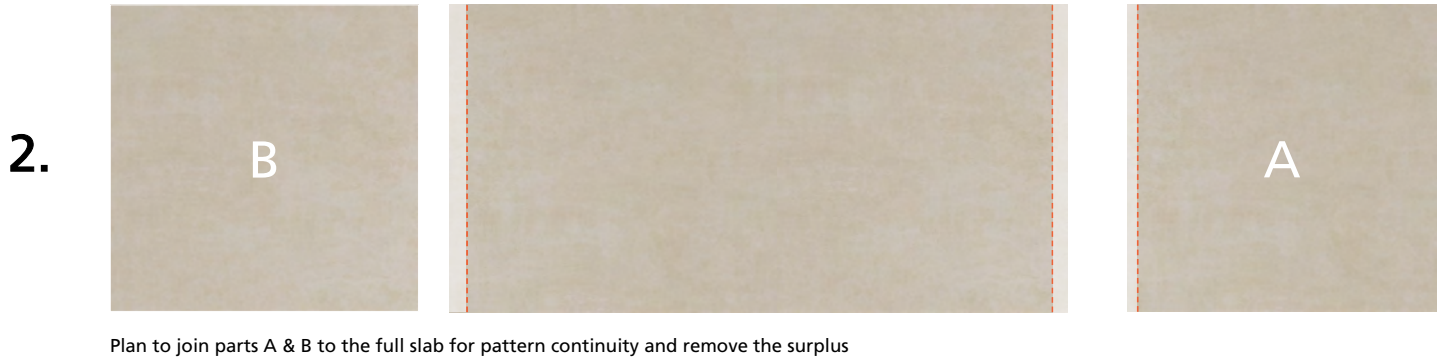
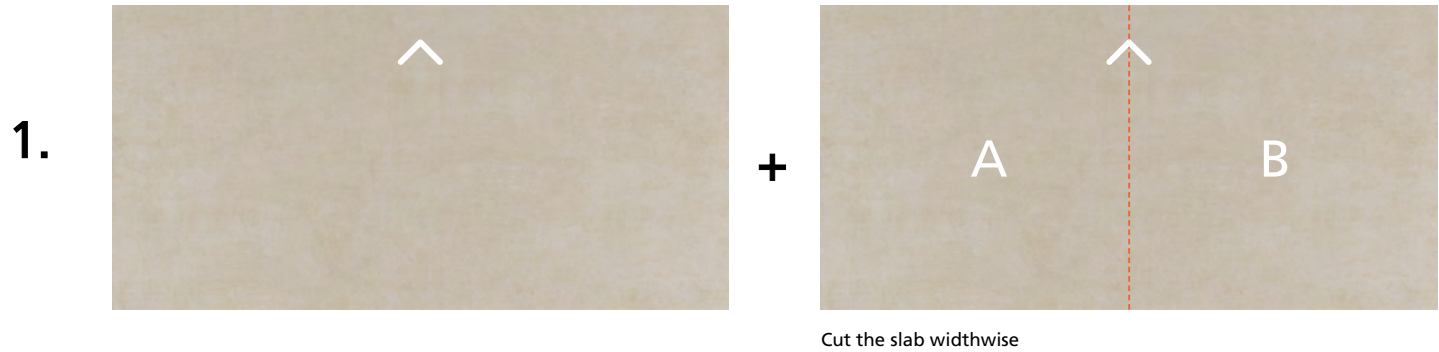

# 412 Beige Ciment | End result

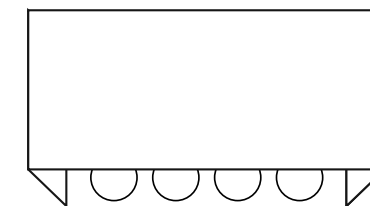
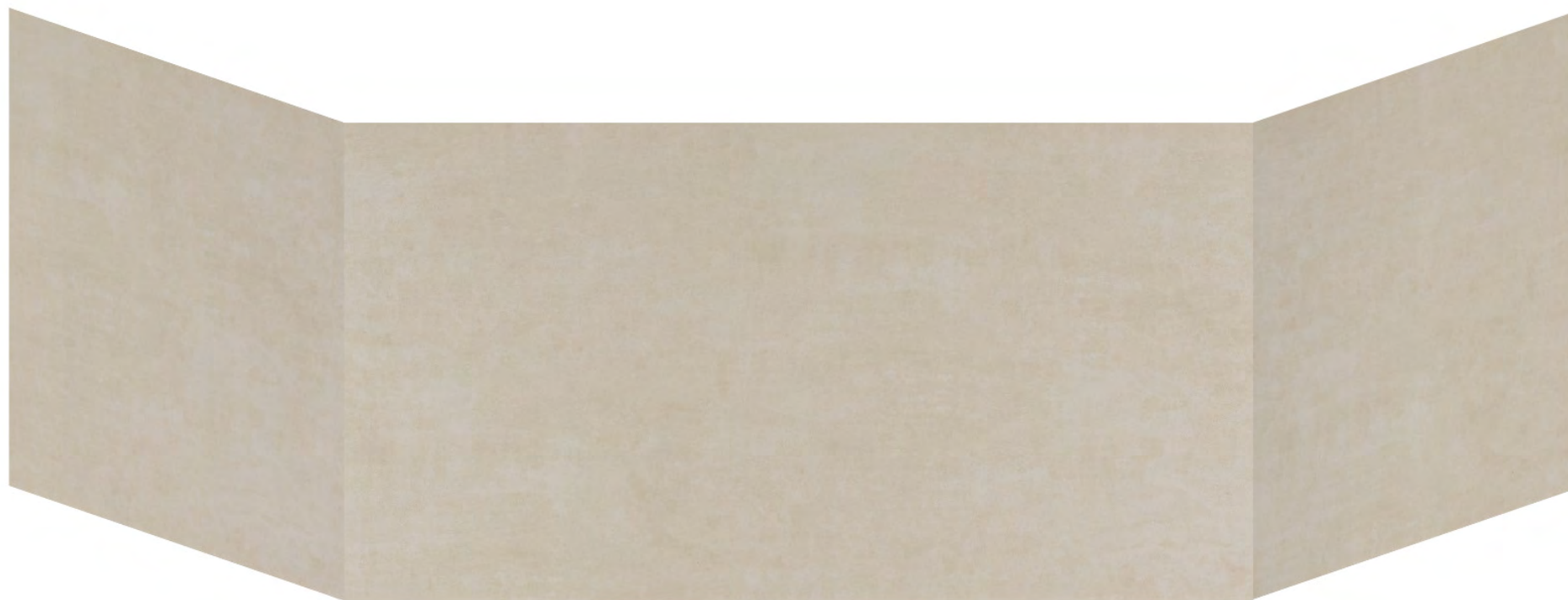

# 412 Beige Ciment | Pattern continuity plan

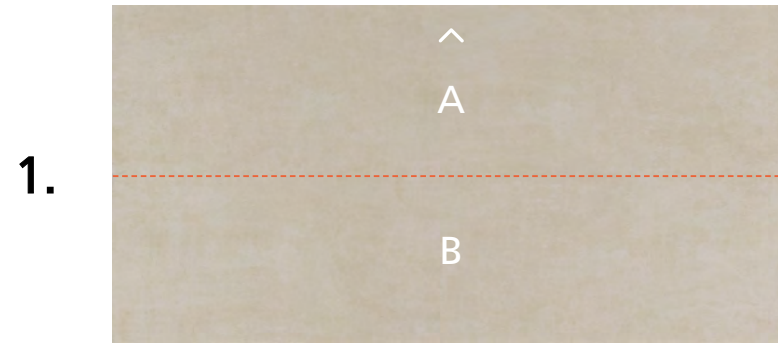

Cut the slab lengthwise

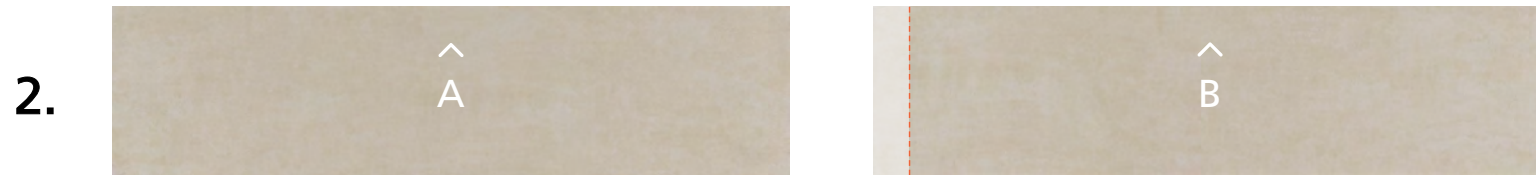

Plan to join parts A & B for pattern continuity and remove the surplus

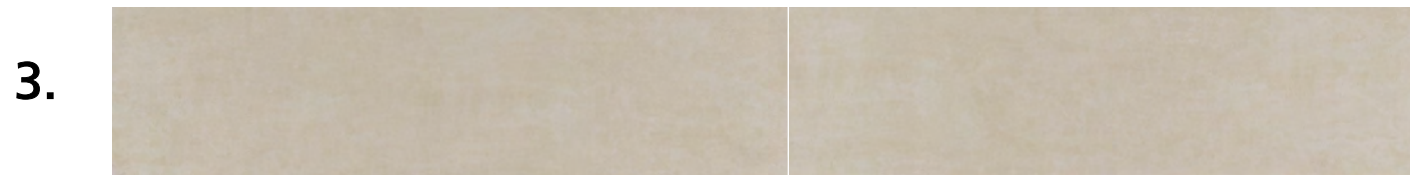

End result

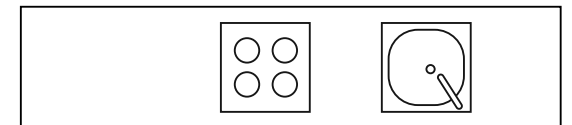

## 412 Beige Ciment | End result

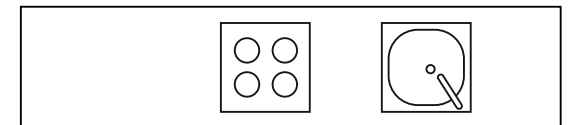

# 412 Beige Ciment | Pattern continuity L-shape

1.

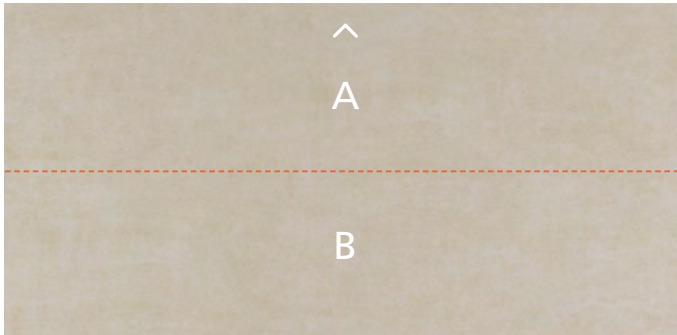

Cut the slab lengthwise

2.

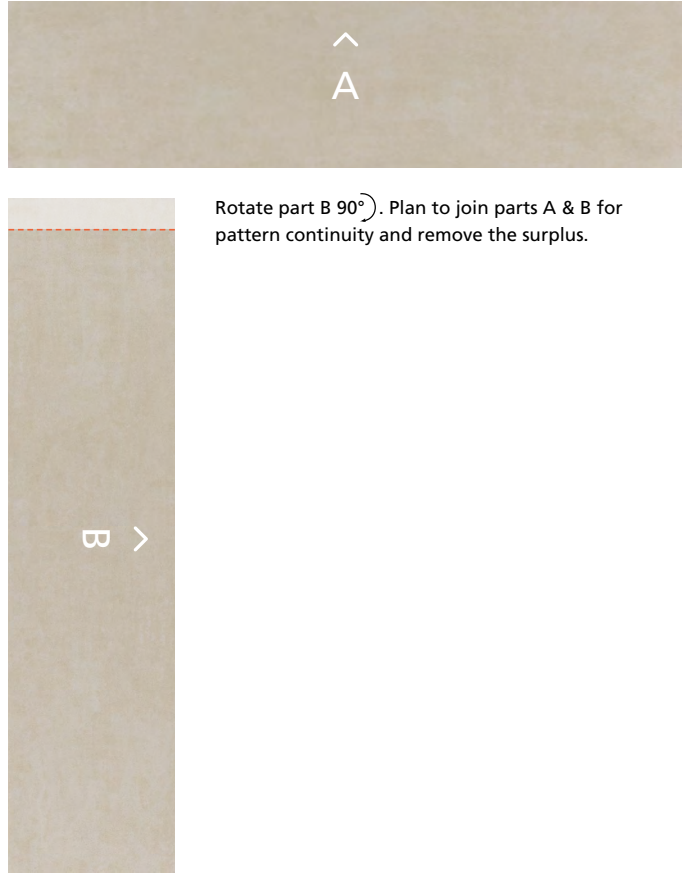

3.

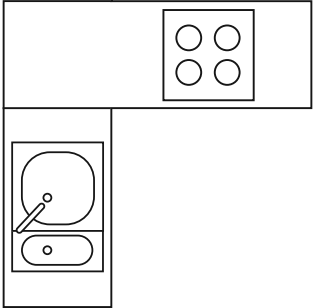

# 412 Beige Ciment | End result

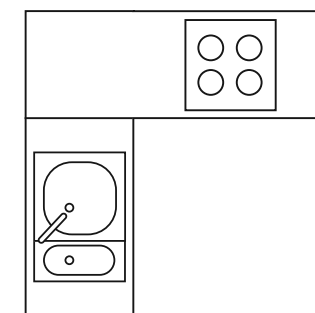

412 Beige Ciment | Pattern continuity countertop to backsplash

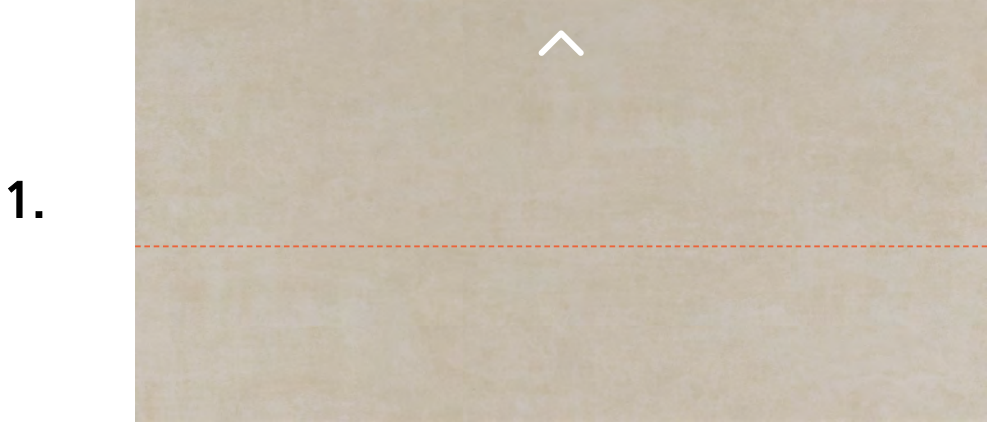

Cut the slab lengthwise



End result



412 Beige Ciment | End result



# 413 White Ciment | Releasing slab tension

Full Slab

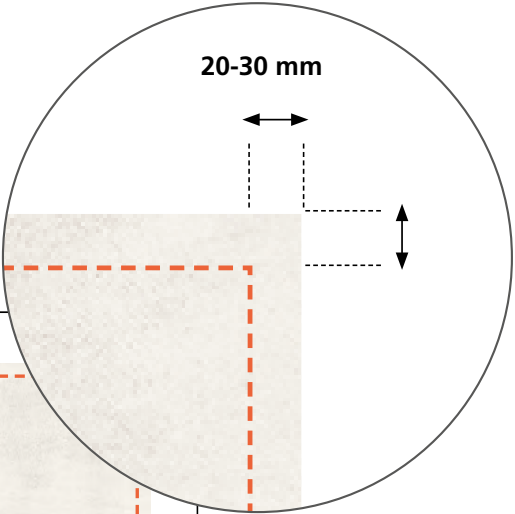
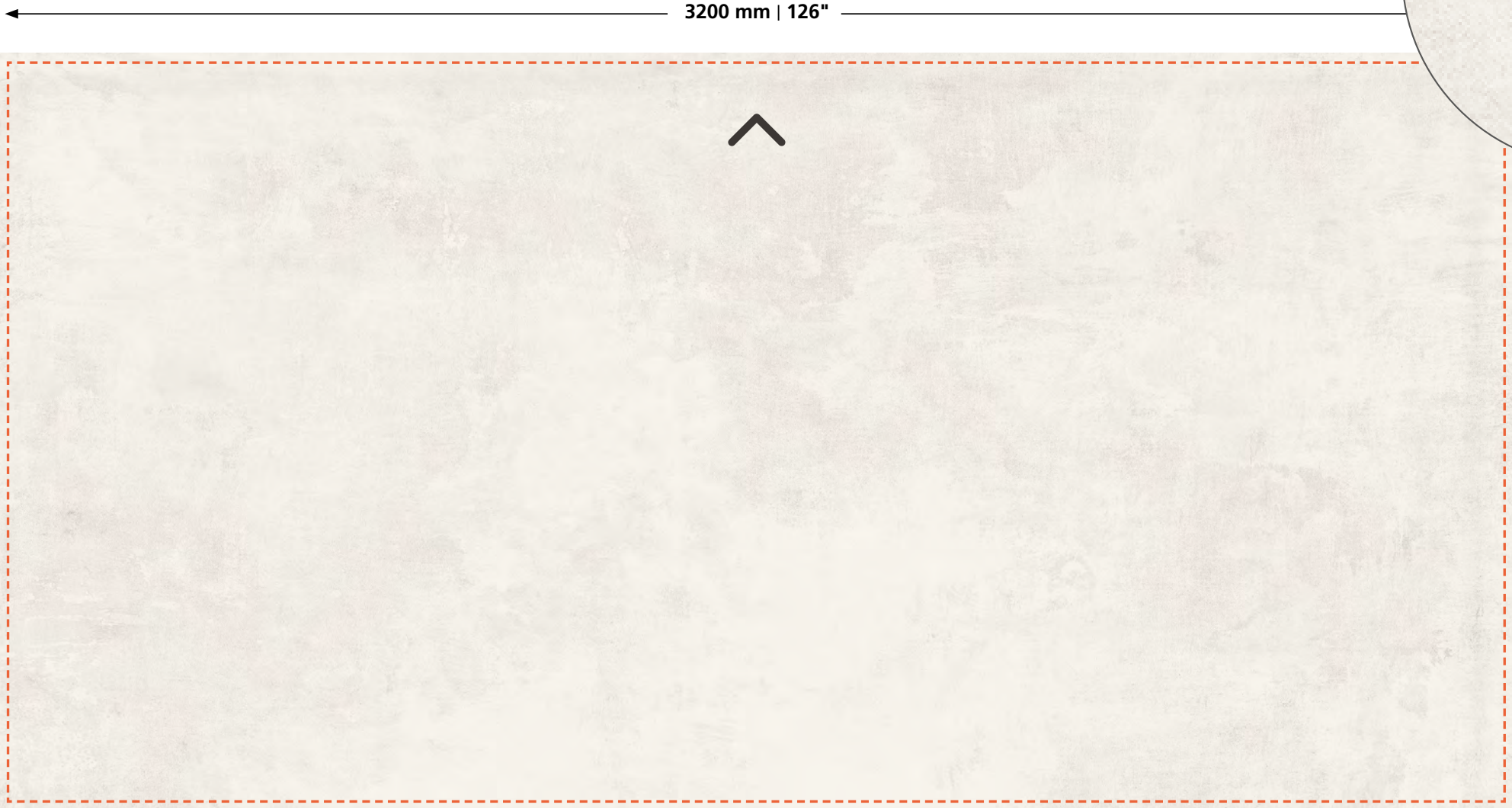

Reduce the 4 sides of the perimeter at a distance of 20-30 mm from the edges to release tension.

The useable slab size after releasing tension is 3160/3140 mm X 1560/1540 mm. (124<sup>3</sup>/<sub>8</sub>"/123<sup>5</sup>/<sub>8</sub>" X 61<sup>1</sup>/<sub>2</sub>"/60<sup>5</sup>/<sub>8</sub>" )

413 White Ciment | Pattern continuity plan

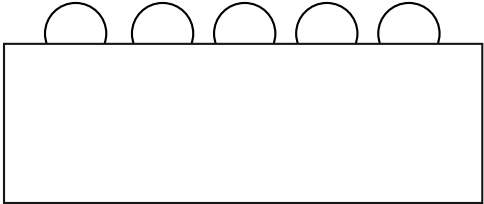
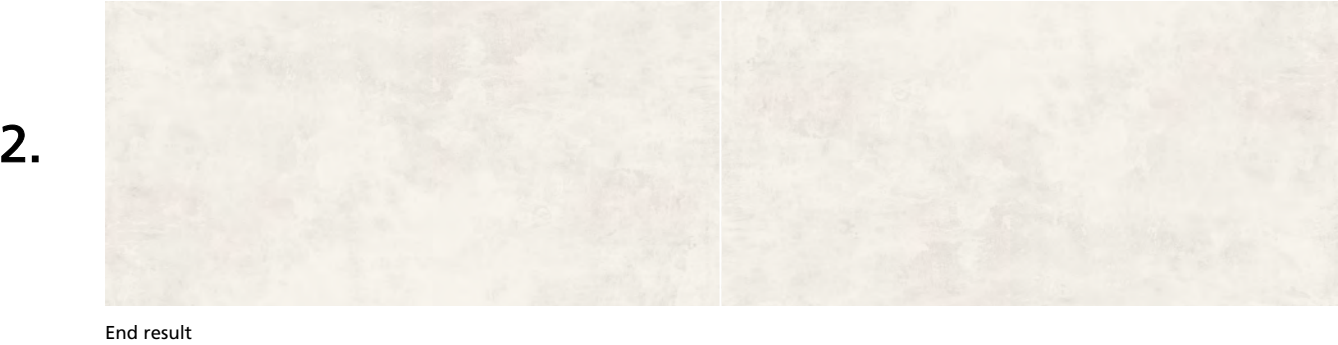
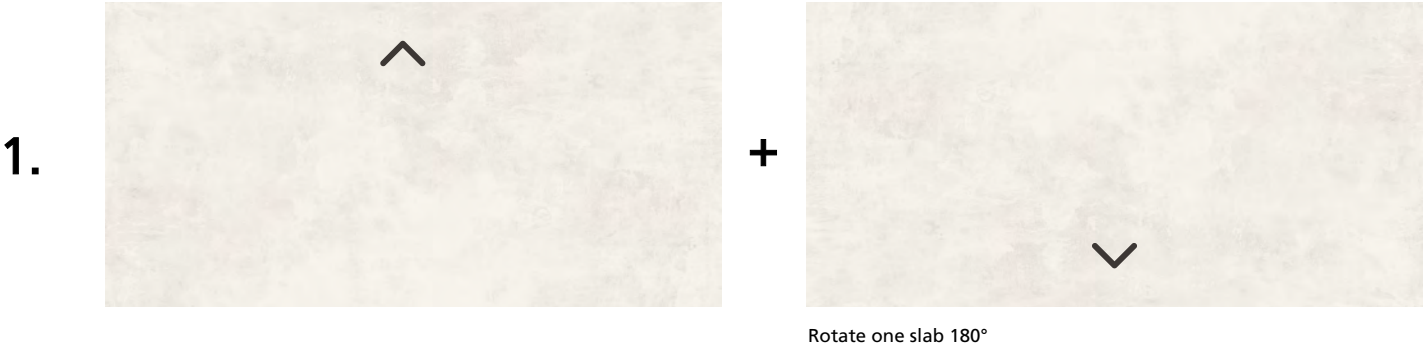

413 White Ciment | End result

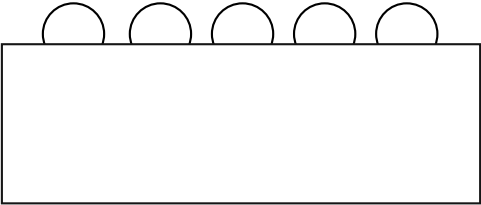

# 413 White Ciment | Pattern continuity plan

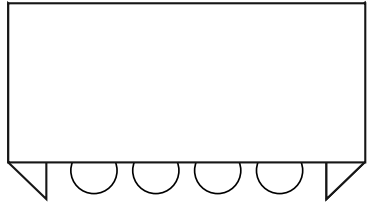
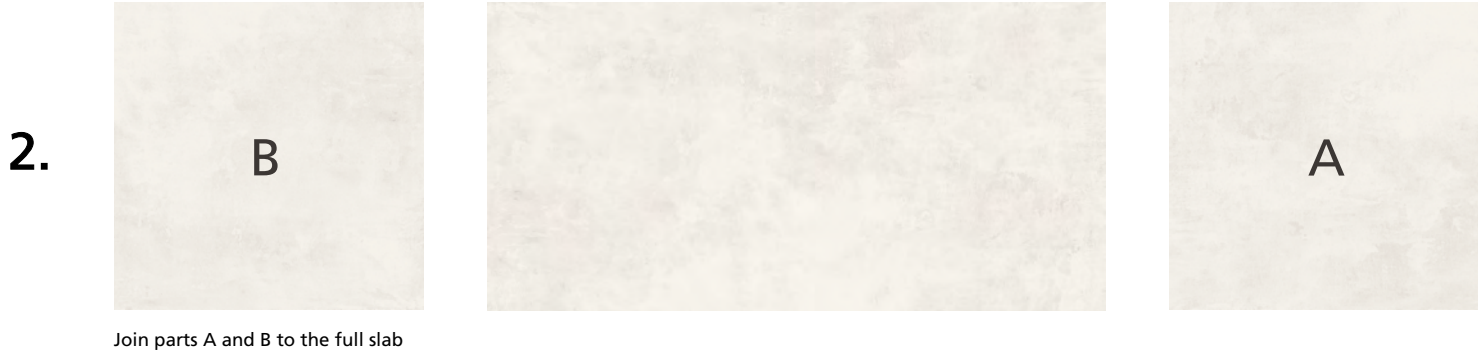
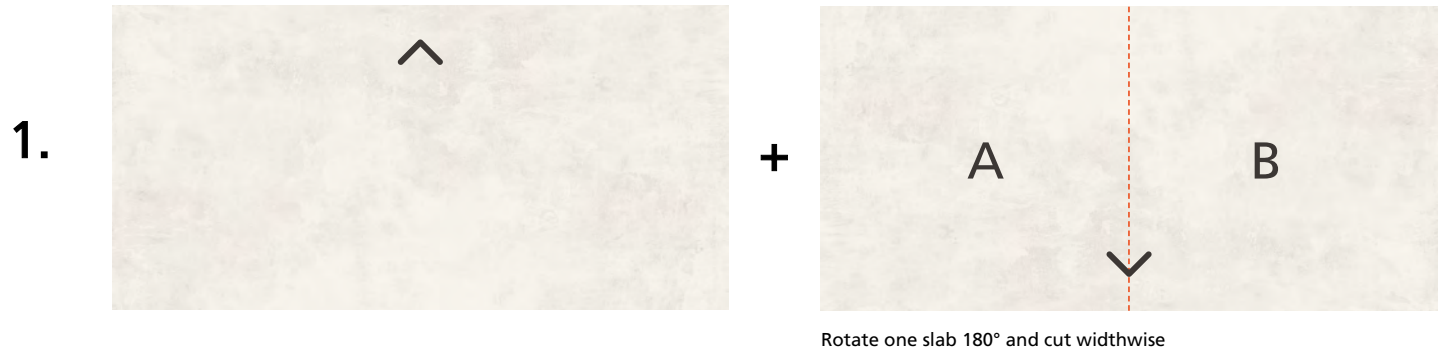

413 White Ciment | End result

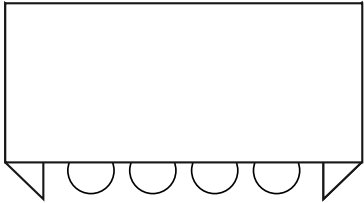
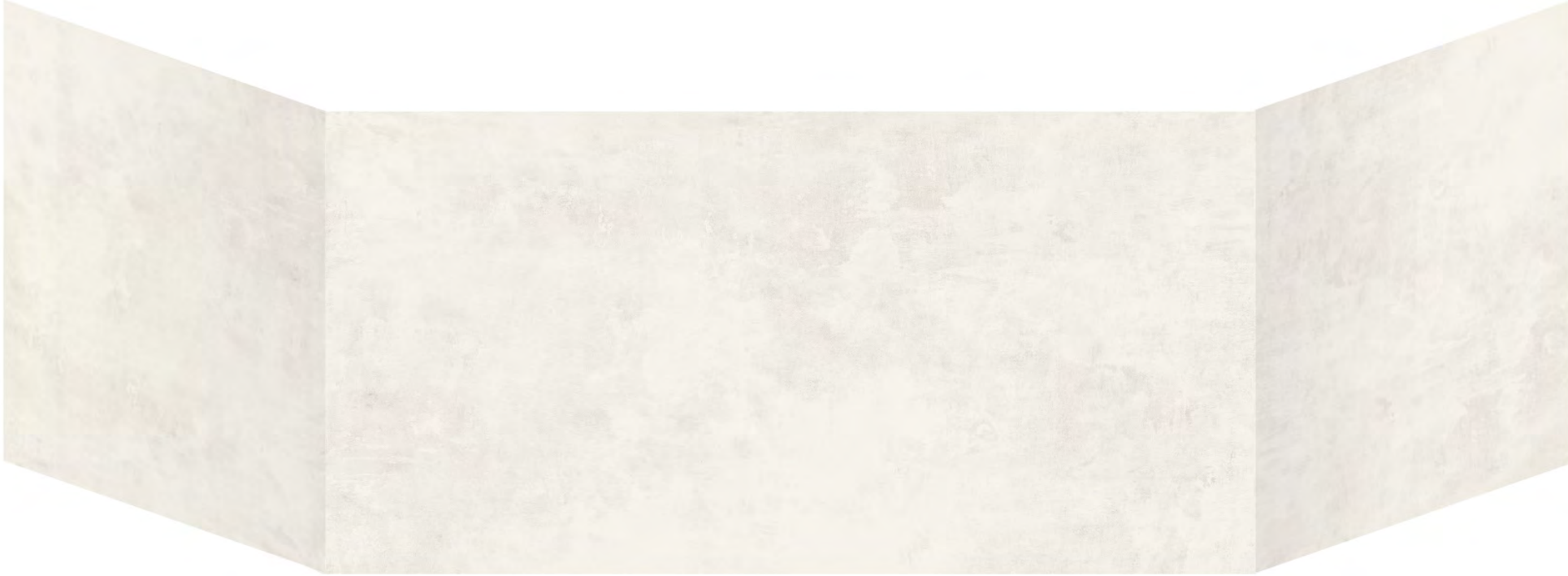

# 413 White Ciment | Pattern continuity plan

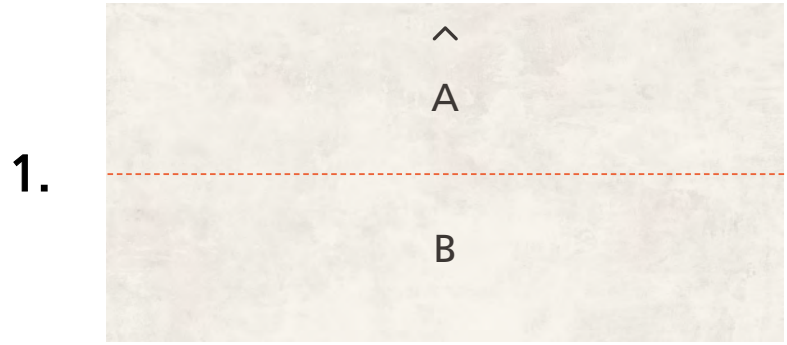

Cut the slab lengthwise



Rotate part B 180° and join parts A & B



End result

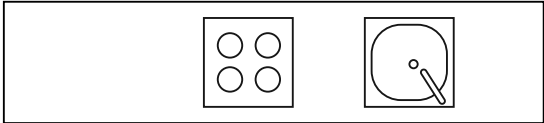

413 White Ciment | End result

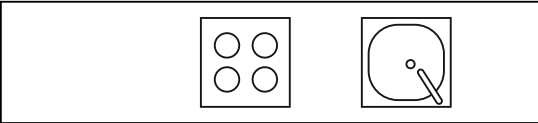
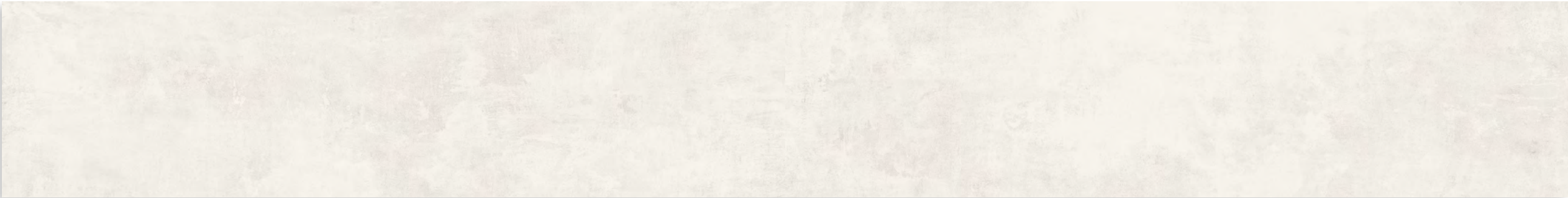

# 413 White Ciment | Pattern continuity L-shape

1.

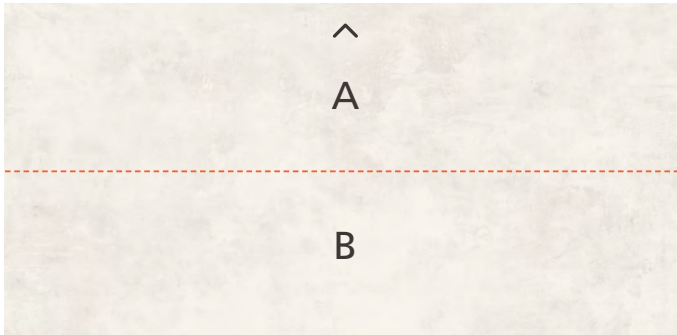

Cut the slab lengthwise

2.

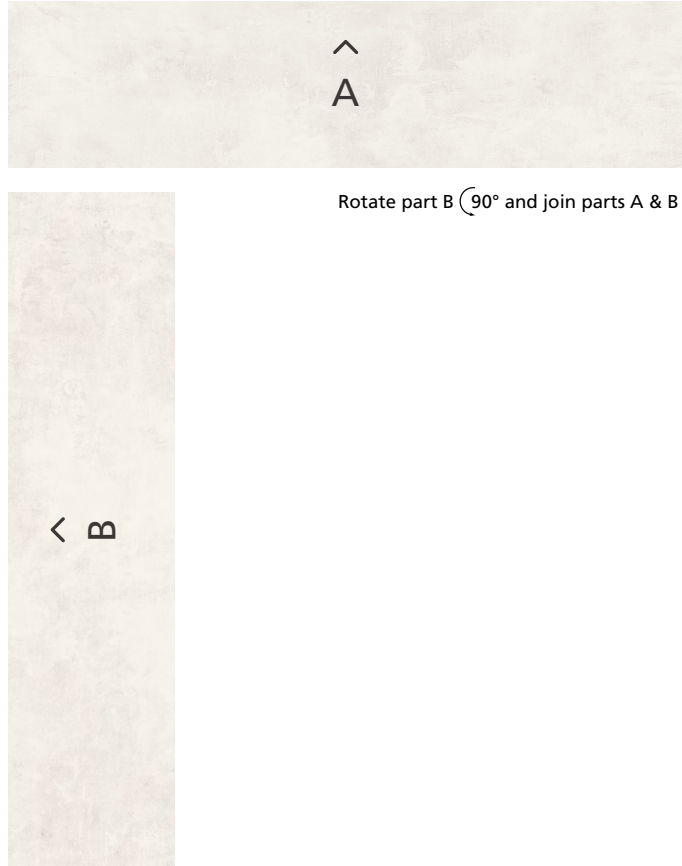

3.

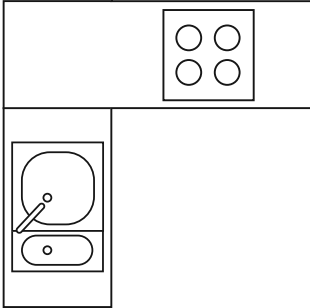
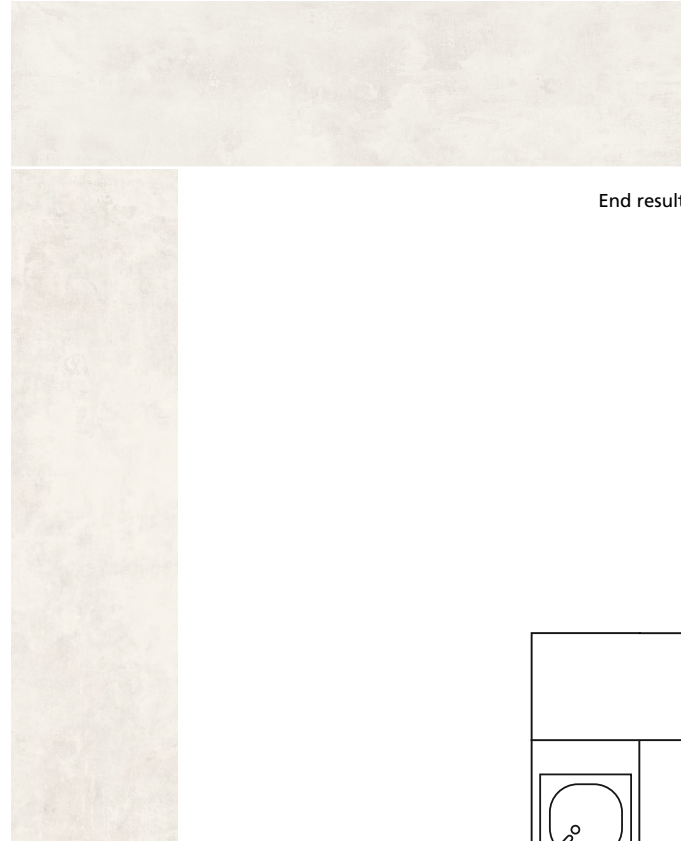

413 White Ciment | End result

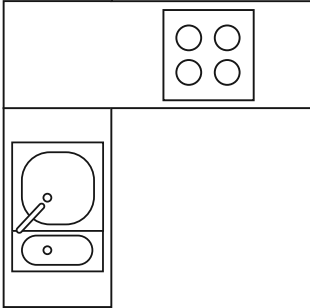
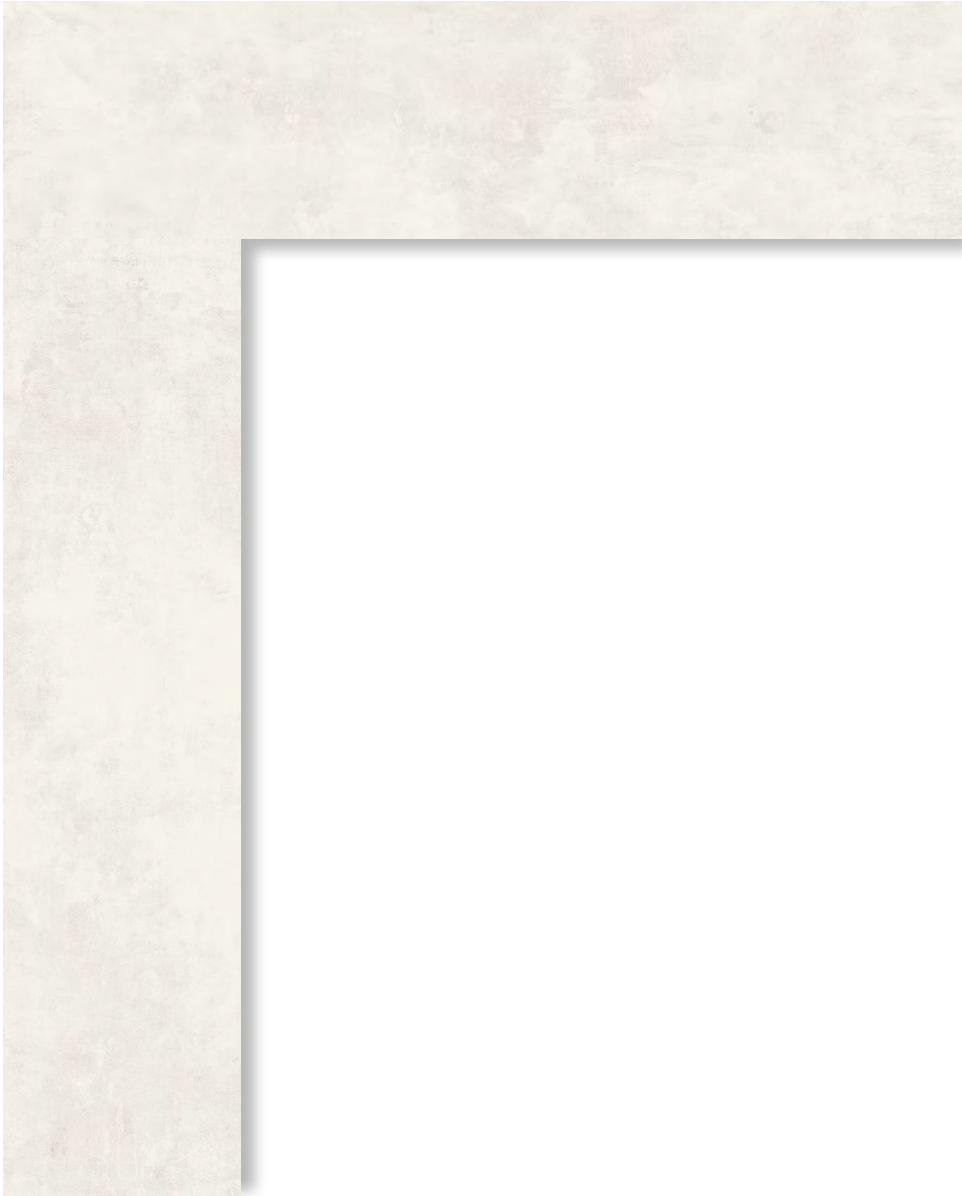

# 413 White Ciment | Pattern continuity countertop to backsplash

1.

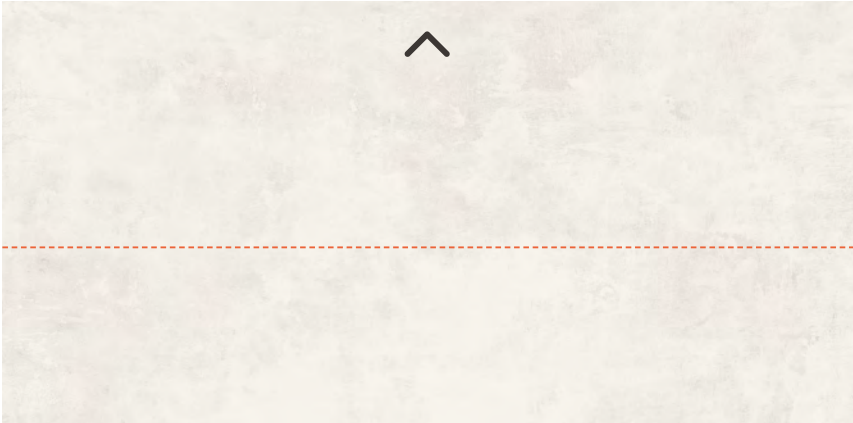

Cut the slab lengthwise

2.

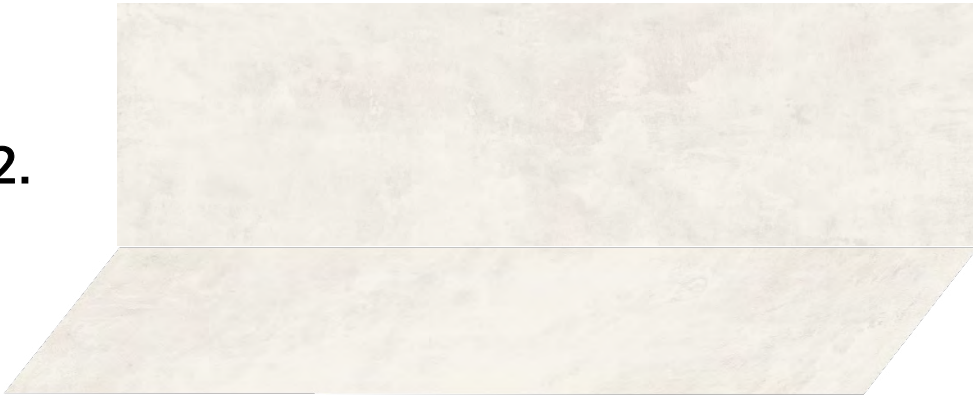

End result



# 413 White Ciment | End result

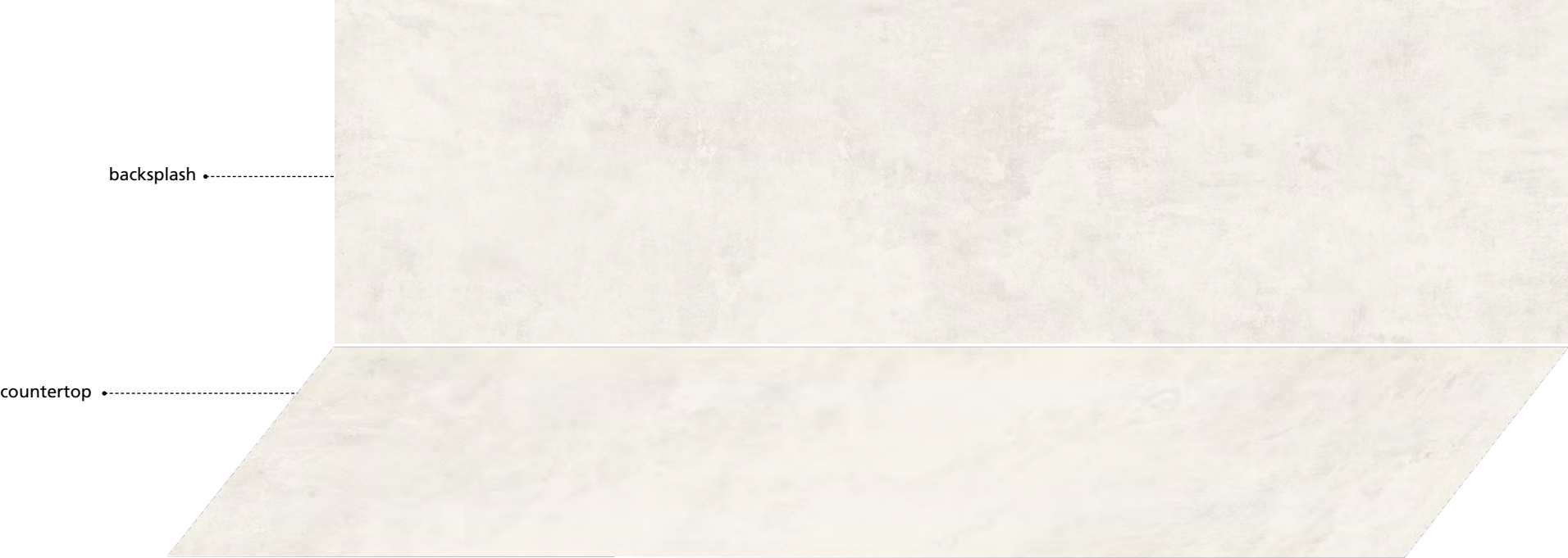

# 501 Snowdrift | Releasing slab tension

Full Slab

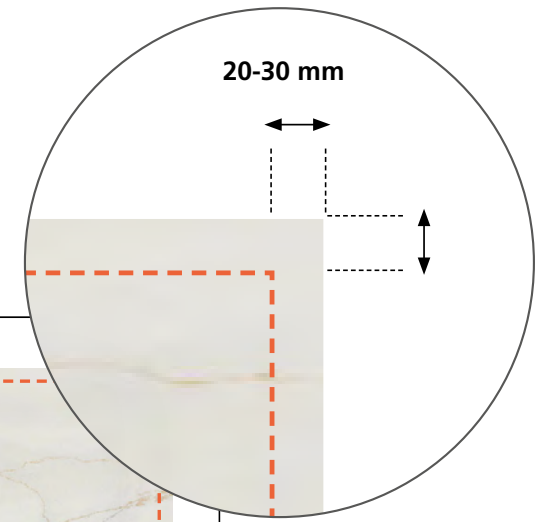
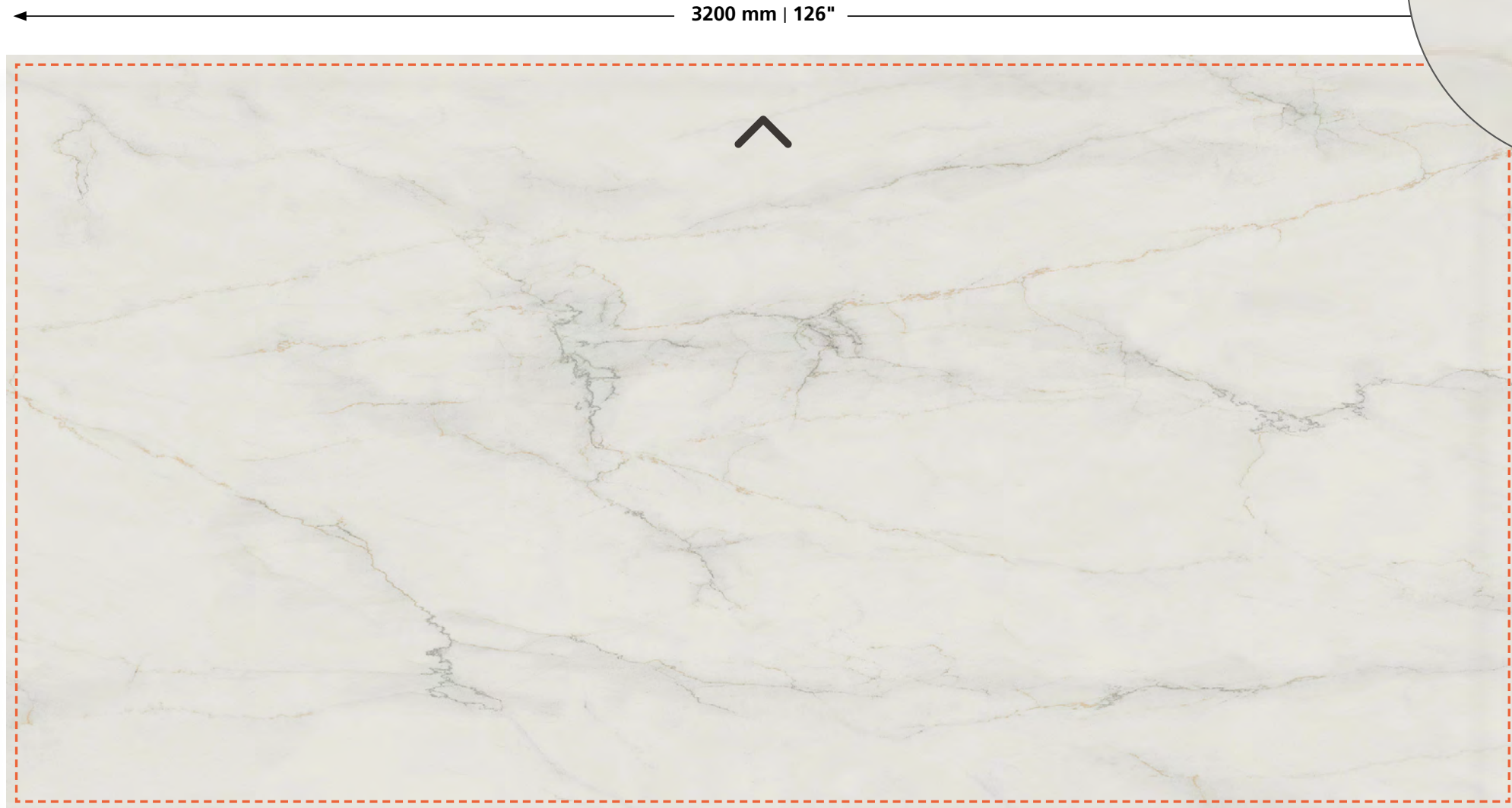

Reduce the 4 sides of the perimeter at a distance of 20-30 mm from the edges to release tension.

The useable slab size after releasing tension is 3160/3140 mm X 1560/1540 mm. (124<sup>3</sup>/<sub>8</sub>"/123<sup>5</sup>/<sub>8</sub>" X 61<sup>1</sup>/<sub>2</sub>"/60<sup>5</sup>/<sub>8</sub>" )

1600 mm | 63"

# 501 Snowdrift | Pattern continuity plan

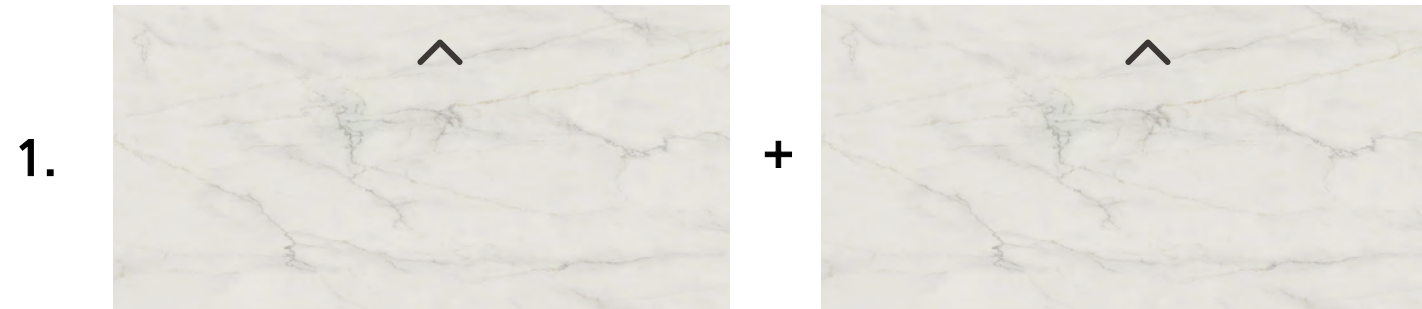

Plan to join the two slabs for continuation of the main veins and remove the surplus

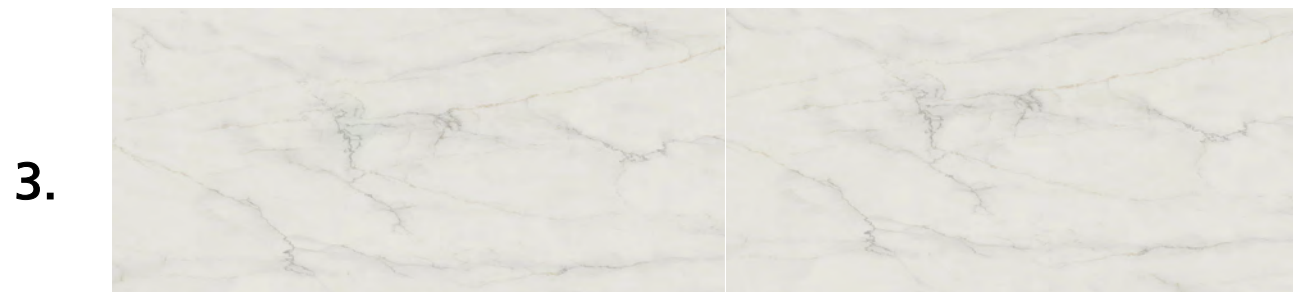

End result

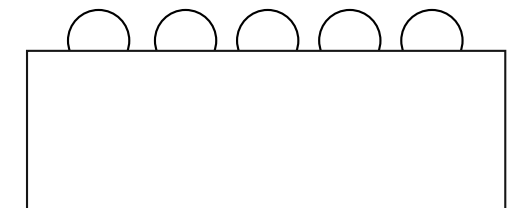

# 501 Snowdrift | End result

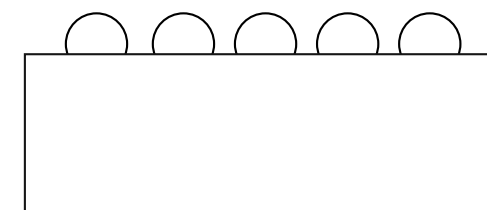
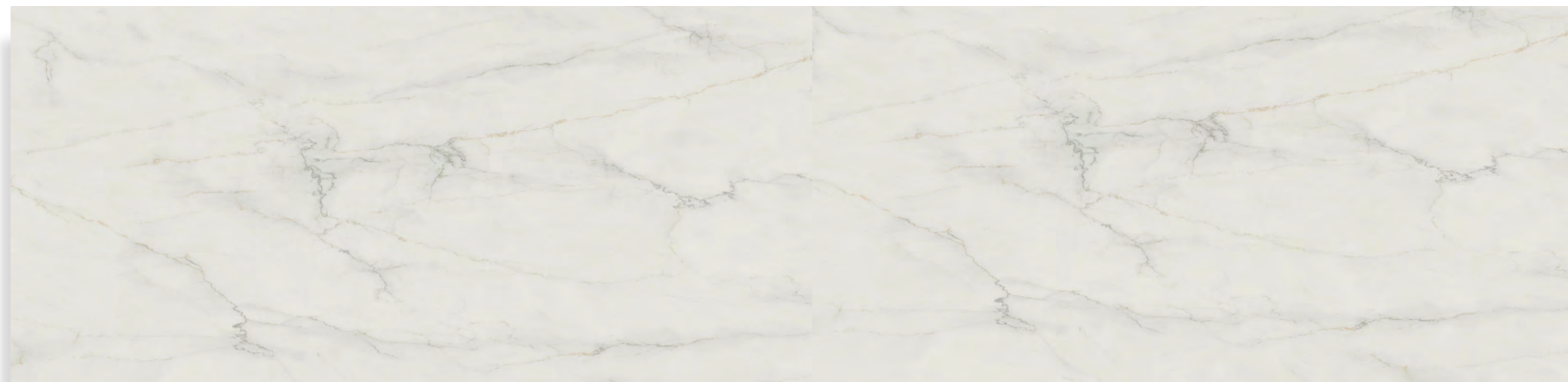

# 501 Snowdrift | Pattern continuity plan

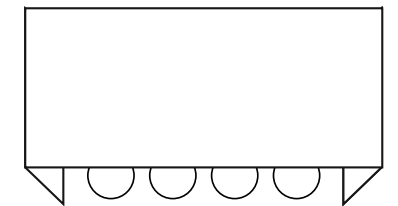
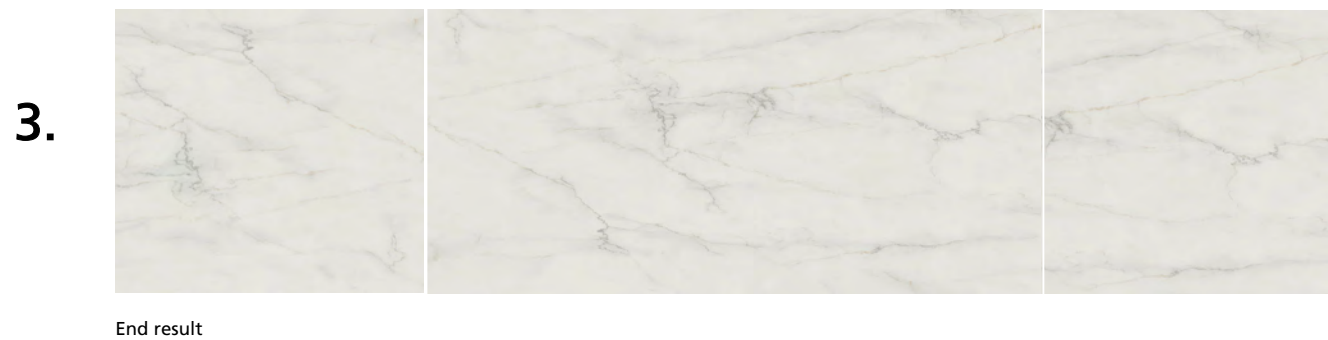
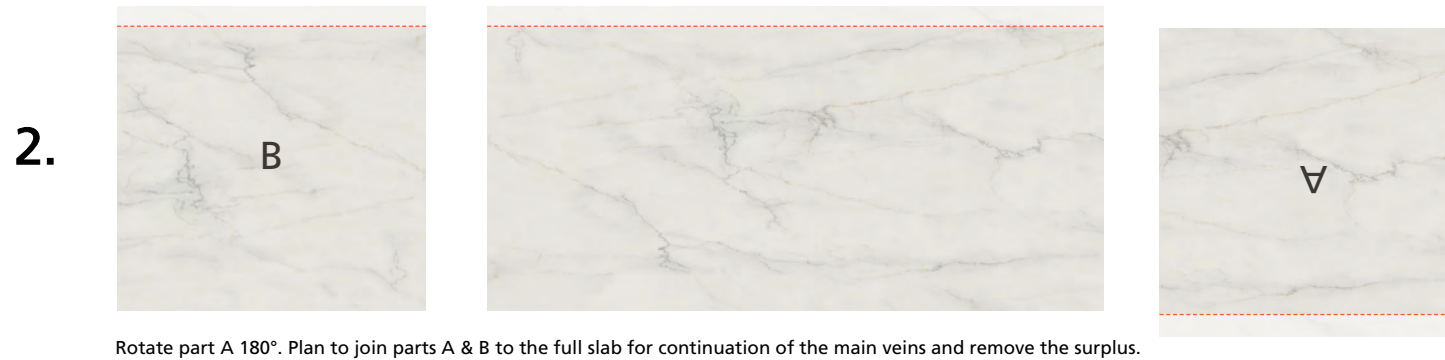

# 501 Snowdrift | End result

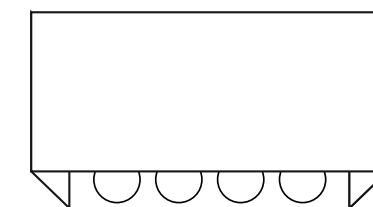
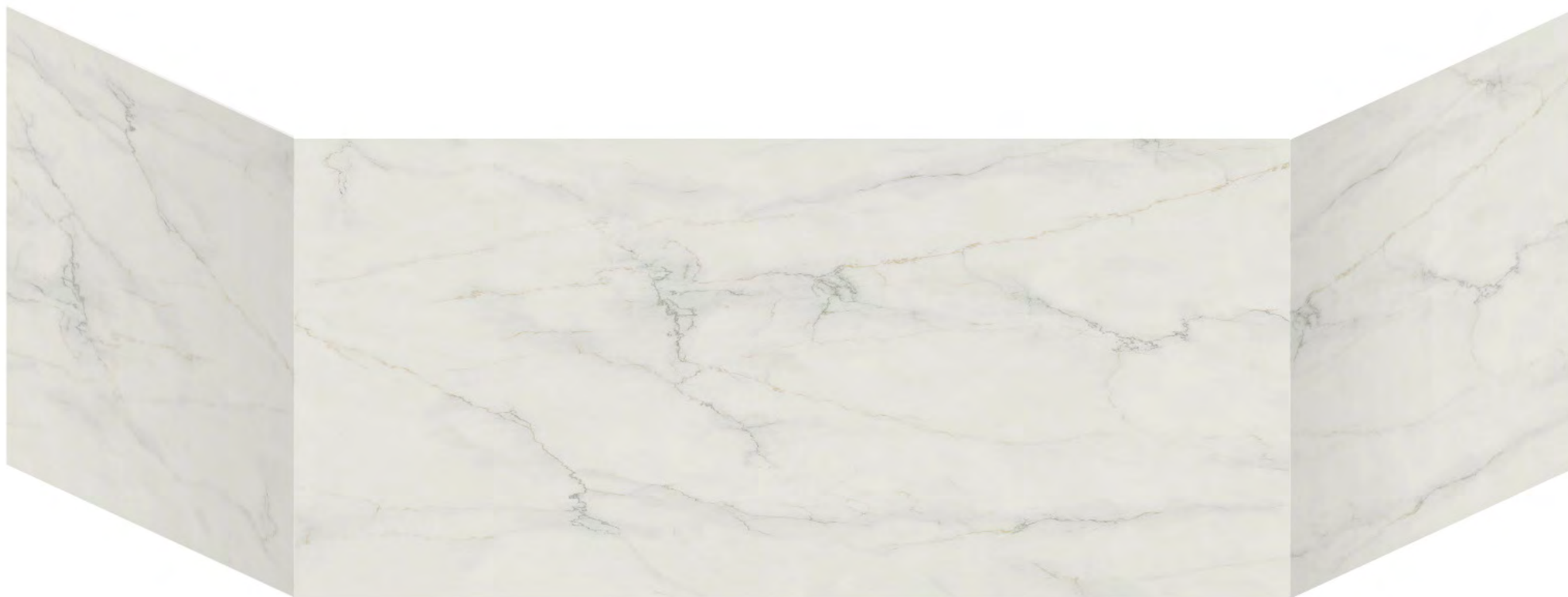

# 501 Snowdrift | Pattern continuity plan

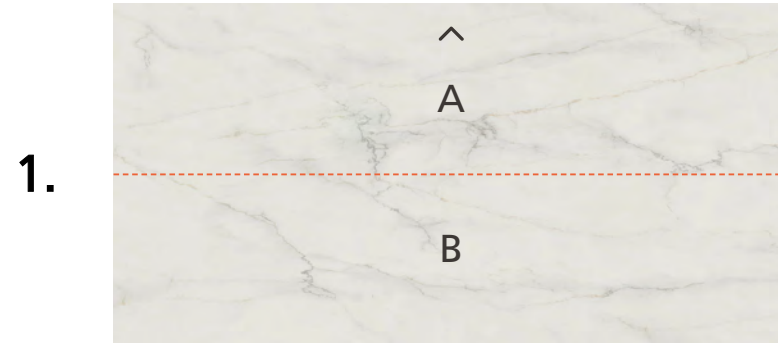

Cut the slab lengthwise



Rotate part B 180°. Plan to join parts A & B for continuation of the main vein and remove the surplus.

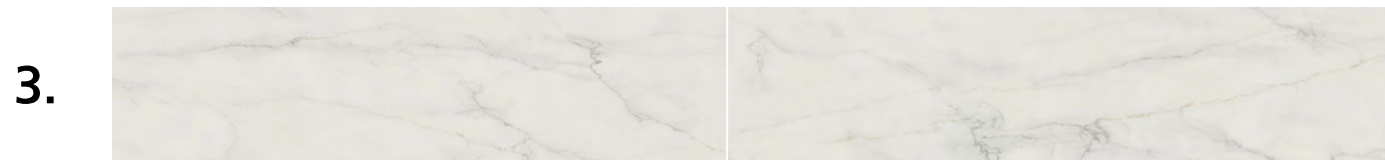

End result

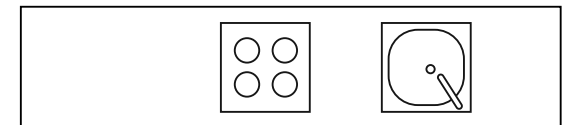

# 501 Snowdrift | End result

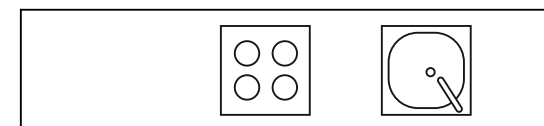
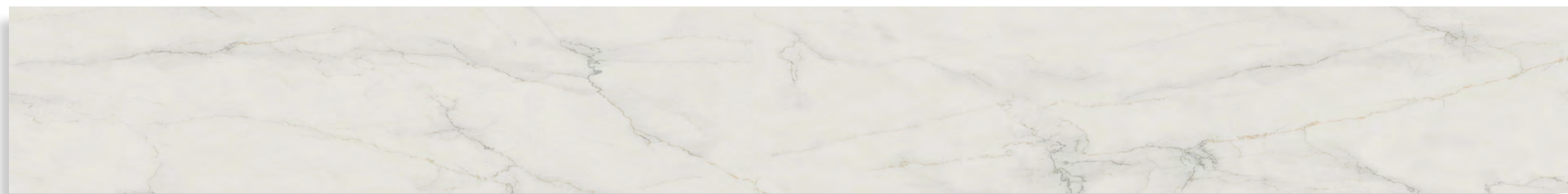

# 501 Snowdrift | Pattern continuity L-shape

1.

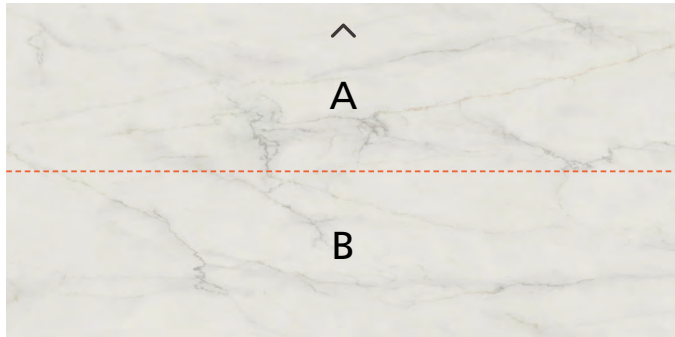

Cut the slab lengthwise

2.

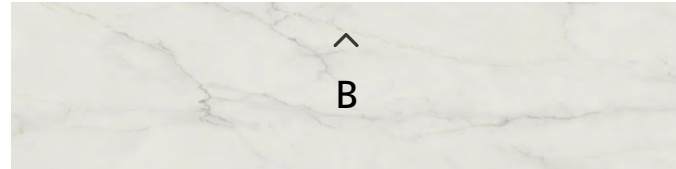

Rotate part A 90° and join parts A & B



3.

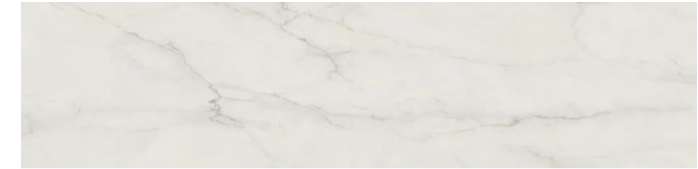

End result

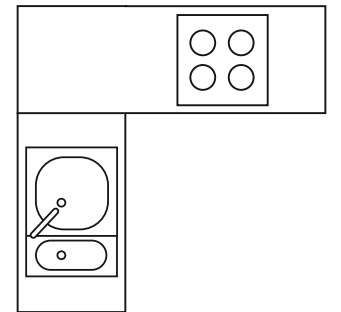
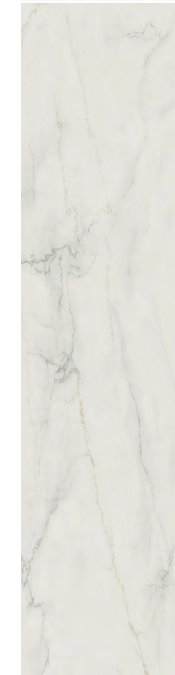

# 501 Snowdrift | End result

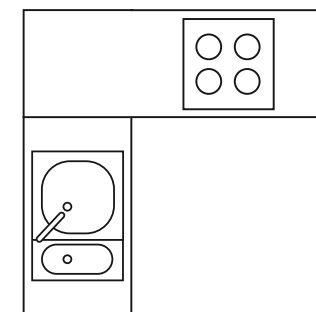
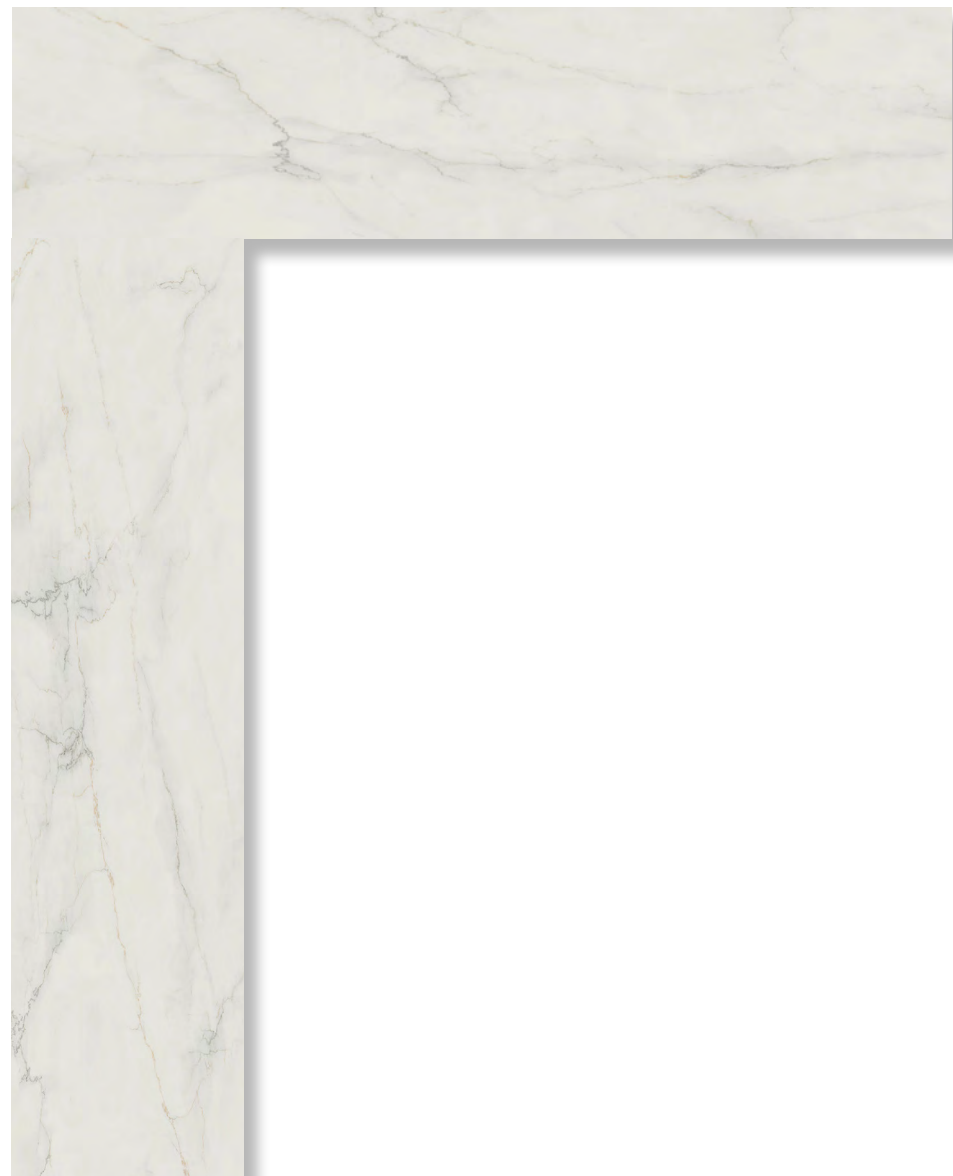

# 501 Snowdrift | Pattern continuity countertop to backsplash

1.

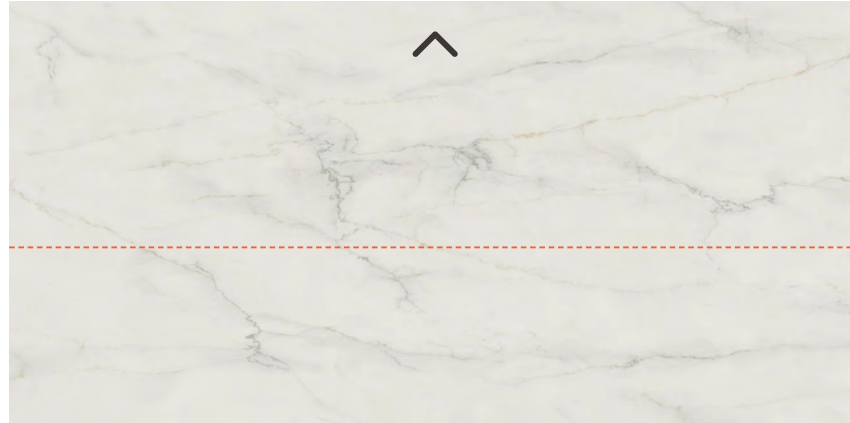

Cut the slab lengthwise

2.

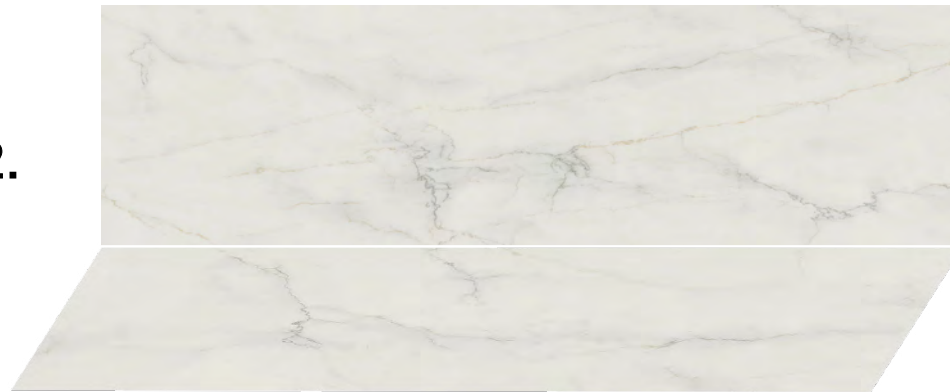

End result



# 501 Snowdrift | End result

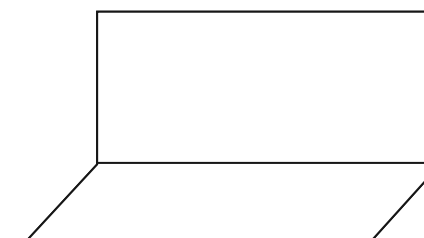

# 502 Sleet | Releasing slab tension

Full Slab

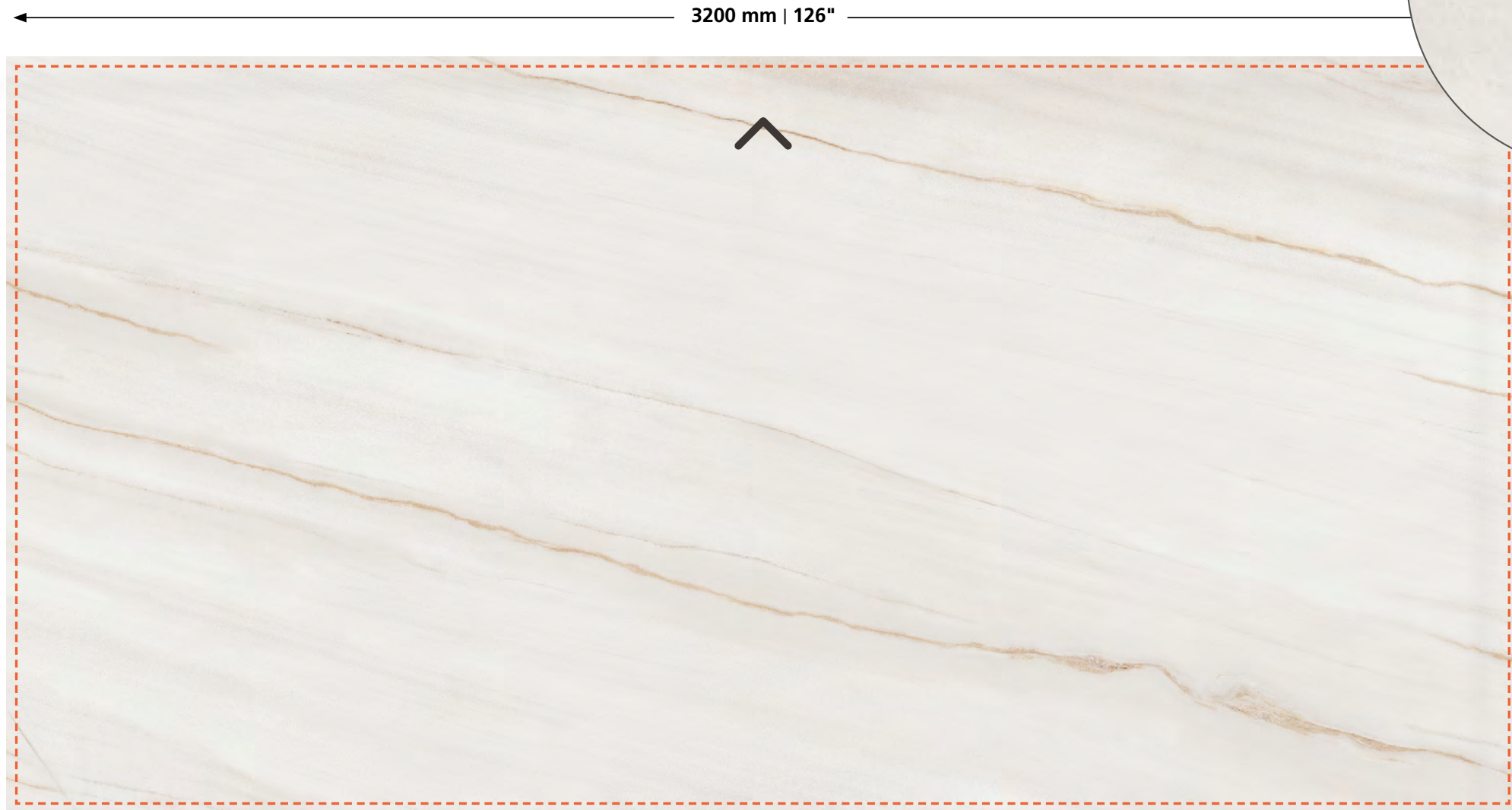

Reduce the 4 sides of the perimeter at a distance of 20-30 mm from the edges to release tension.

The useable slab size after releasing tension is 3160/3140 mm X 1560/1540 mm. (124<sup>3</sup>/<sub>8</sub>"/123<sup>5</sup>/<sub>8</sub>" X 61<sup>1</sup>/<sub>2</sub>"/60<sup>5</sup>/<sub>8</sub>" )

# 502 Sleet | Pattern continuity plan

1.



Rotate one slab 180°

2.



Plan to join the two slabs for continuation of the main veins and remove the surplus

3.

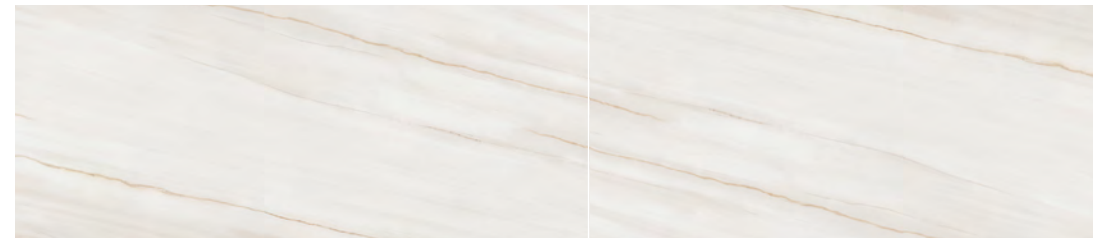

End result

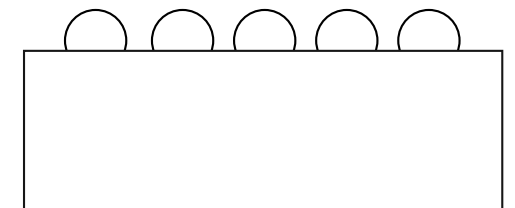

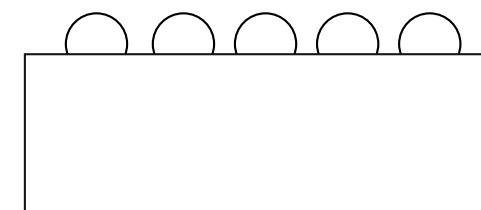
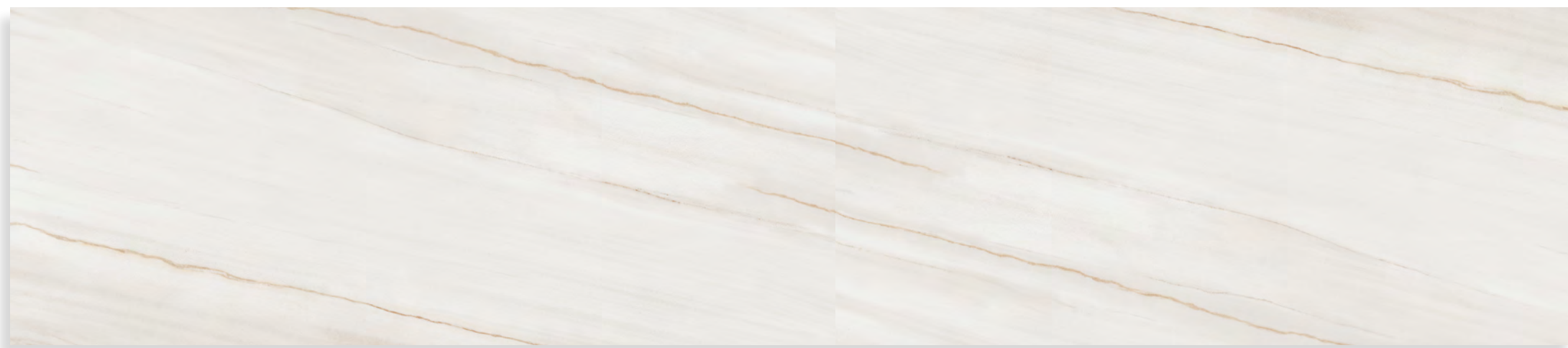

# 502 Sleet | Pattern continuity plan

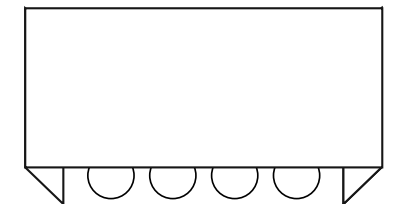
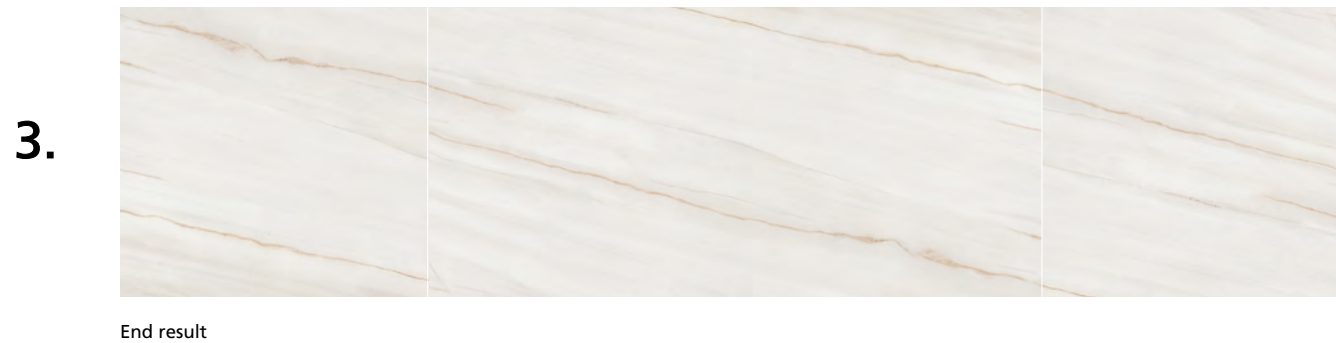
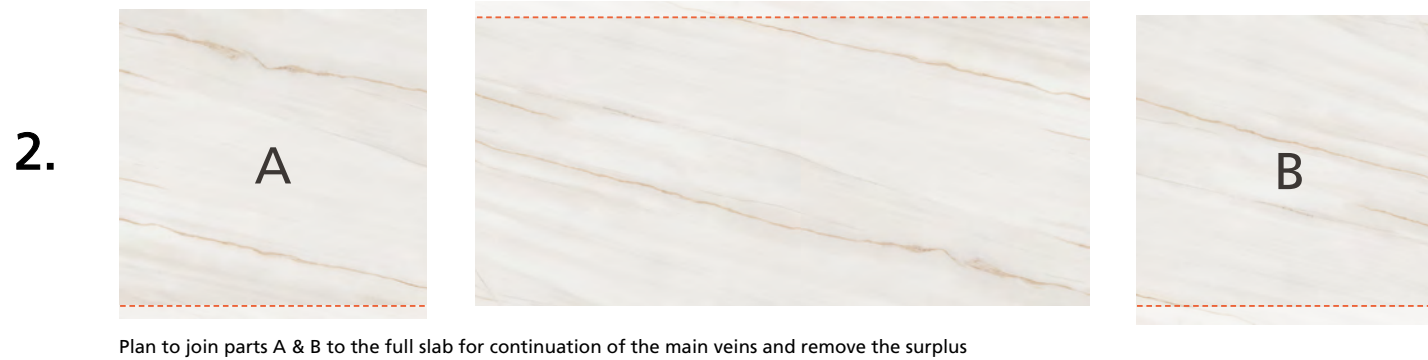

502 Sleet | End result

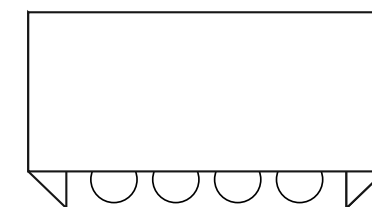

# 502 Sleet | Pattern continuity plan

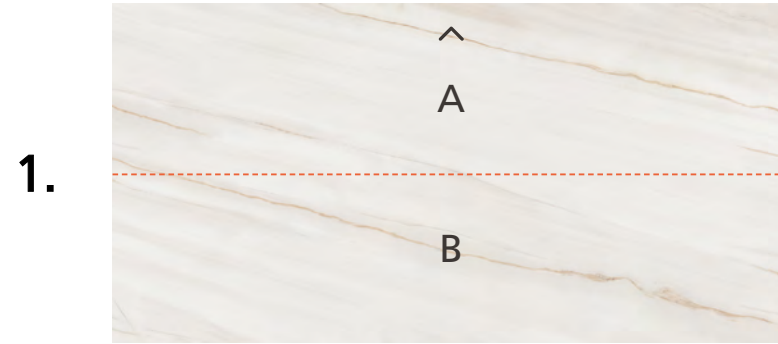

Cut the slab lengthwise

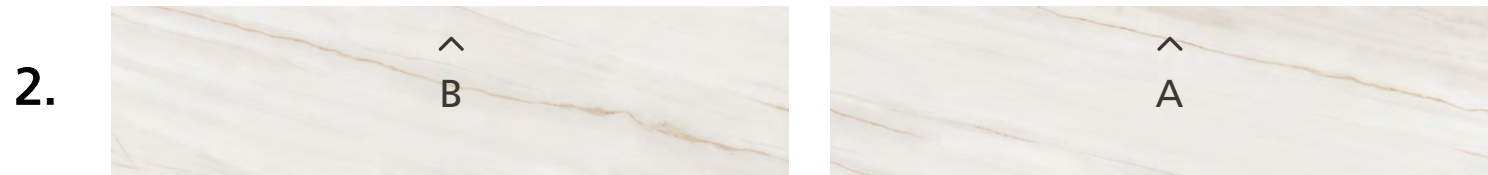

Join parts A & B

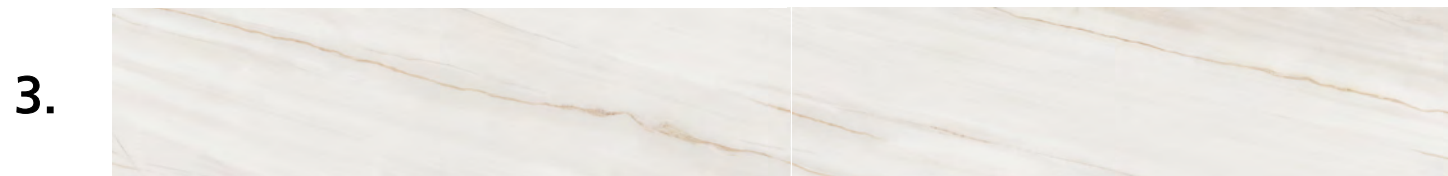

End result

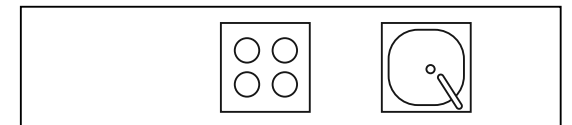

502 Sleet | End result

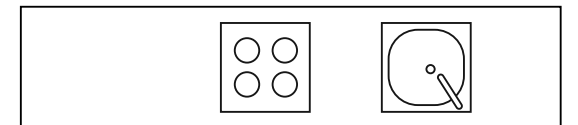
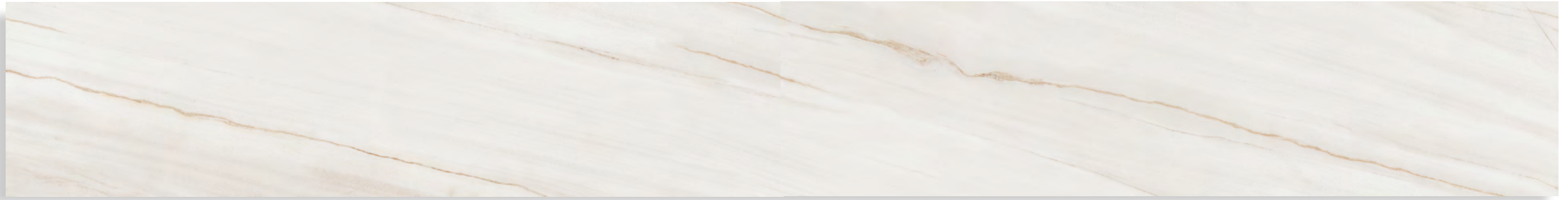

# 502 Sleet | Pattern continuity L-shape

1.

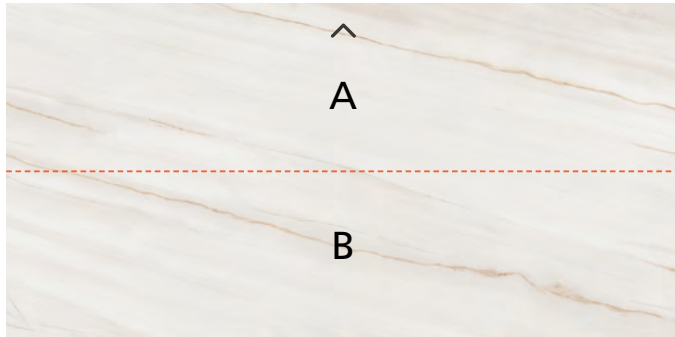

Cut the slab lengthwise

2.

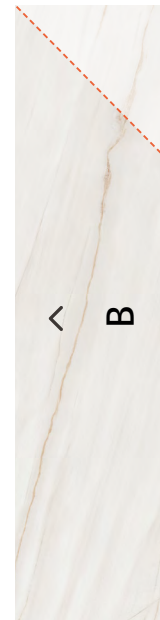
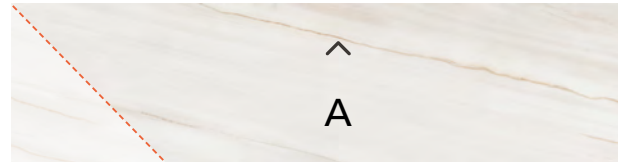

Rotate part B (90°). Plan to join parts A & B for pattern continuity and remove the surplus.

3.

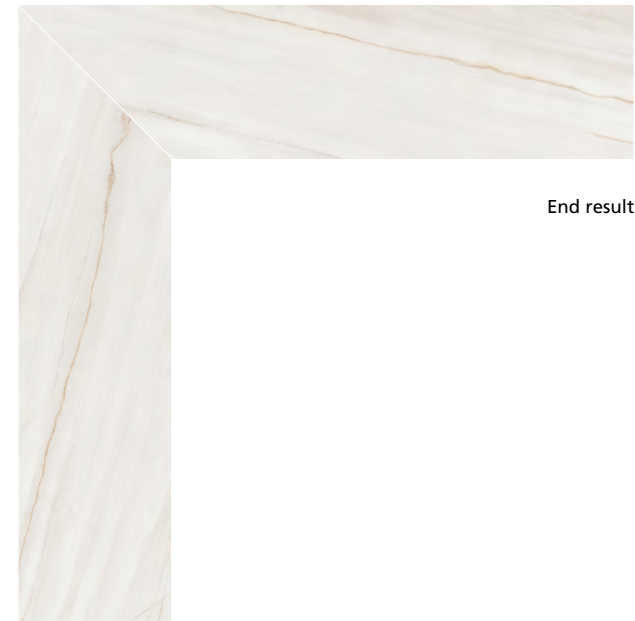

End result

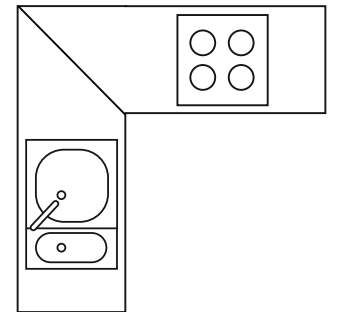

502 Sleet | End result

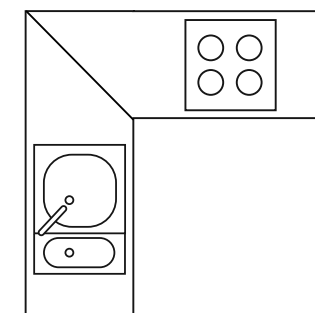

# 502 Sleet | Pattern continuity countertop to backsplash

1.



Cut the slab lengthwise

2.

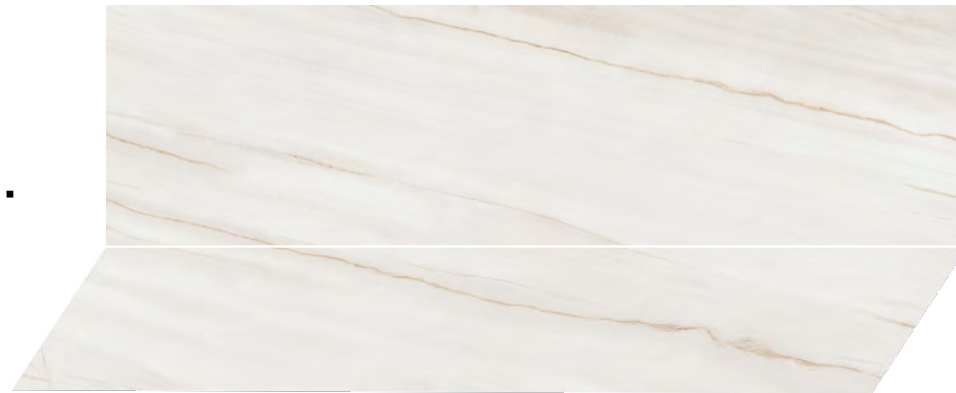

End result



# 502 Sleet | End result

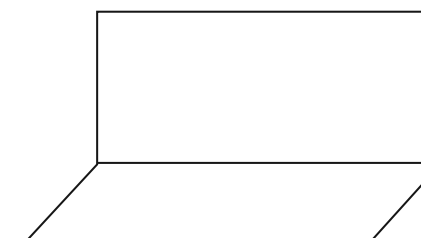
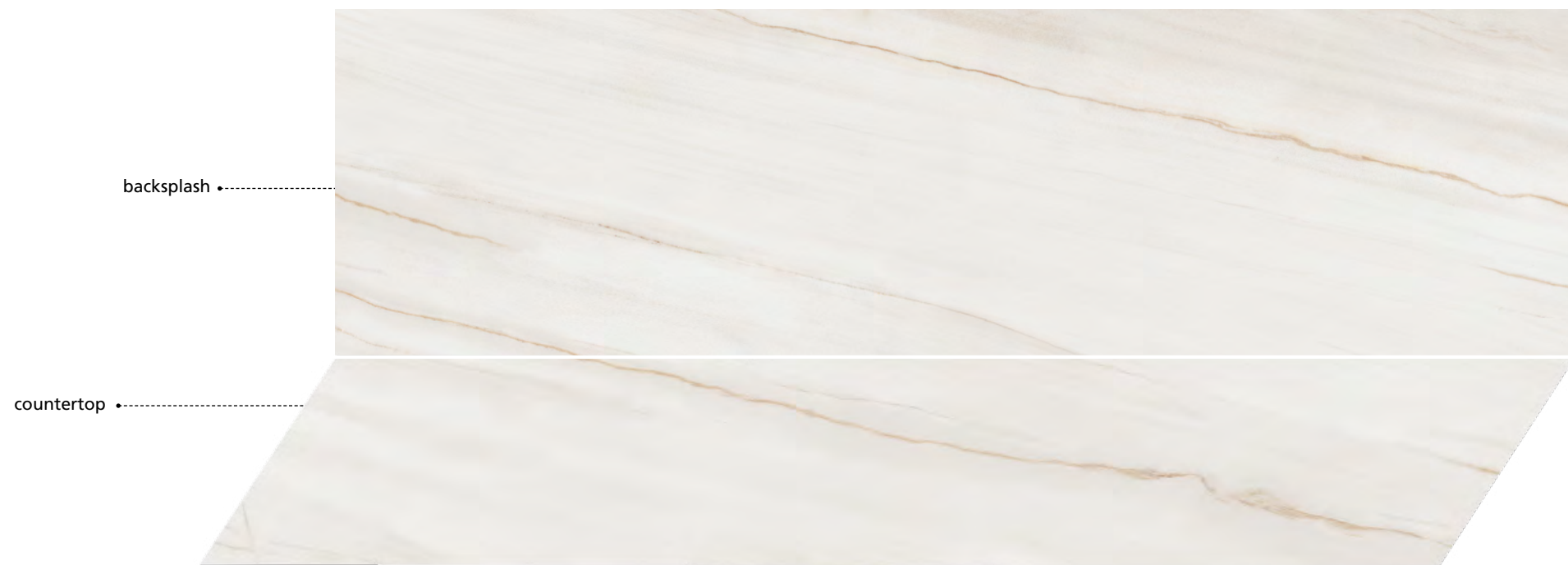

# 503 Circa | Releasing slab tension

Full Slab

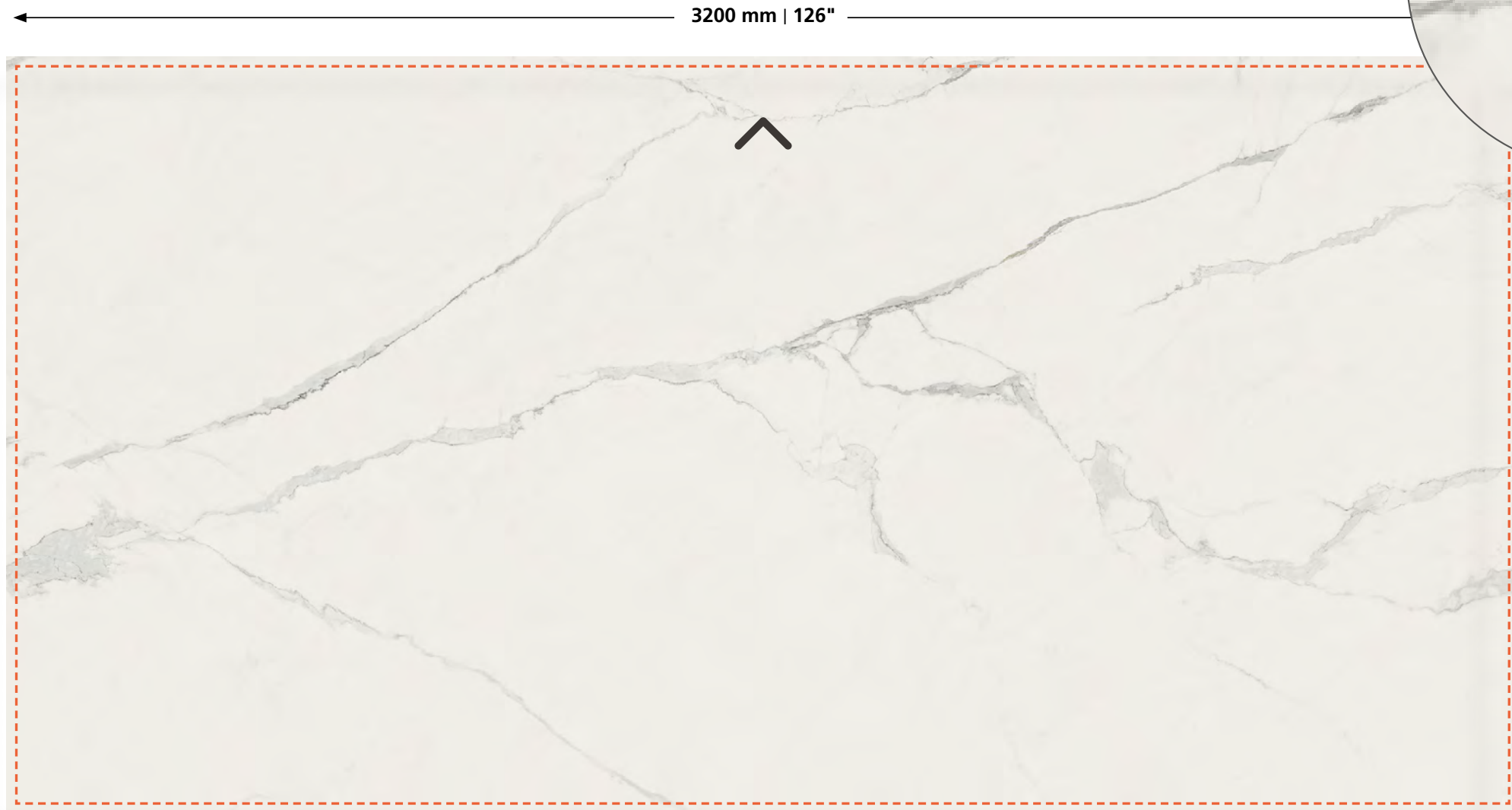

Reduce the 4 sides of the perimeter at a distance of 20-30 mm from the edges to release tension.

The useable slab size after releasing tension is 3160/3140 mm X 1560/1540 mm. (124<sup>3</sup>/<sub>8</sub>"/123<sup>5</sup>/<sub>8</sub>" X 61<sup>1</sup>/<sub>2</sub>"/60<sup>5</sup>/<sub>8</sub>" )

# 503 Circa | Pattern continuity plan



Plan to join the two slabs for continuation of the main veins and remove the surplus



End result

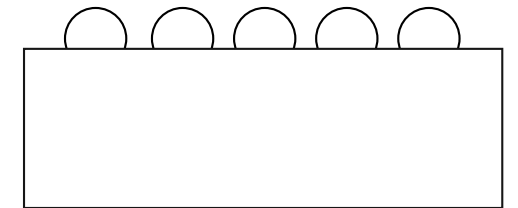

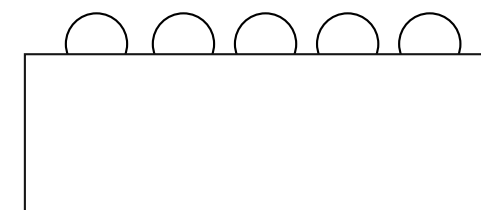
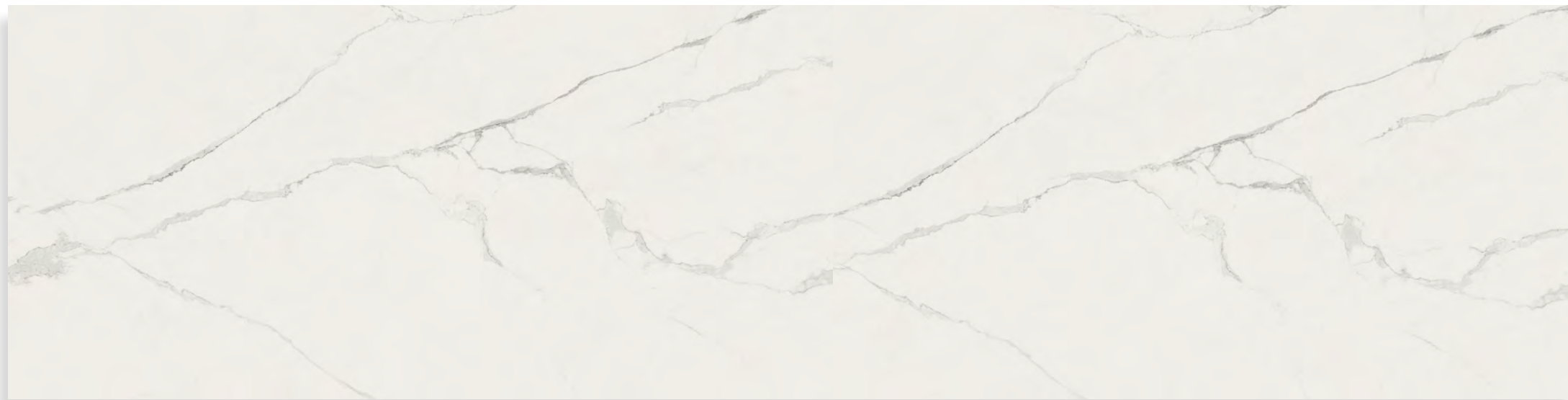

# 503 Circa | Pattern continuity short edge

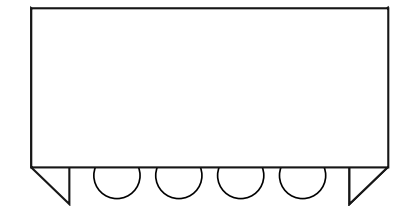
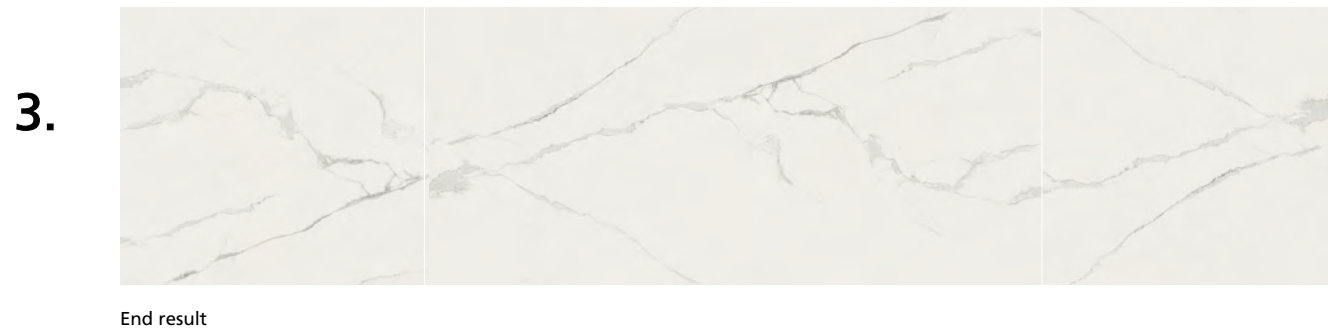

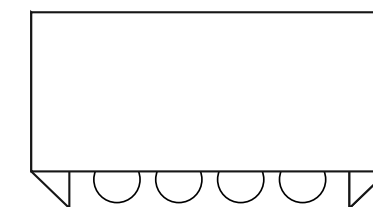
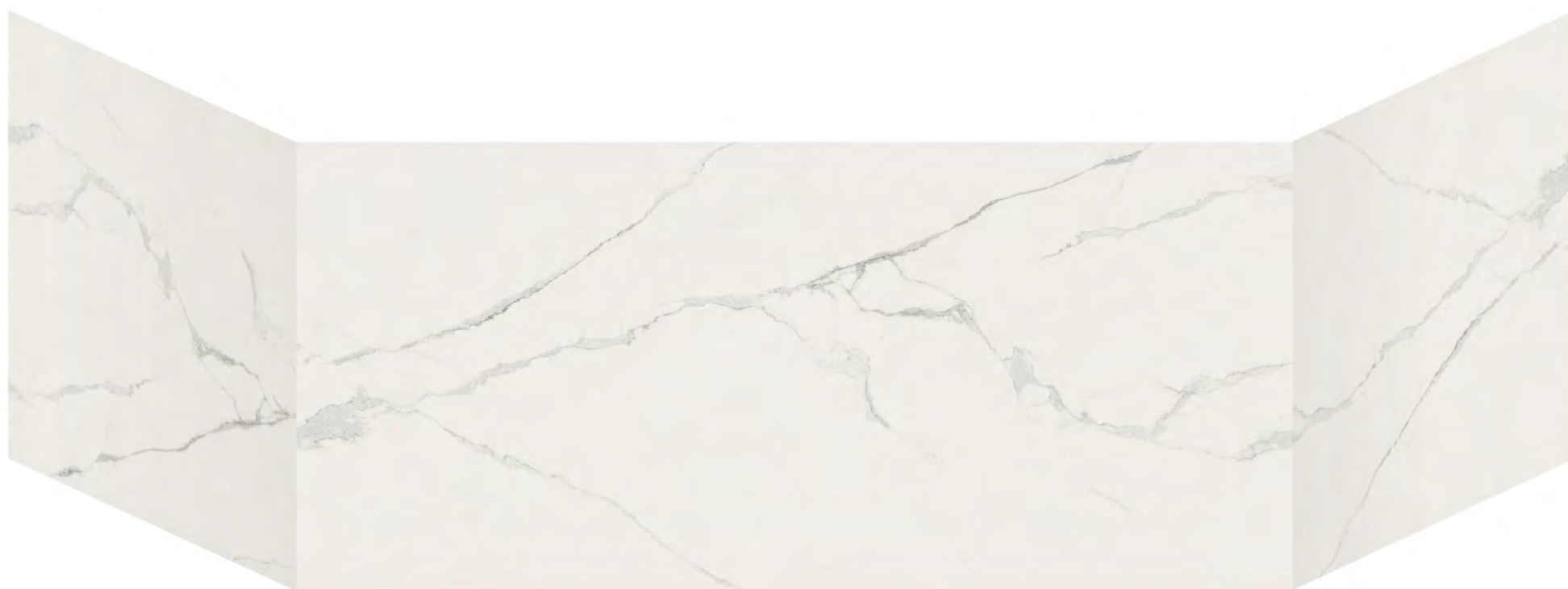

# 503 Circa | Pattern continuity plan



Cut the slab lengthwise

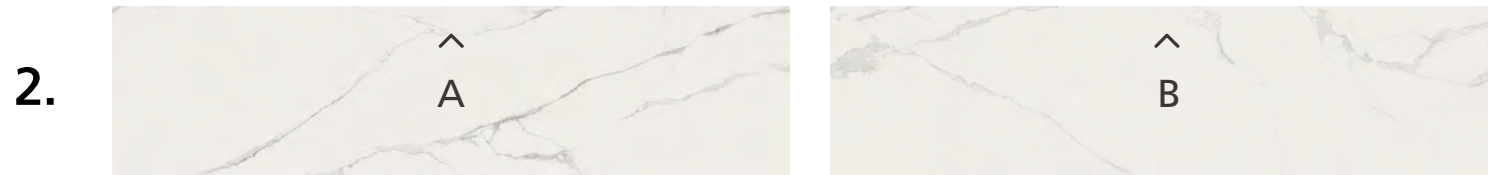

Join parts A & B

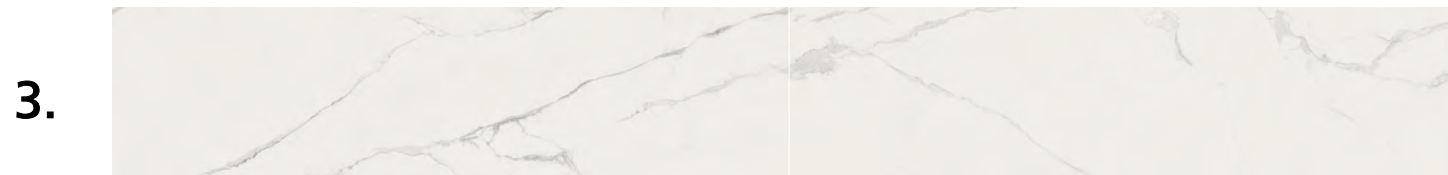

End result

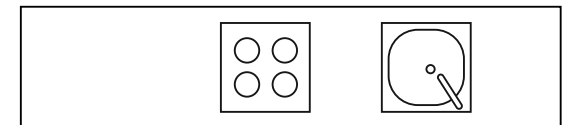

503 Circa | End result

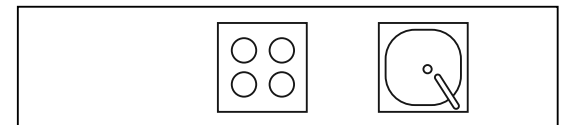
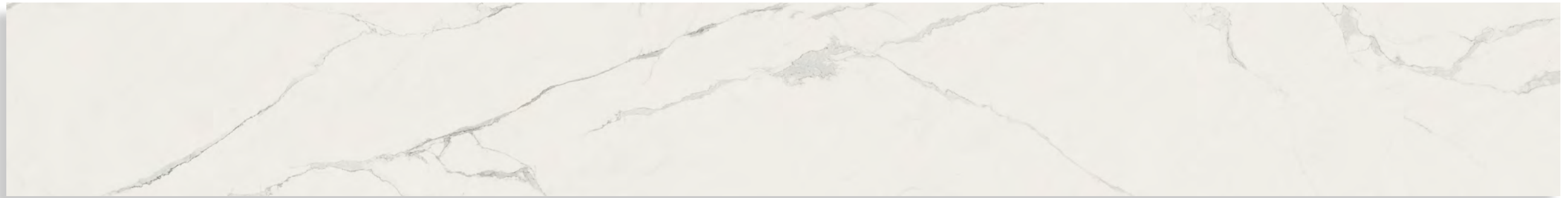

# 503 Circa | Pattern continuity L-shape

1.

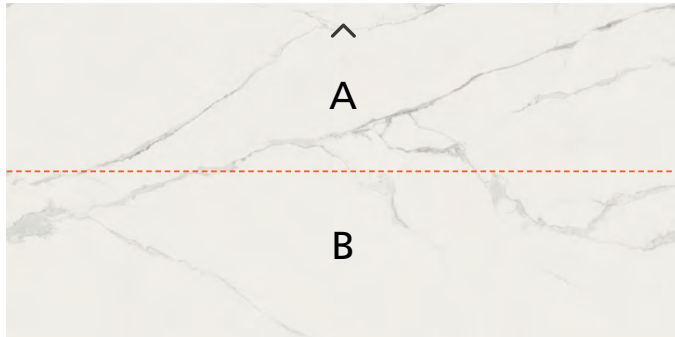

Cut the slab lengthwise

2.

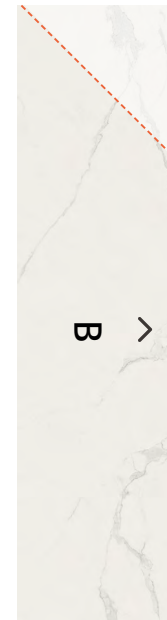

Rotate part A 180° and part B 90°. Plan to join parts A & B and remove the surplus.

3.

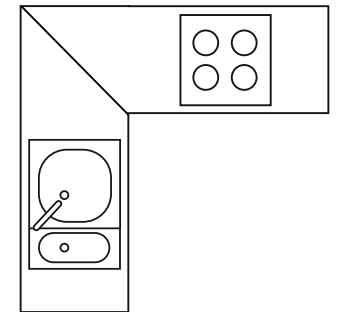
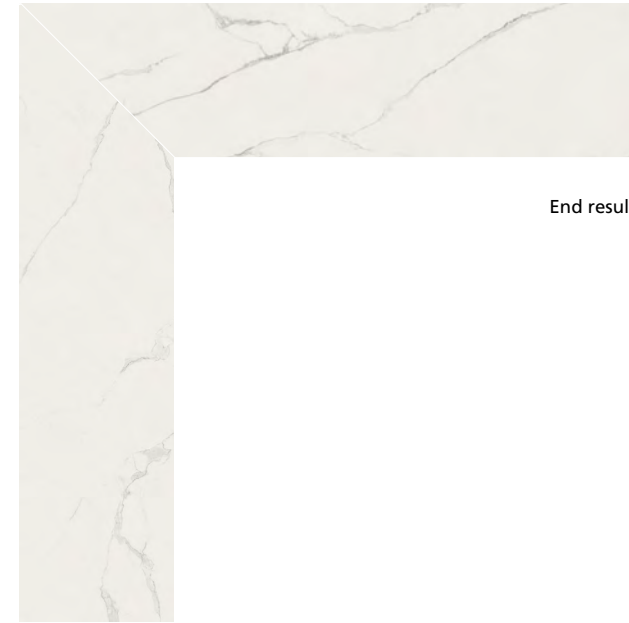

503 Circa | End result

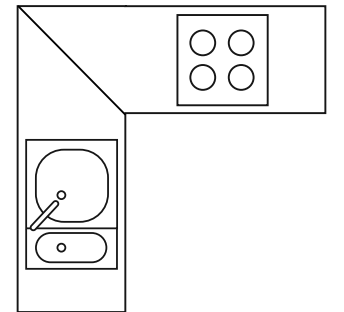
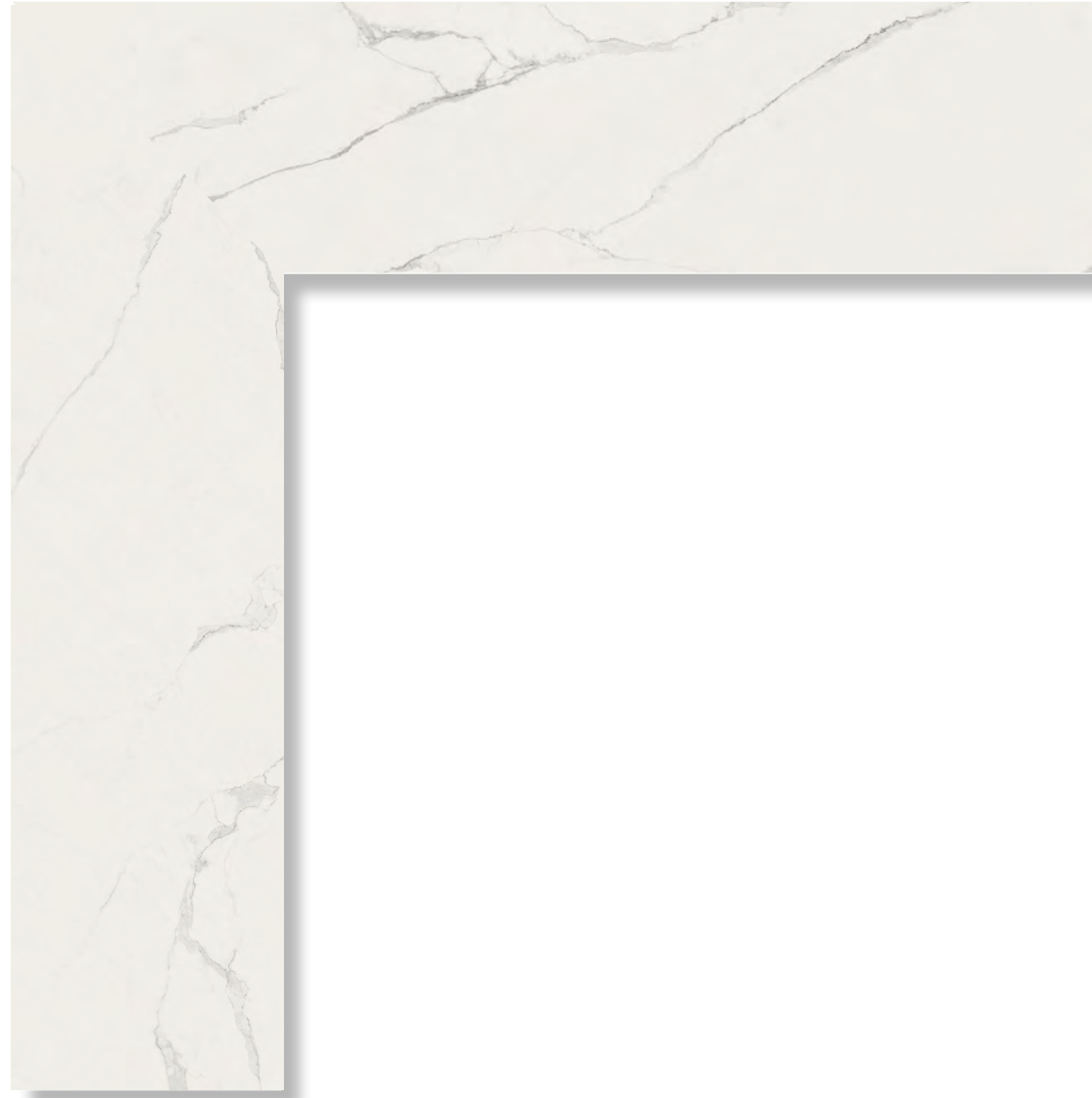

503 Circa | Pattern continuity countertop to backsplash

1.

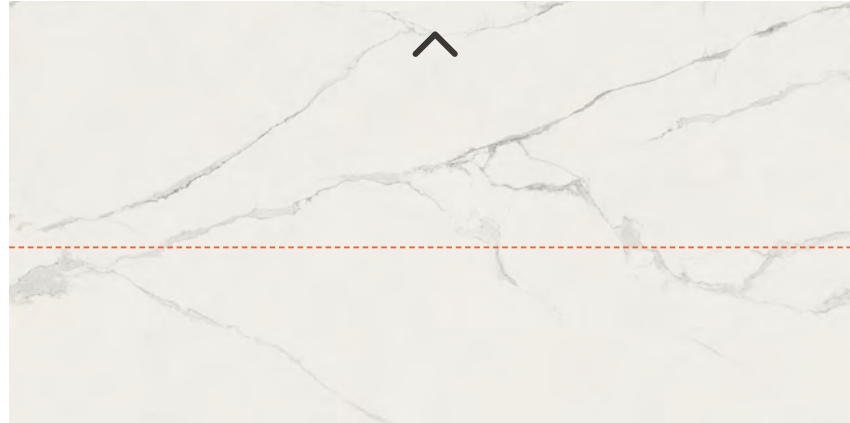

Cut the slab lengthwise

2.

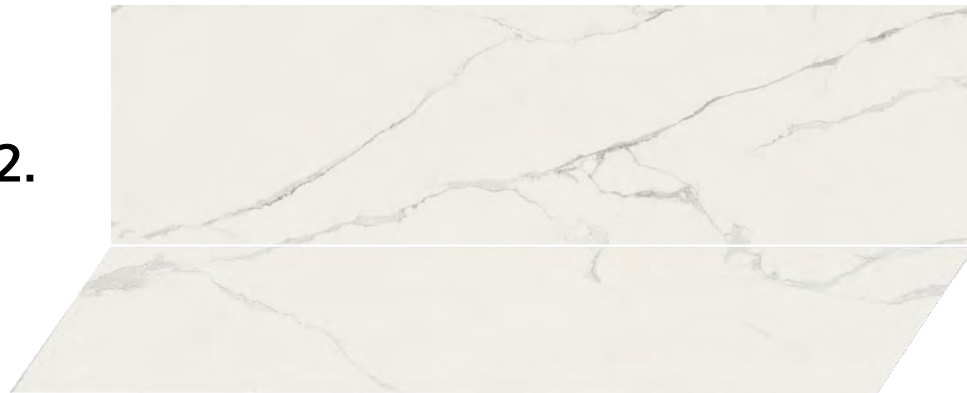

End result



# 503 Circa | End result

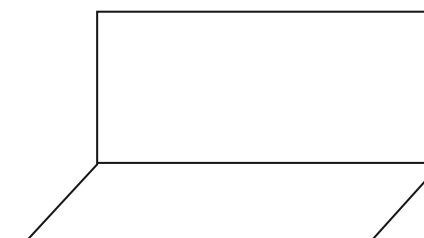
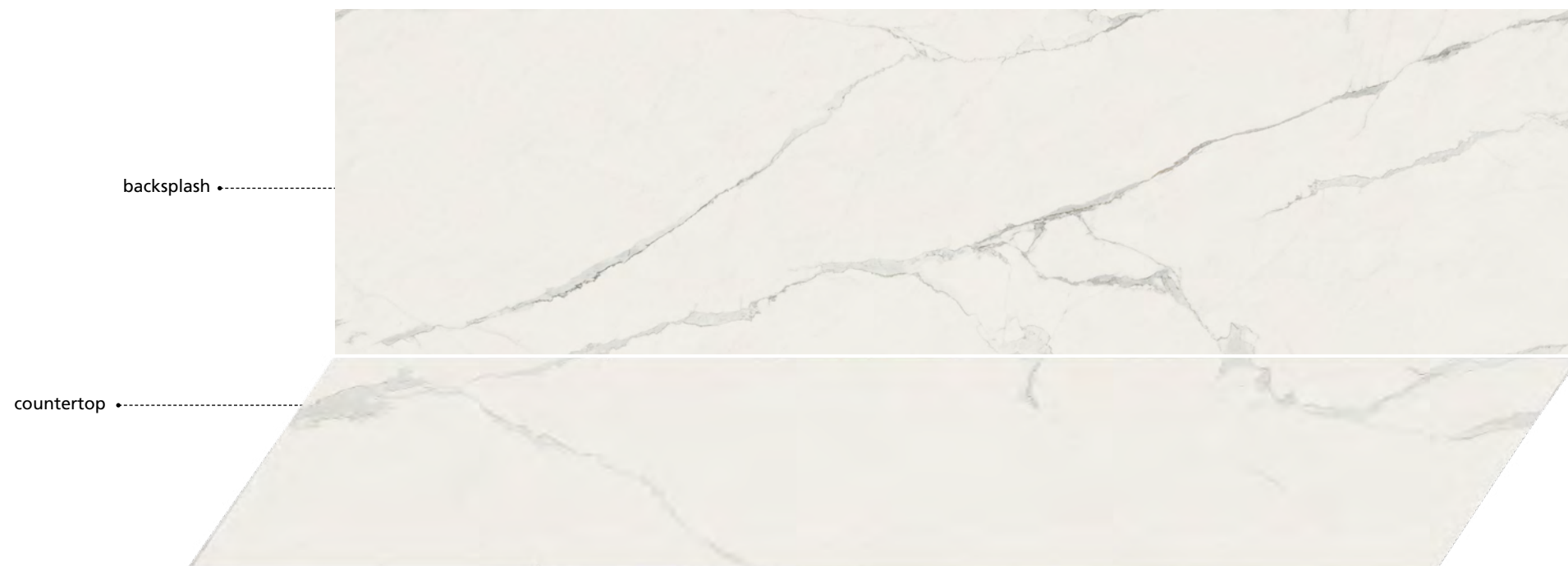

# 504 Lumena | Releasing slab tension

Full Slab

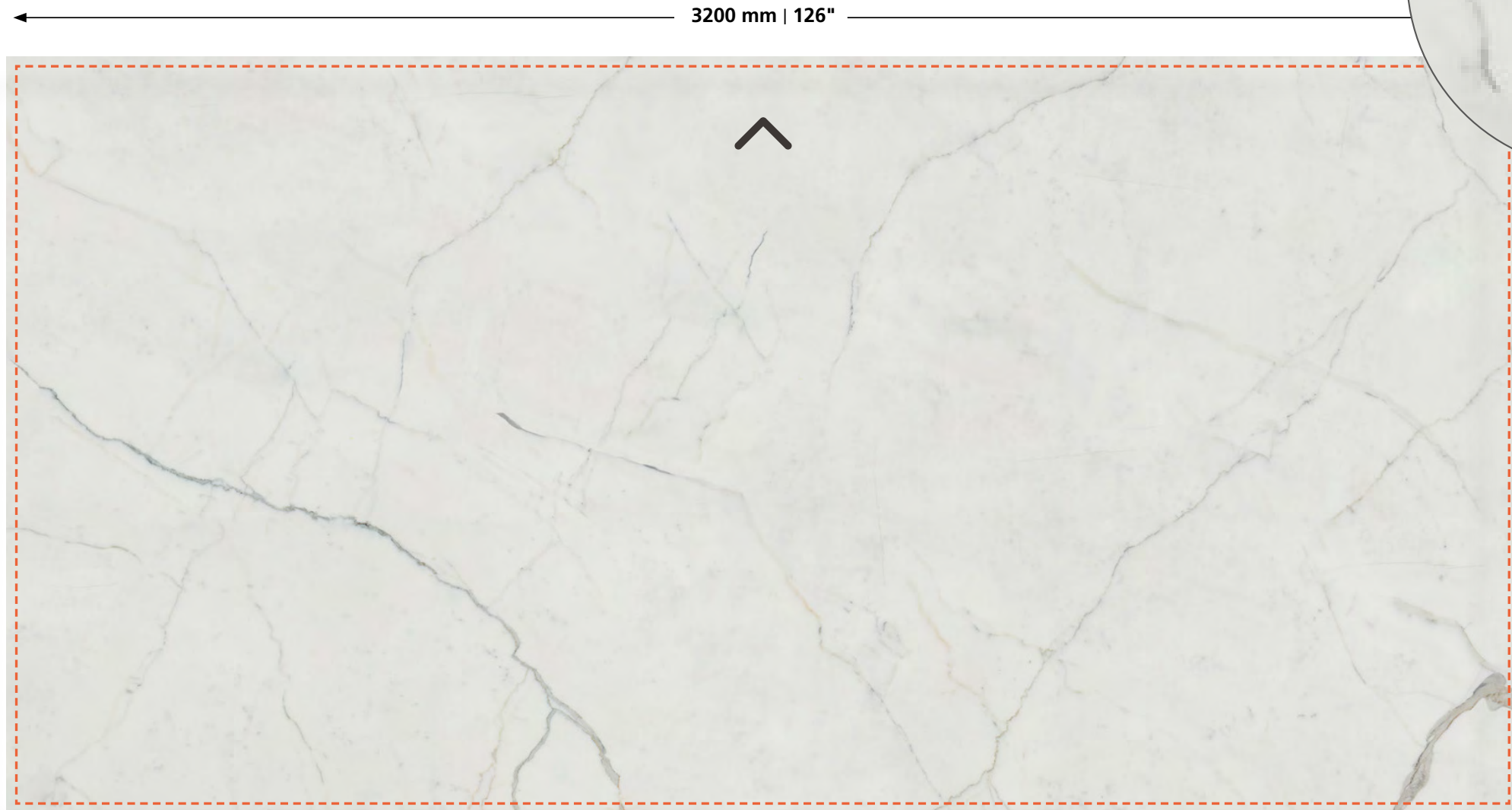

20-30 mm

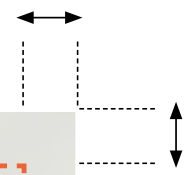

Reduce the 4 sides of the perimeter at a distance of 20-30 mm from the edges to release tension.

The useable slab size after releasing tension is 3160/3140 mm X 1560/1540 mm. (124<sup>3</sup>/<sub>8</sub>"/123<sup>5</sup>/<sub>8</sub>" X 61<sup>1</sup>/<sub>2</sub>"/60<sup>5</sup>/<sub>8</sub>" )

1600 mm | 63"

# 504 Lumena | Pattern continuity plan



Rotate one slab 180°

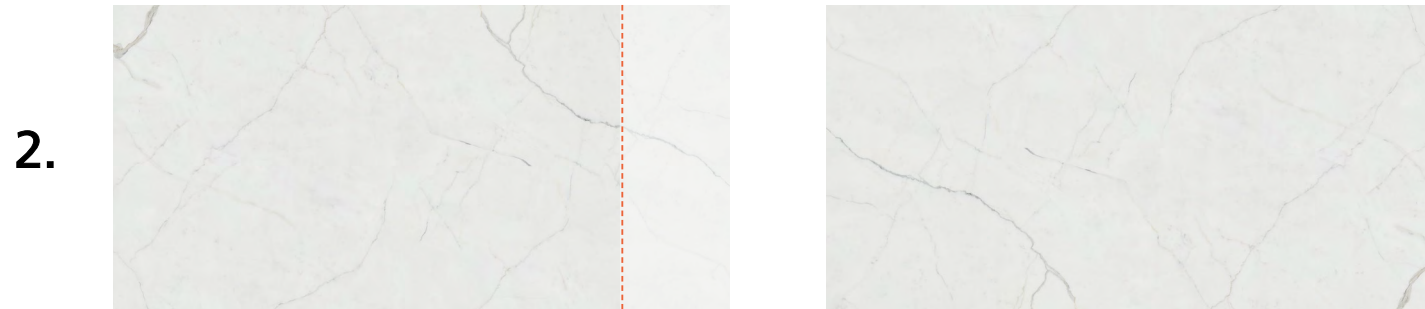

Plan to join the two slabs for continuation of the main vein and remove the surplus

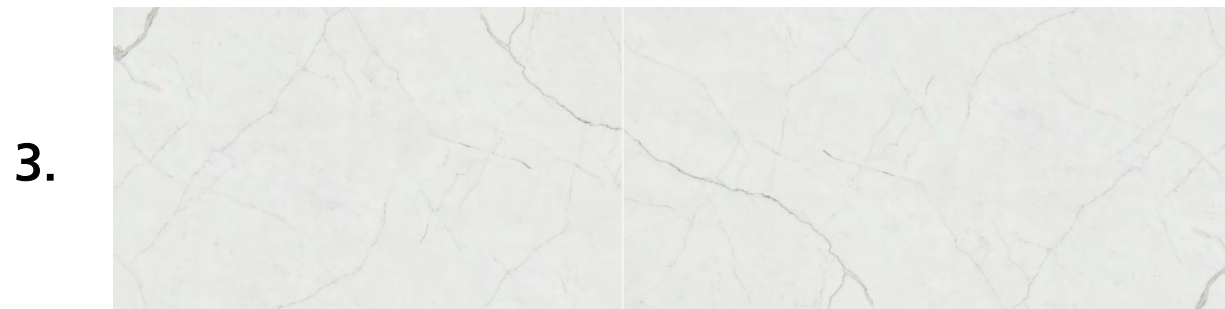

End result

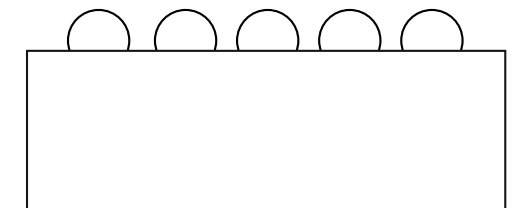

504 Lumena | End result

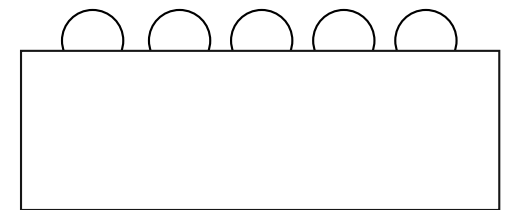

# 504 Lumena | Pattern continuity plan

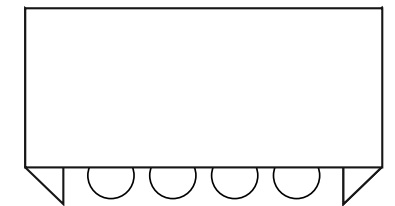
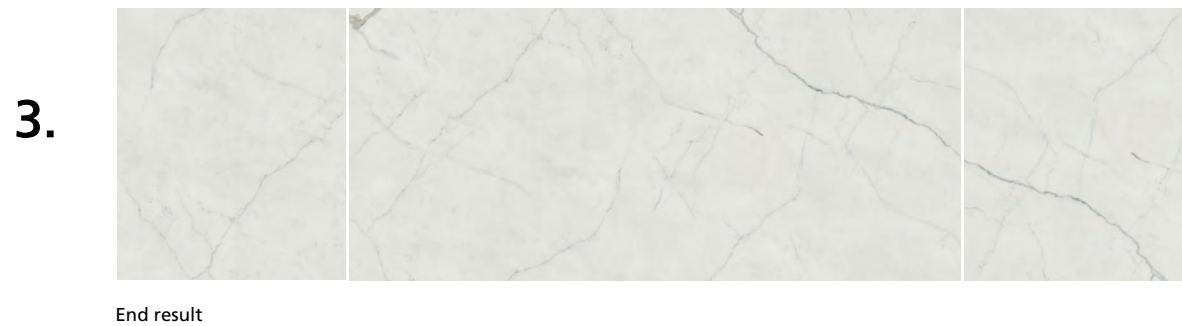

504 Lumena | End result

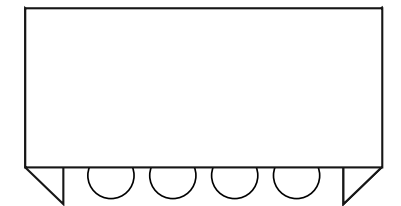
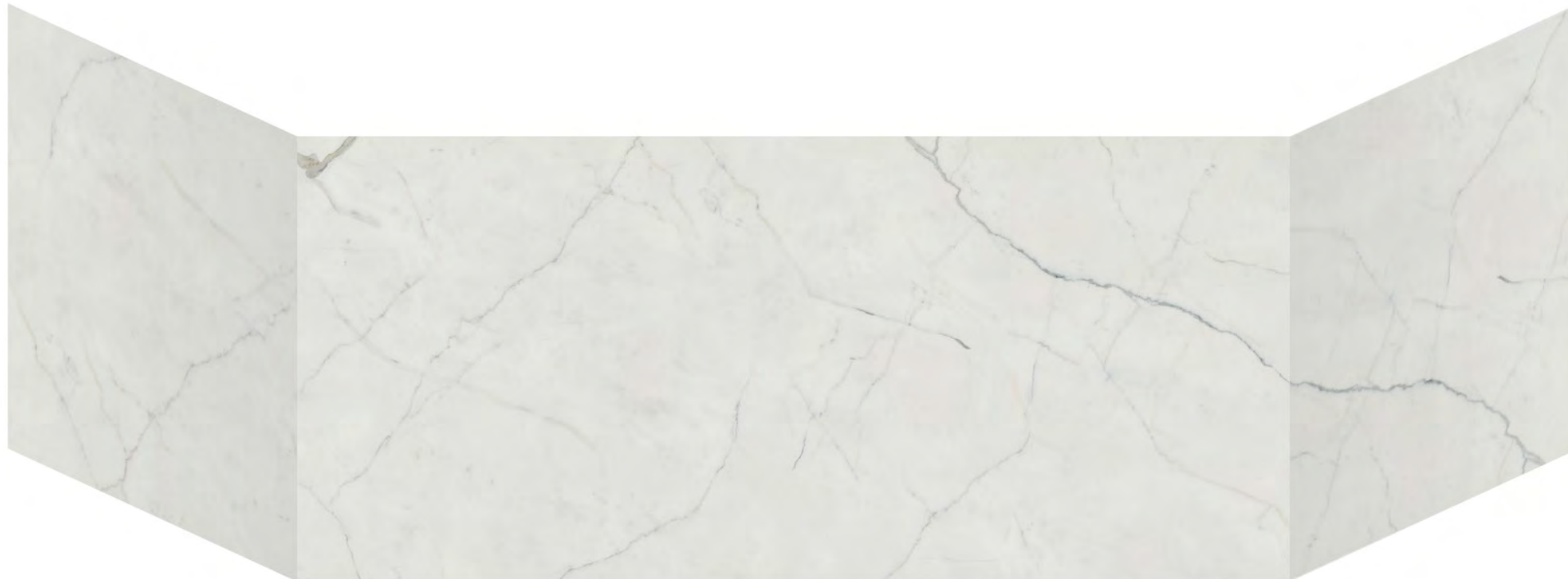

# 504 Lumena | Pattern continuity plan

1.

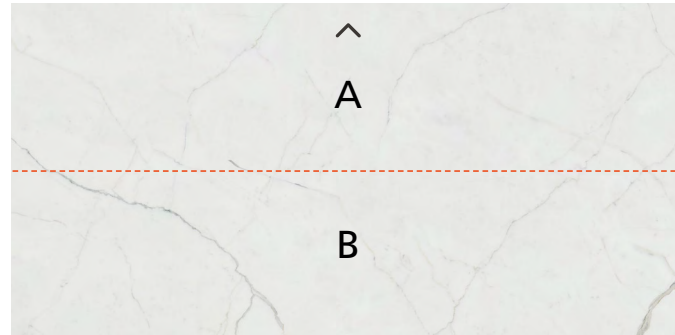

Cut the slab lengthwise

2.

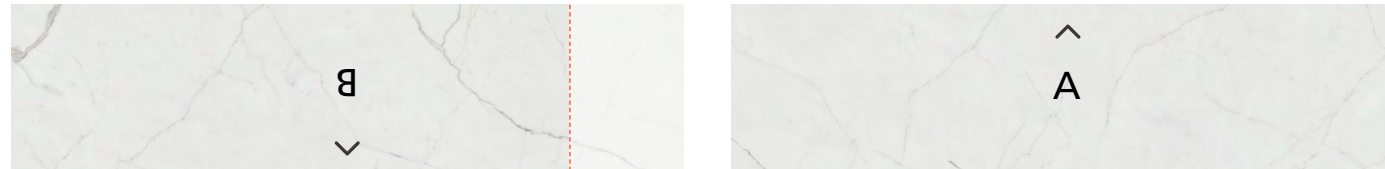

Rotate part B 180°. Plan to join parts A & B for continuation of the main vein and remove the surplus.

3.

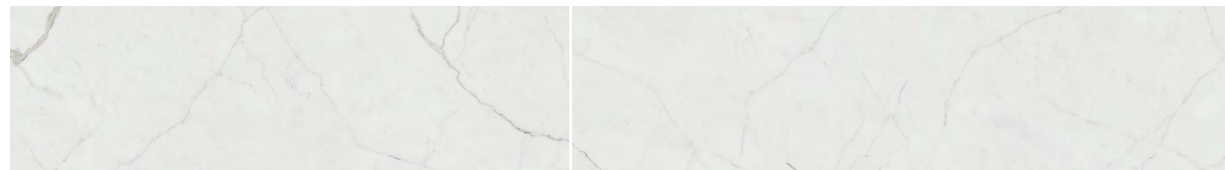

End result

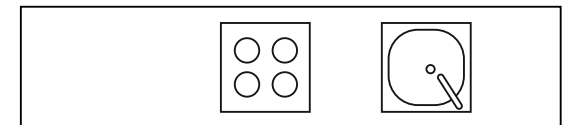

## 504 Lumena | End result

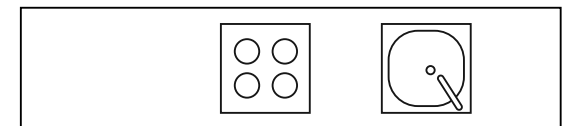
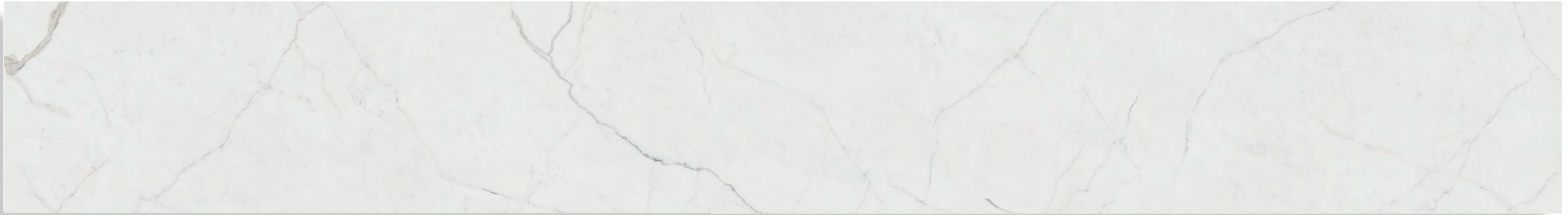

# 504 Lumena | Pattern continuity L-shape

1.

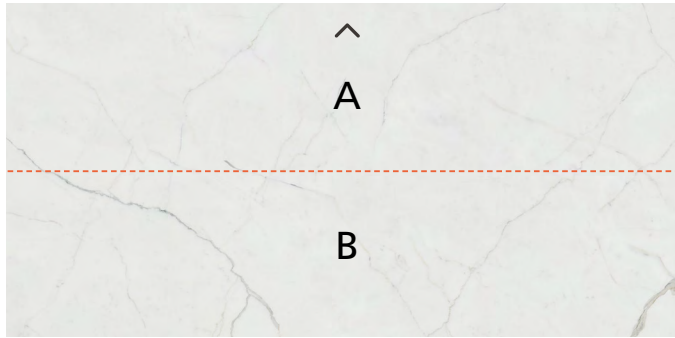

Cut the slab lengthwise

2.

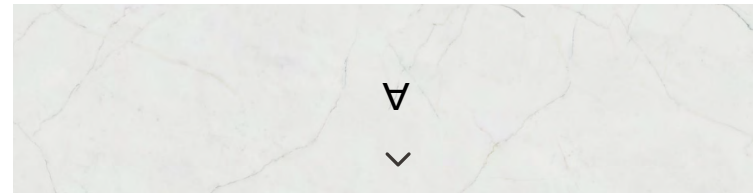

Rotate part A 180° and part B 90°. Plan to join parts A & B for continuation of the main vein and remove the surplus.

3.

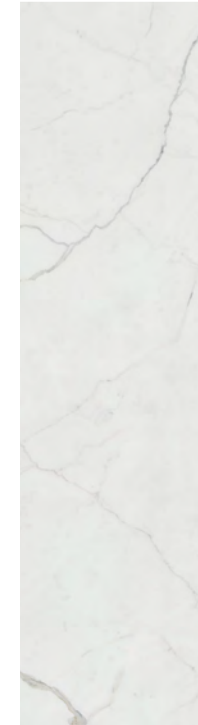
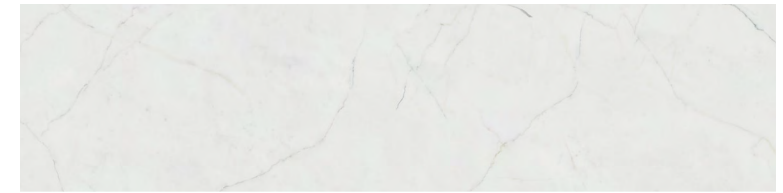

End result

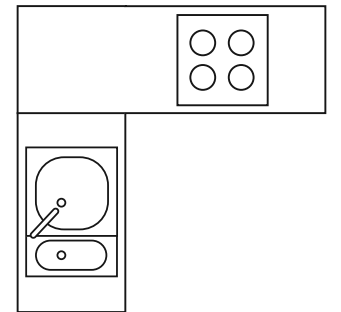

504 Lumena | End result

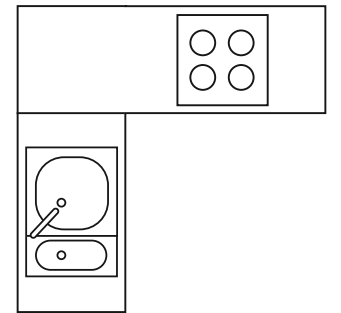
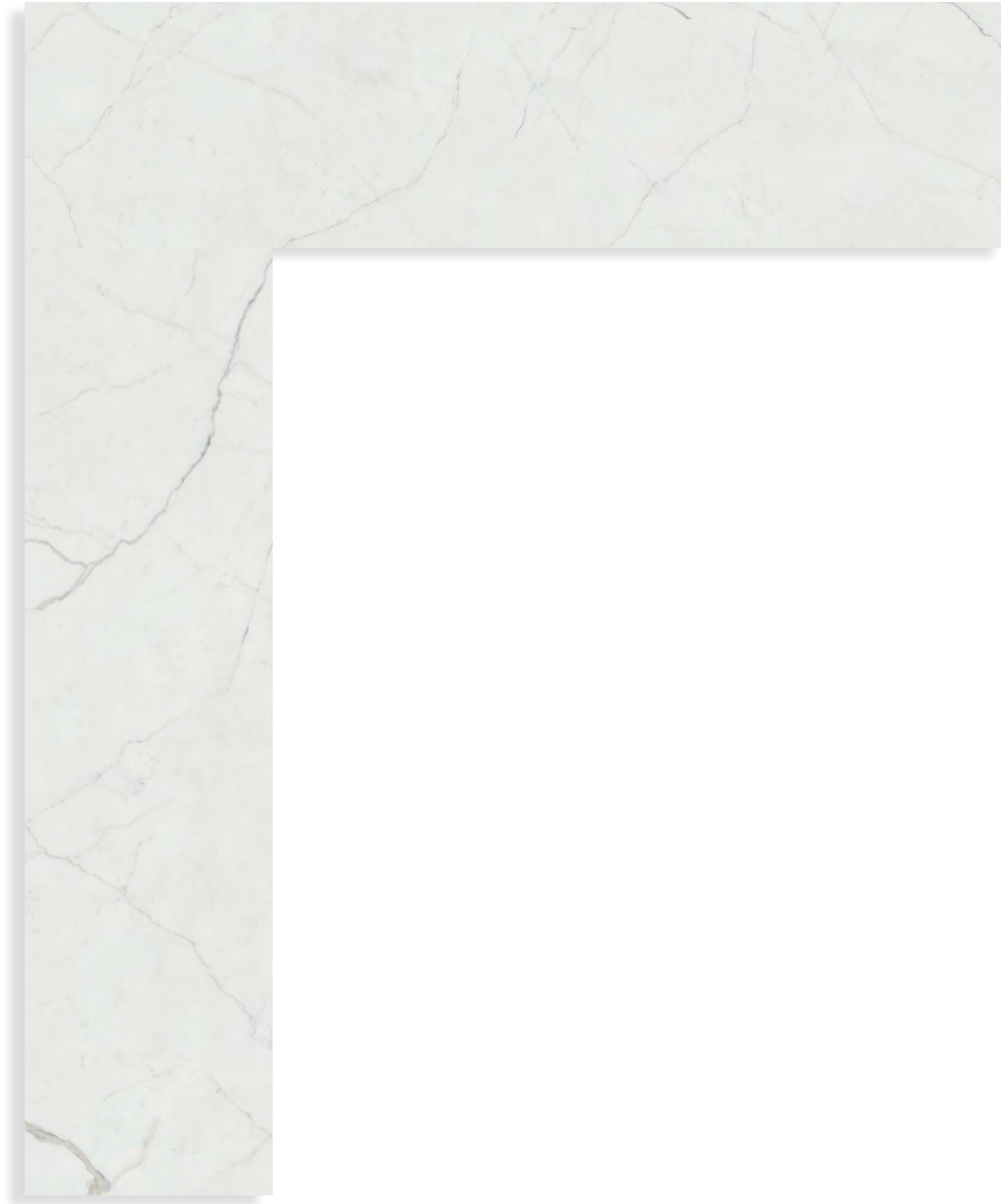

# 504 Lumena | Pattern continuity countertop to backsplash

1.

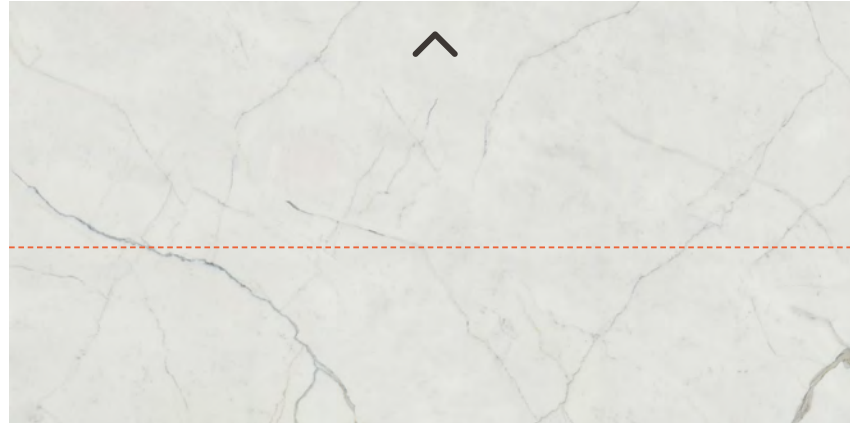

Cut the slab lengthwise

2.

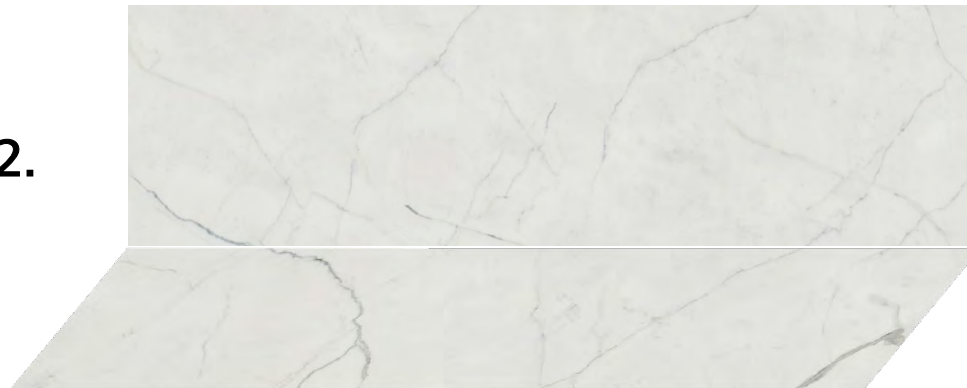

End result



# 504 Lumena | End result

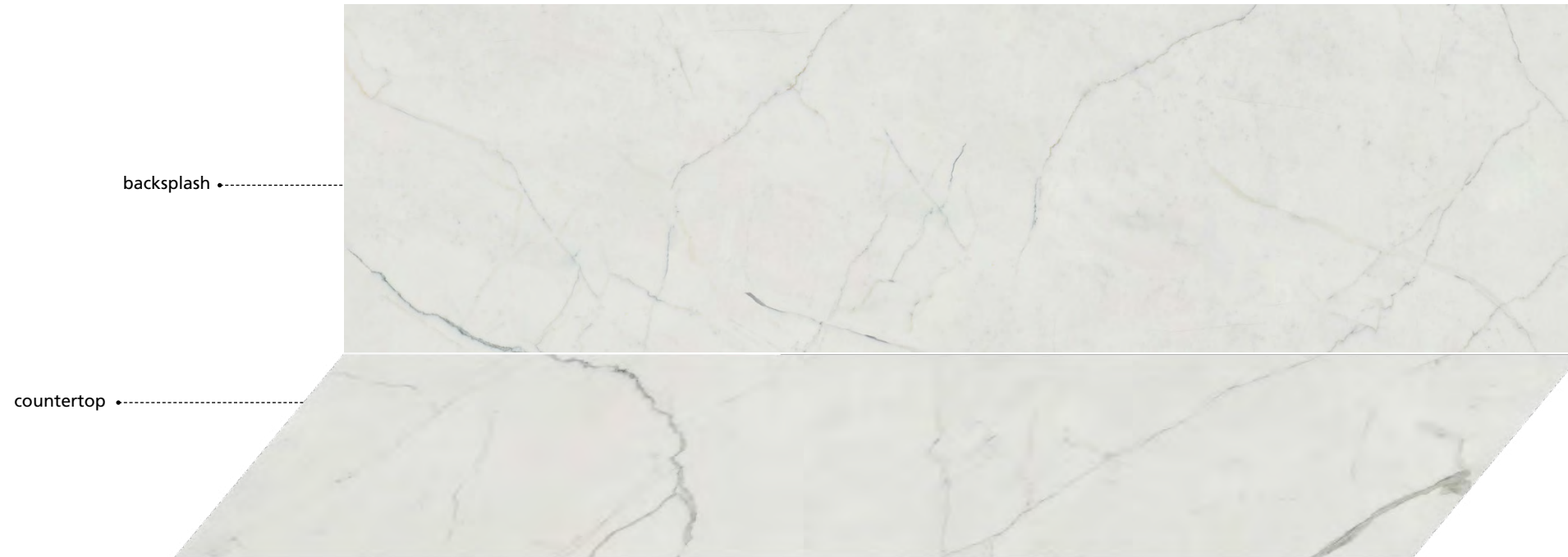

# 505 Archetta | Releasing slab tension

Full Slab

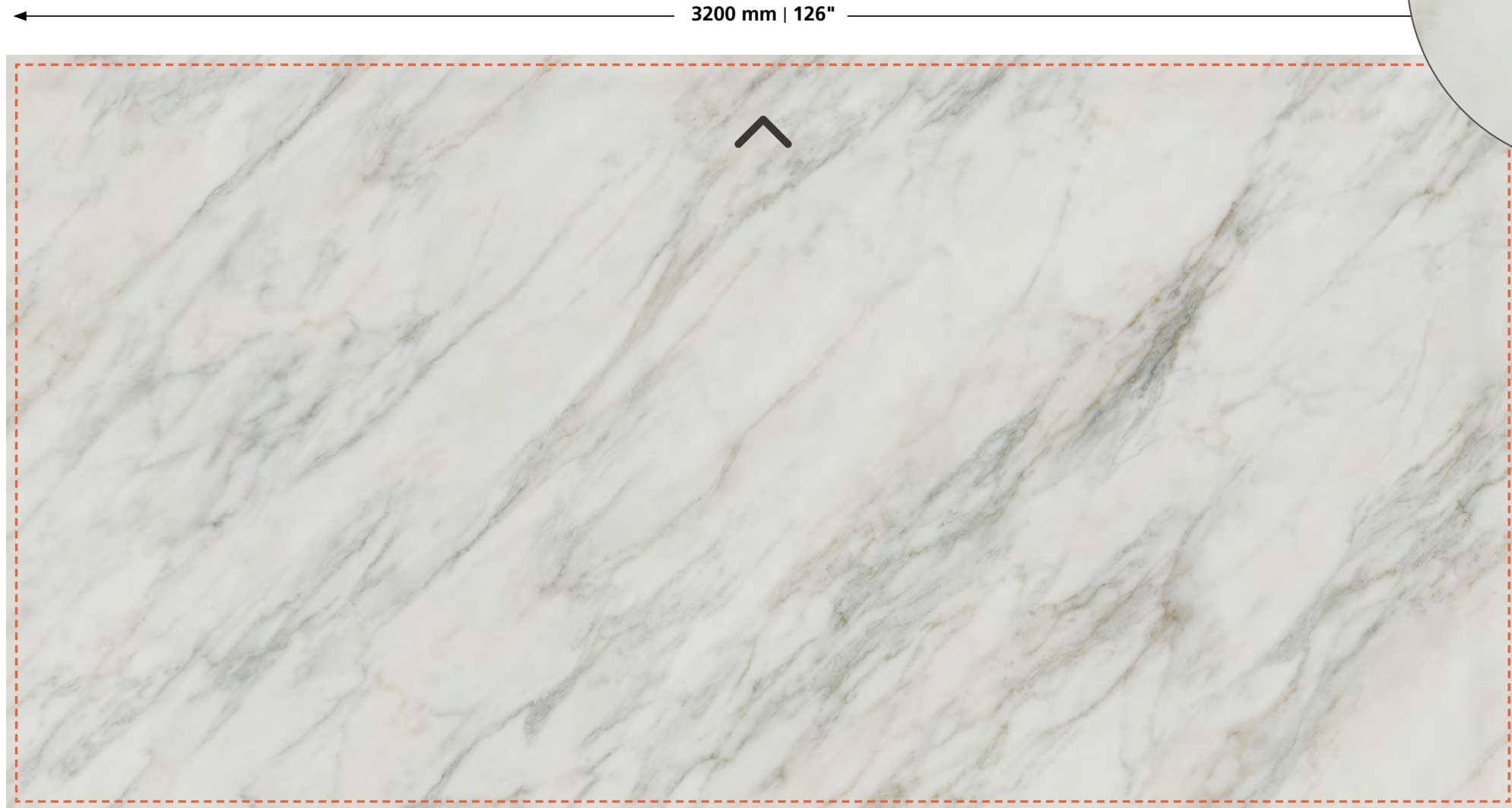

Reduce the 4 sides of the perimeter at a distance of 20-30 mm from the edges to release tension.

The useable slab size after releasing tension is 3160/3140 mm X 1560/1540 mm.

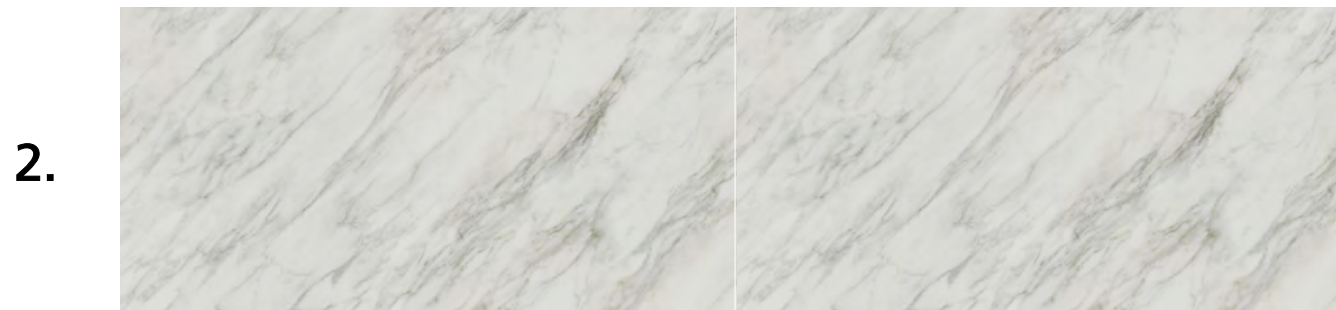
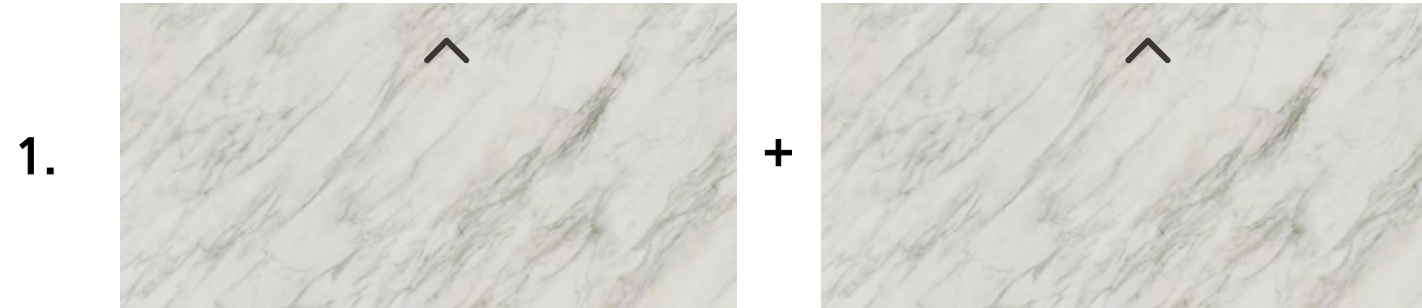

End result

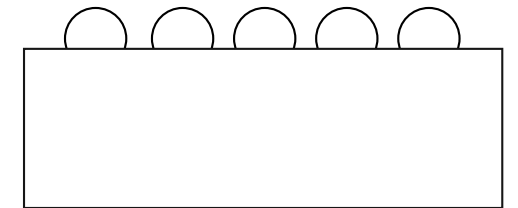

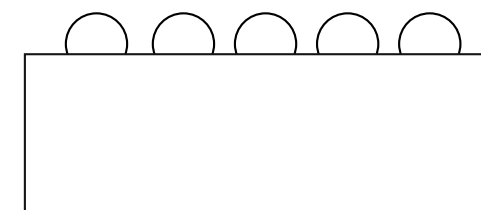
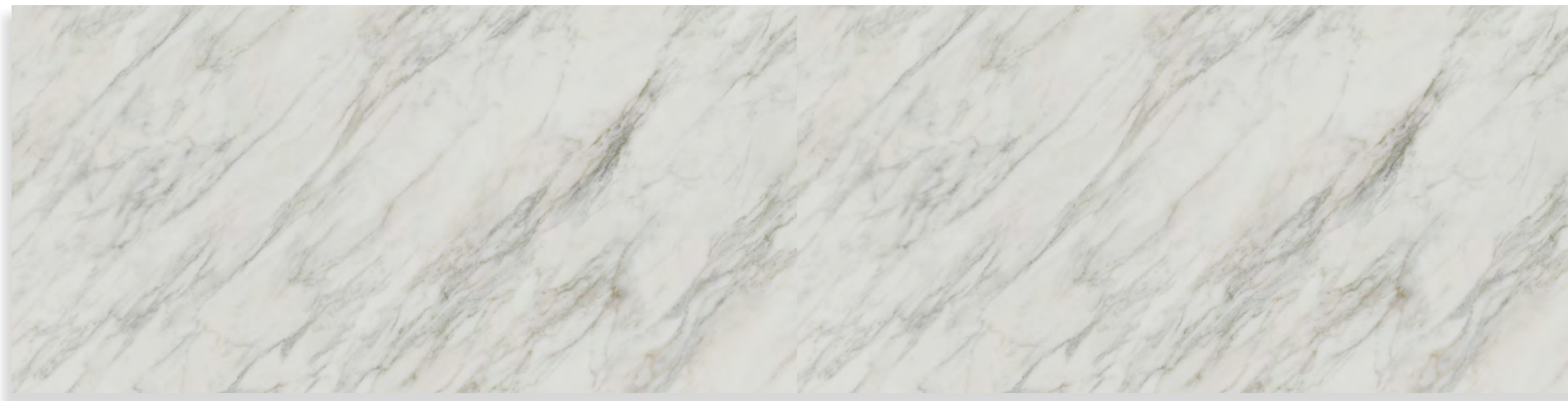

# 505 Archetta | Pattern continuity plan

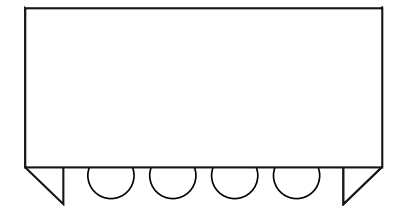
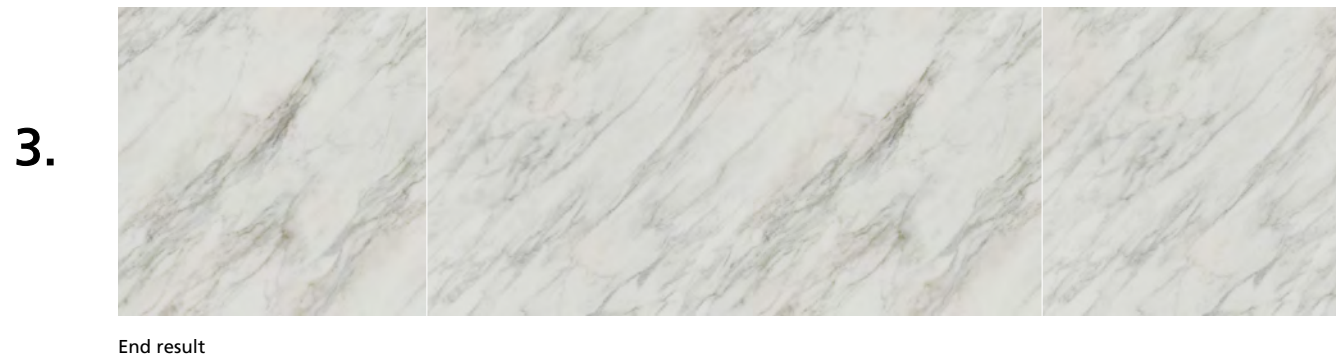
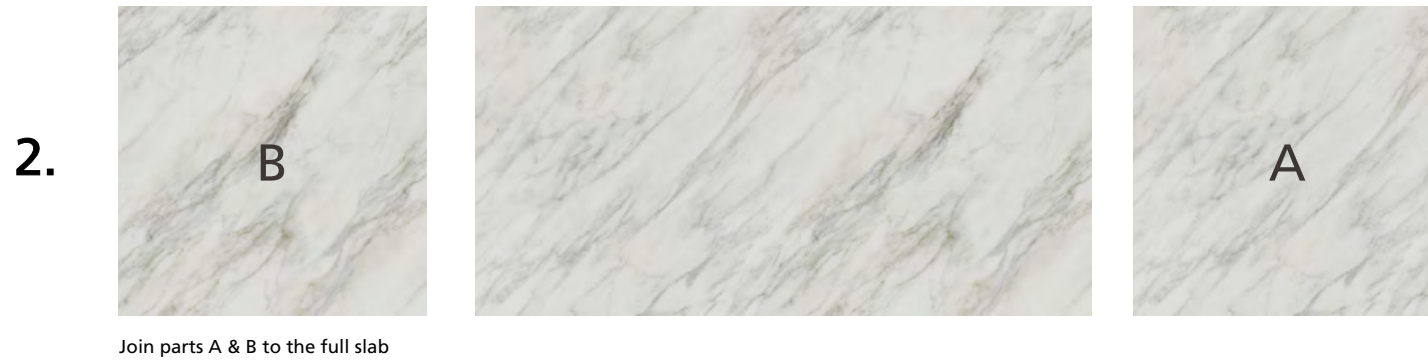

505 Archetta | End result

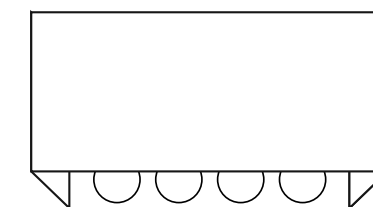
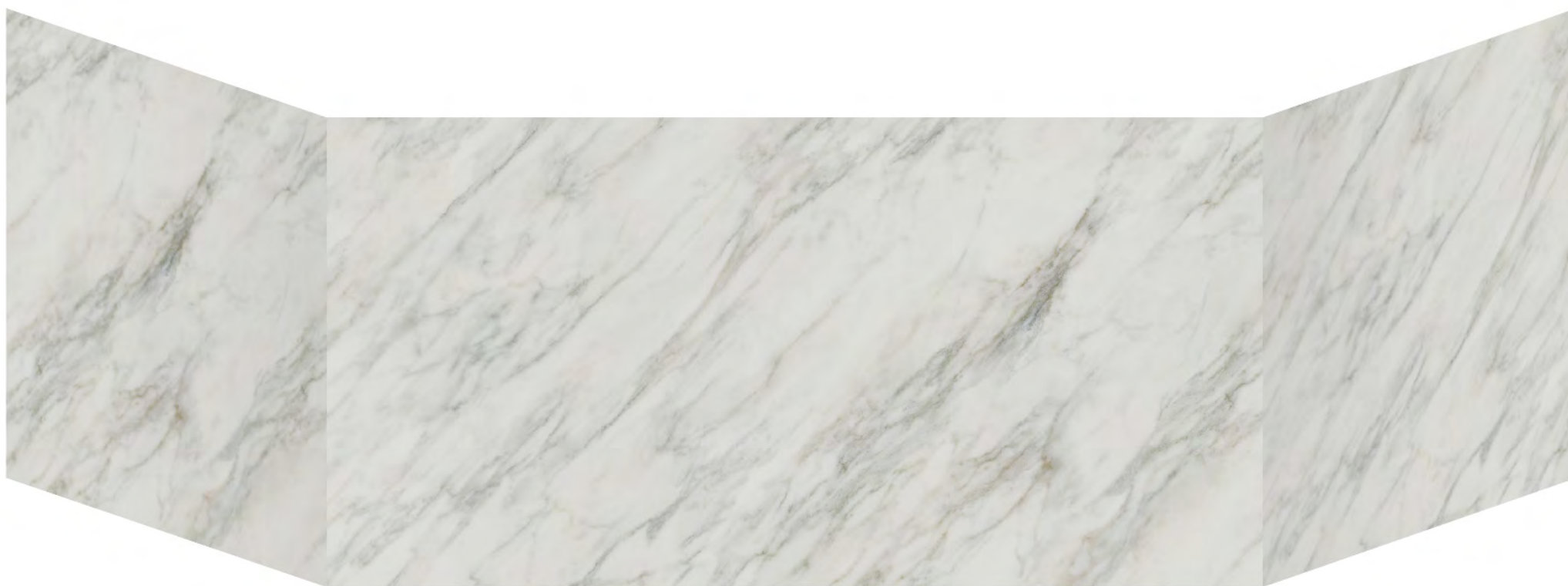

# 505 Archetta | Pattern continuity plan

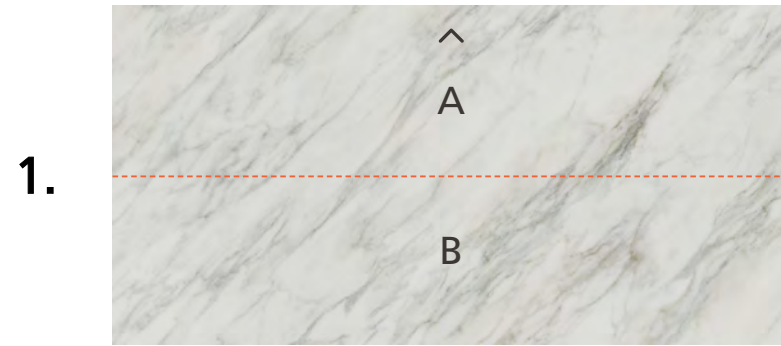

Cut the slab lengthwise

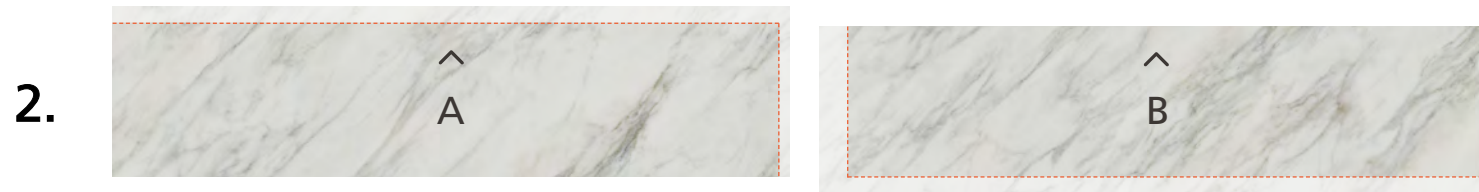

Plan to join parts A & B for continuation of the main veins and remove the surplus

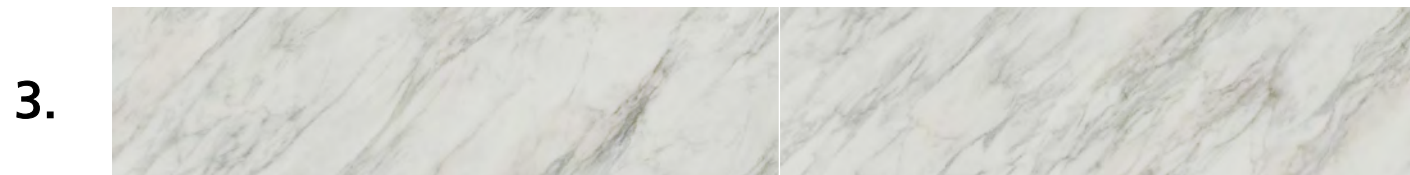

End result

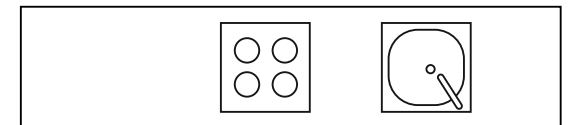

# 505 Archetta | End result

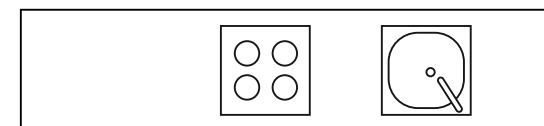
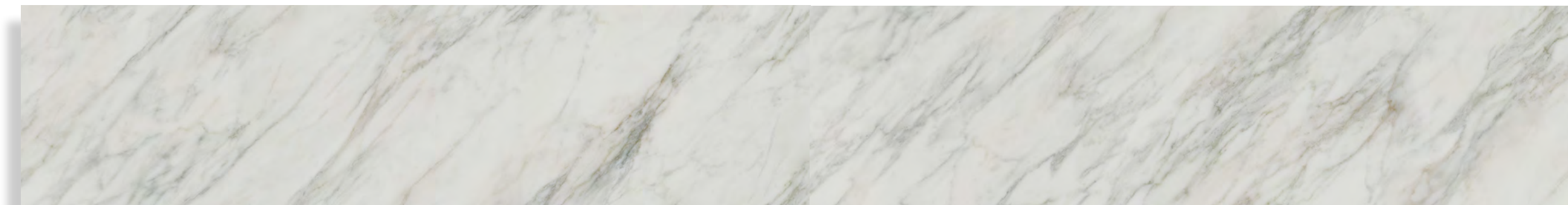

1.

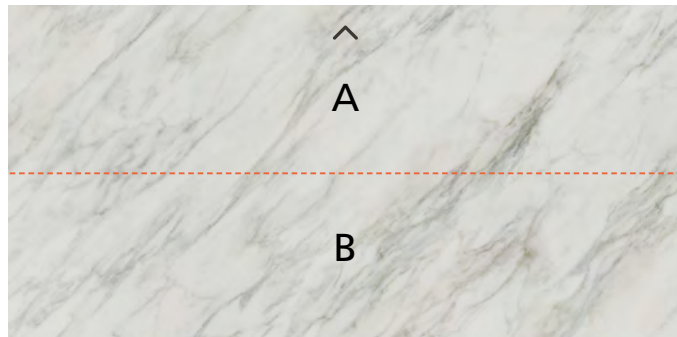

Cut the slab lengthwise

2.

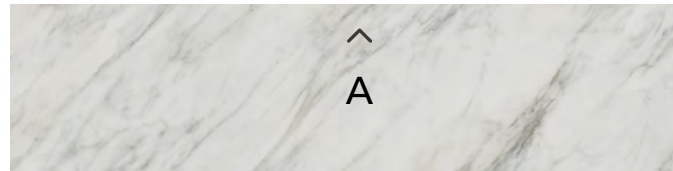
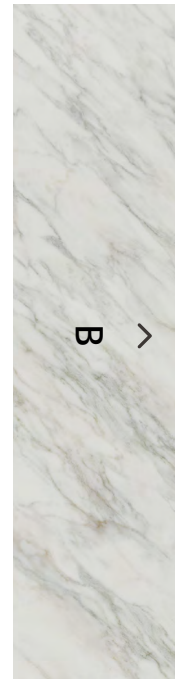

Rotate part B 90° and join parts A & B

3.

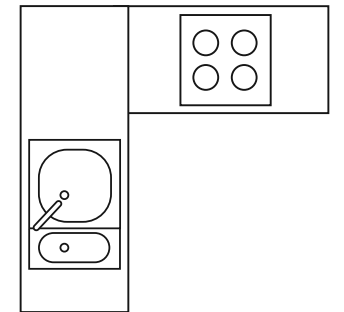
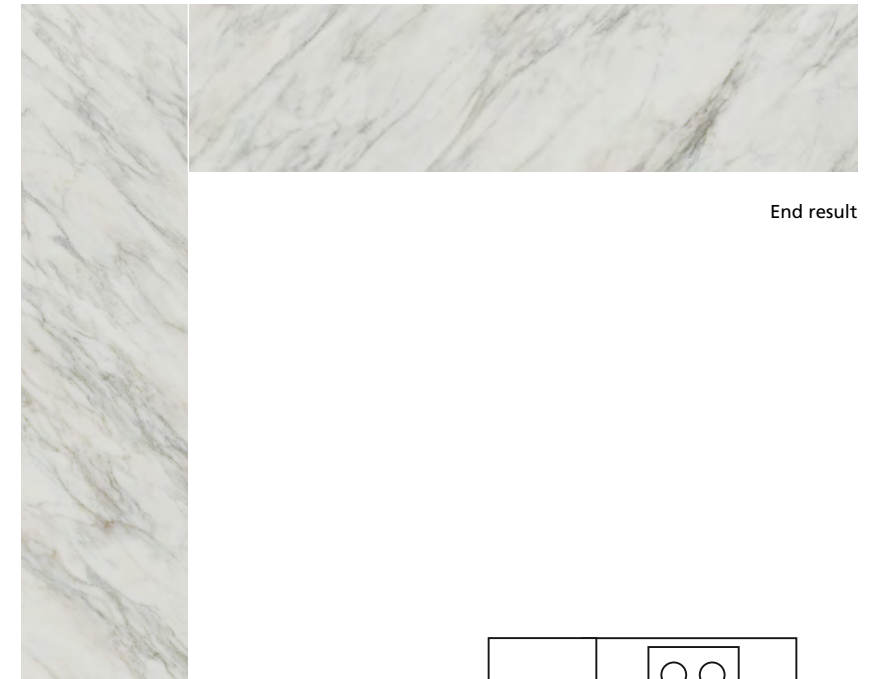

505 Archetta | End result

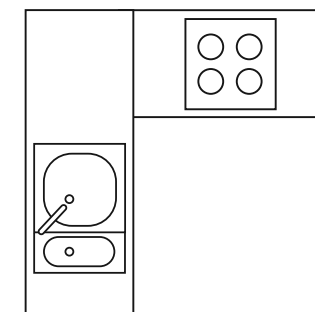
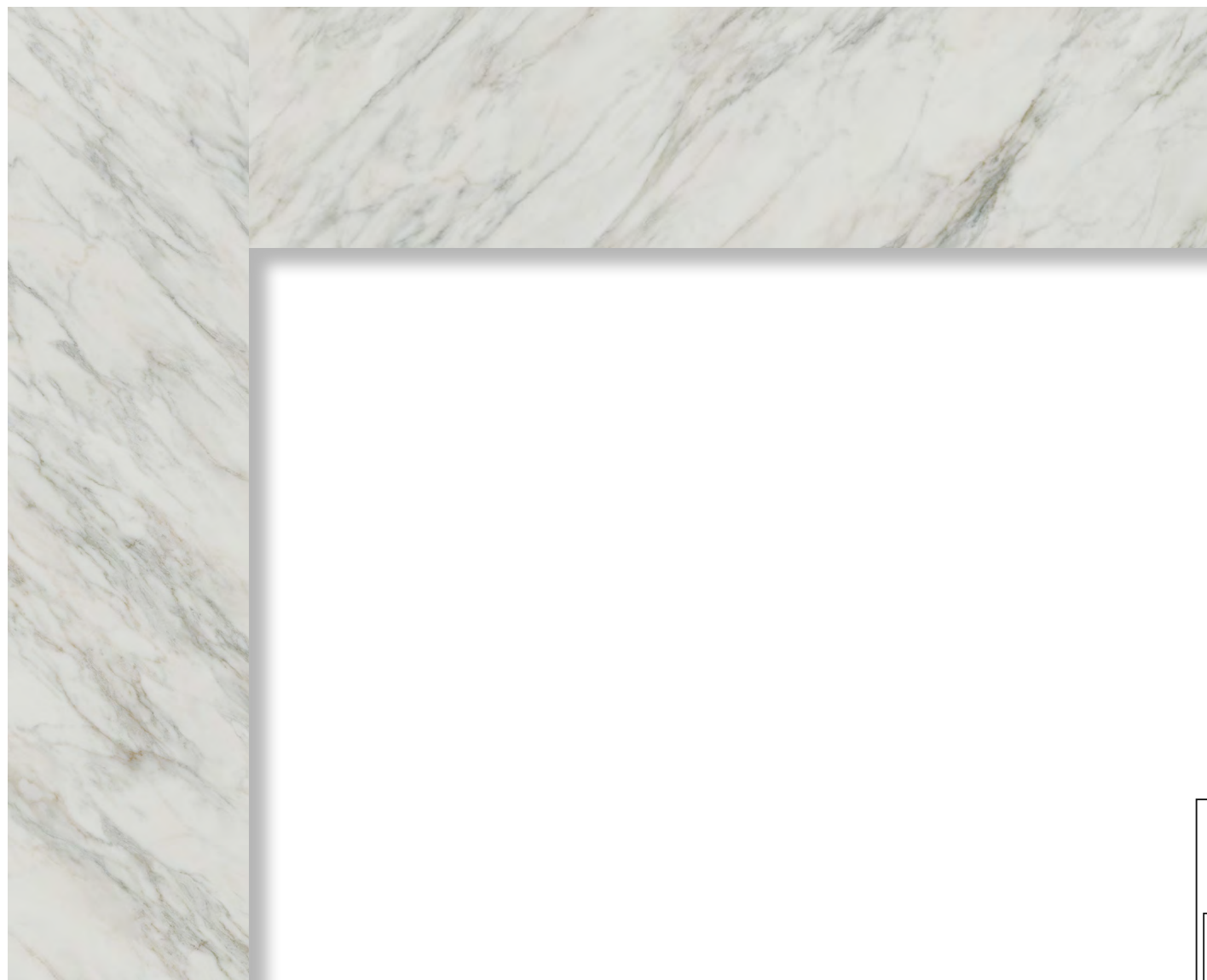

# 505 Archetta | Pattern continuity countertop to backsplash

1.

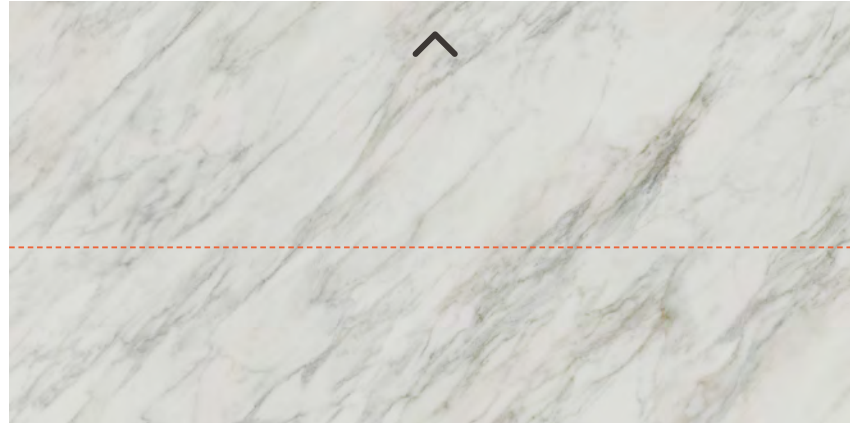

Cut the slab lengthwise

2.

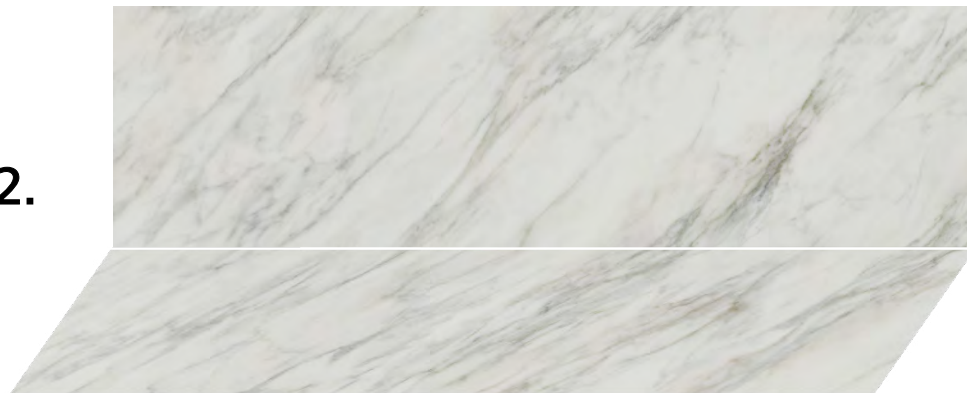

End result



505 Archetta | End result

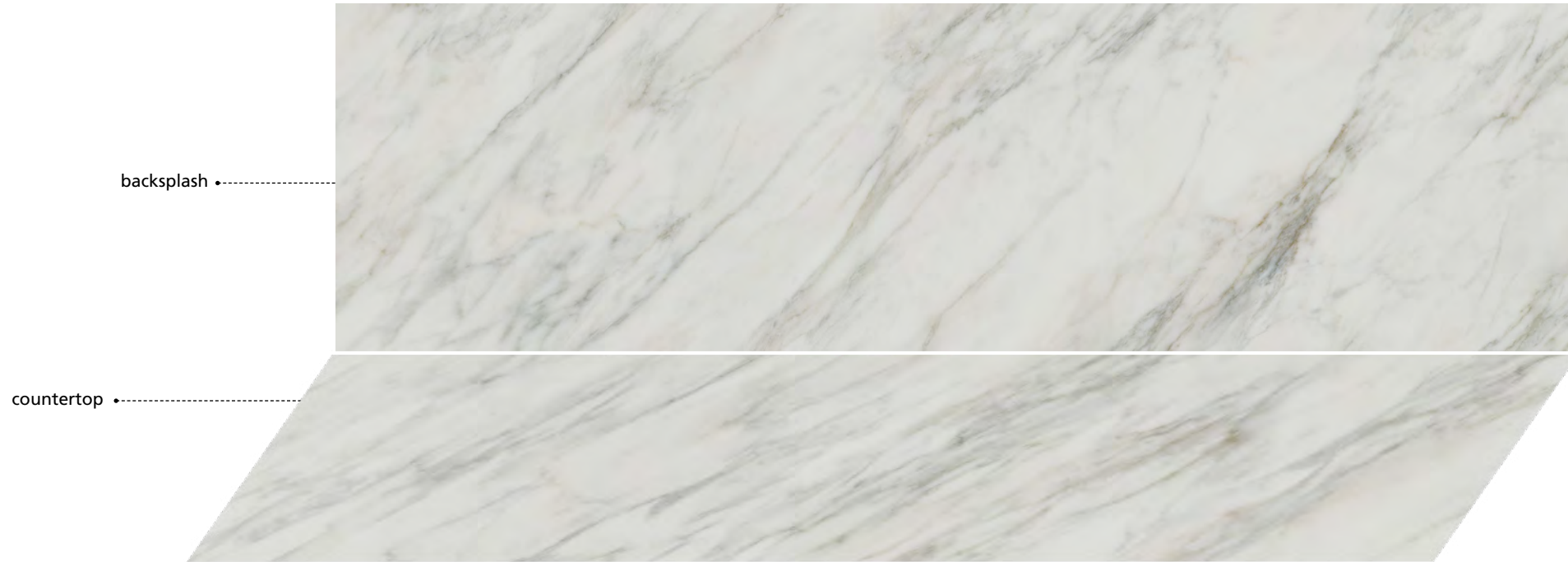

# 506 Mirabel | Releasing slab tension

Full Slab

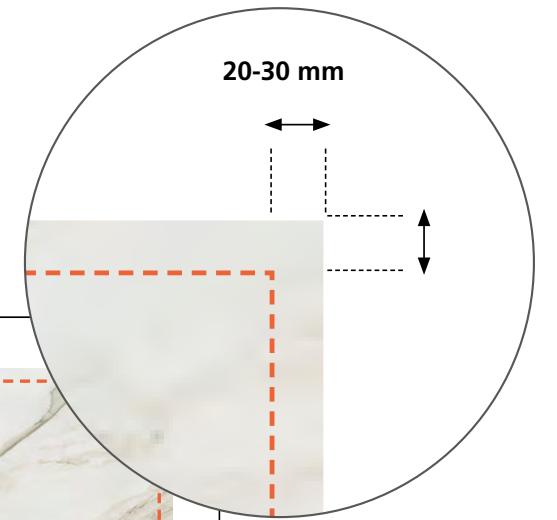
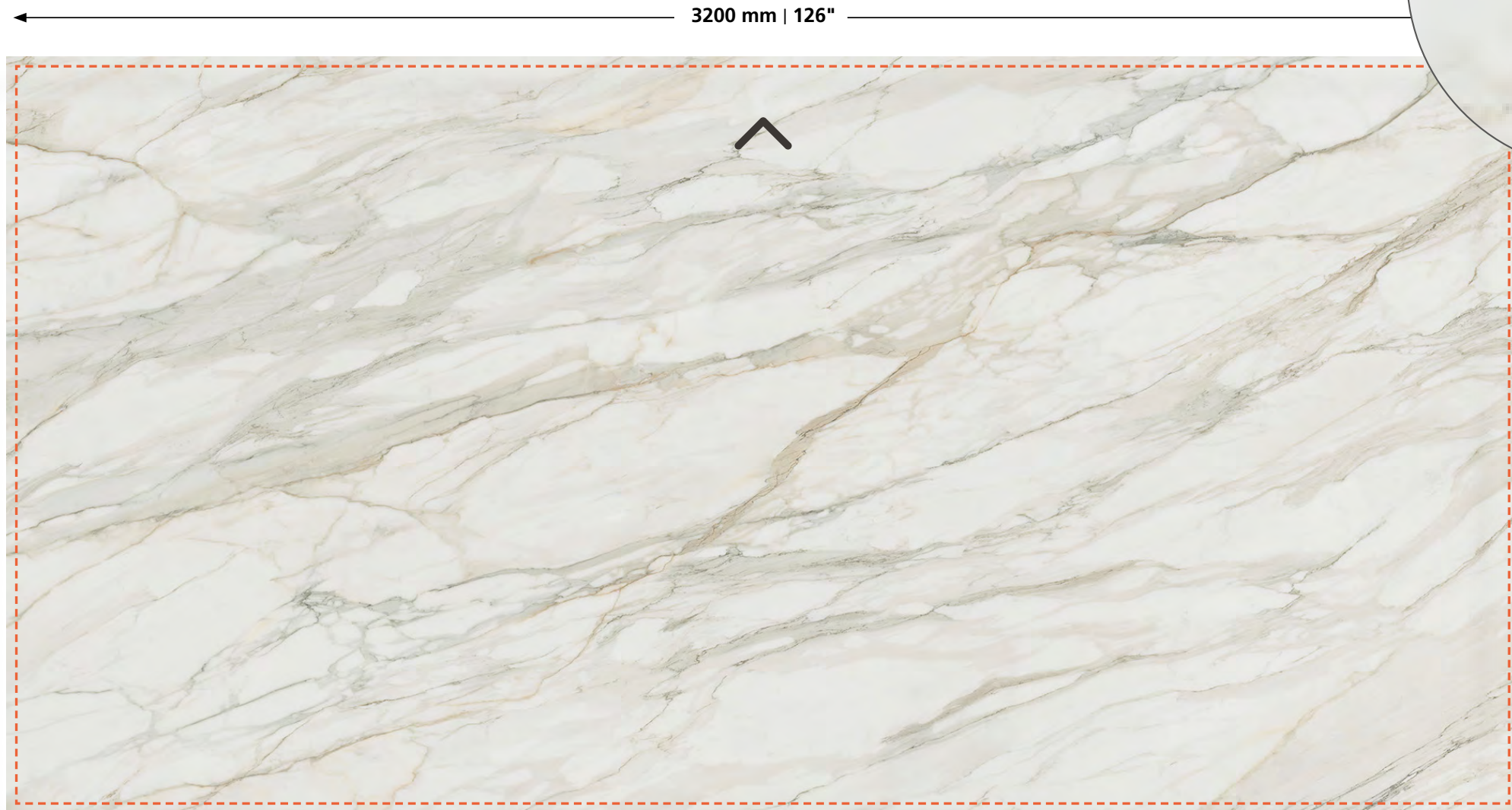

Reduce the 4 sides of the perimeter at a distance of 20-30 mm from the edges to release tension.

The useable slab size after releasing tension is 3160/3140 mm X 1560/1540 mm. (124<sup>3</sup>/<sub>8</sub>"/123<sup>5</sup>/<sub>8</sub>" X 61<sup>1</sup>/<sub>2</sub>"/60<sup>5</sup>/<sub>8</sub>" )

1600 mm | 63"

# 506 Mirabel | Pattern continuity plan

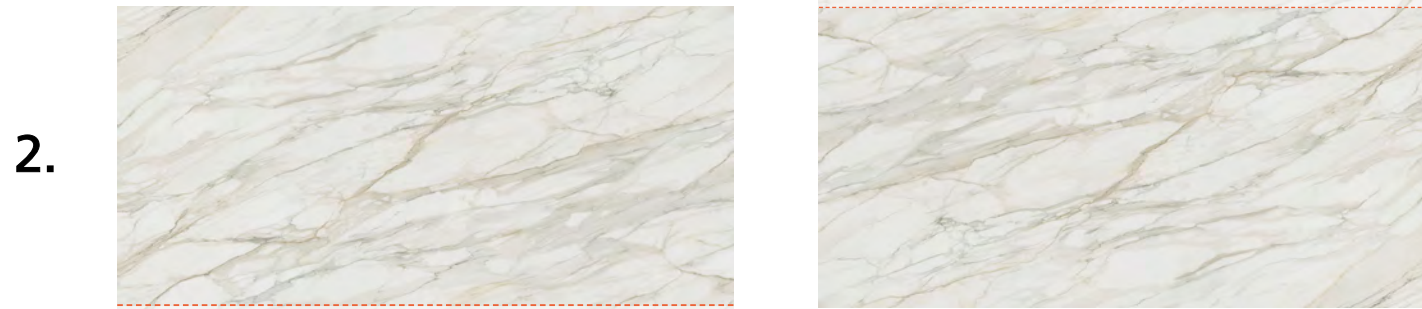

Plan to join the two slabs for continuation of the main veins and remove the surplus

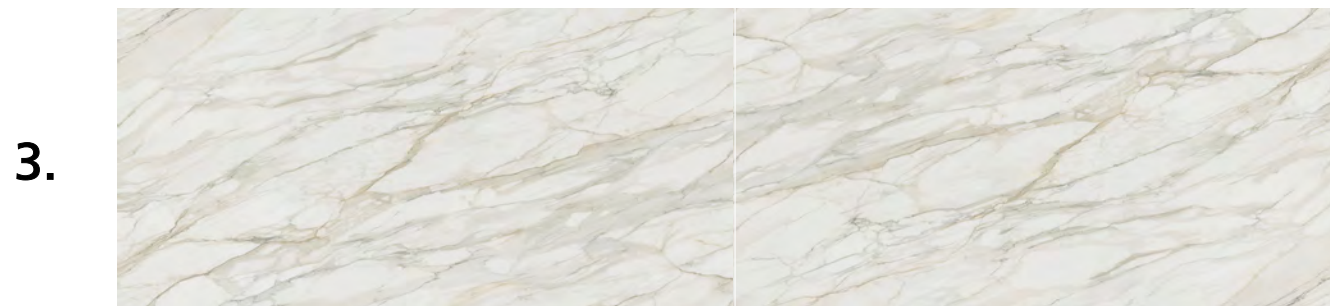

End result

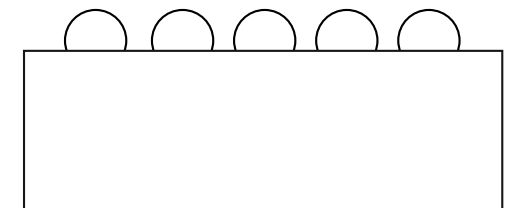

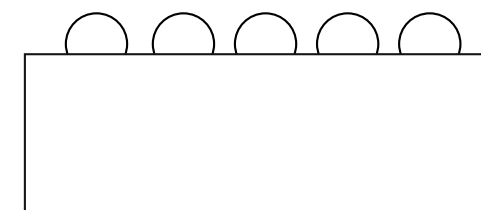

# 506 Mirabel | Pattern continuity plan

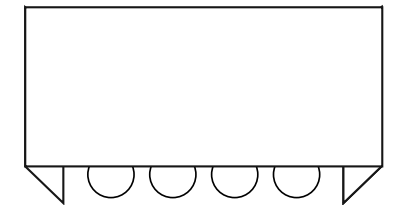
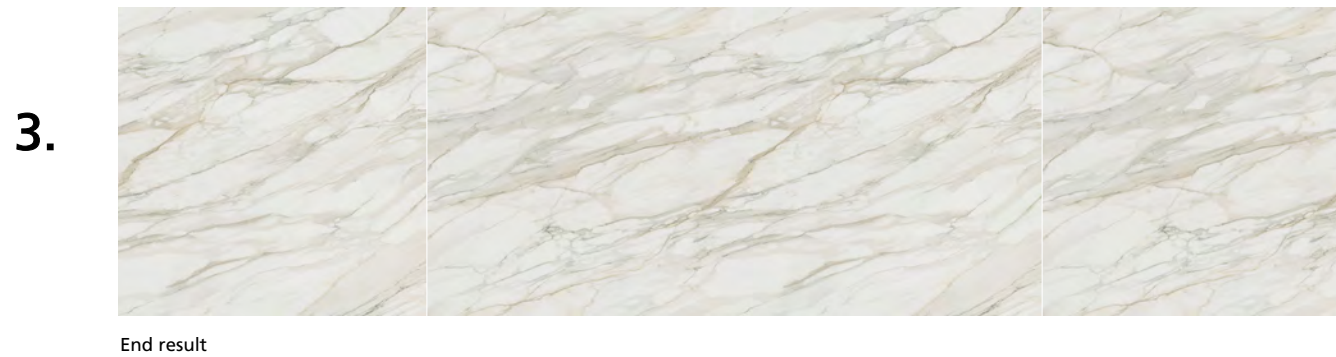
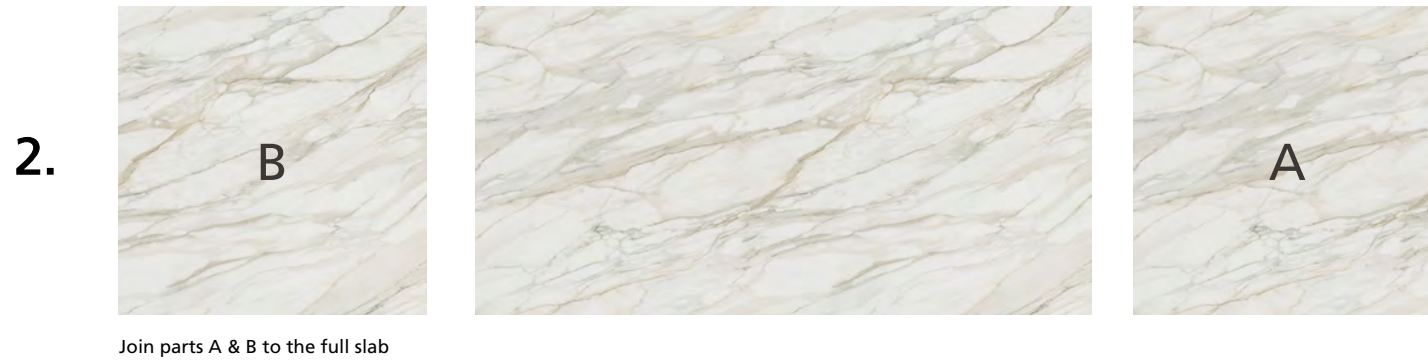

506 Mirabel | End result

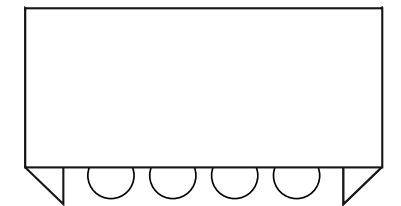
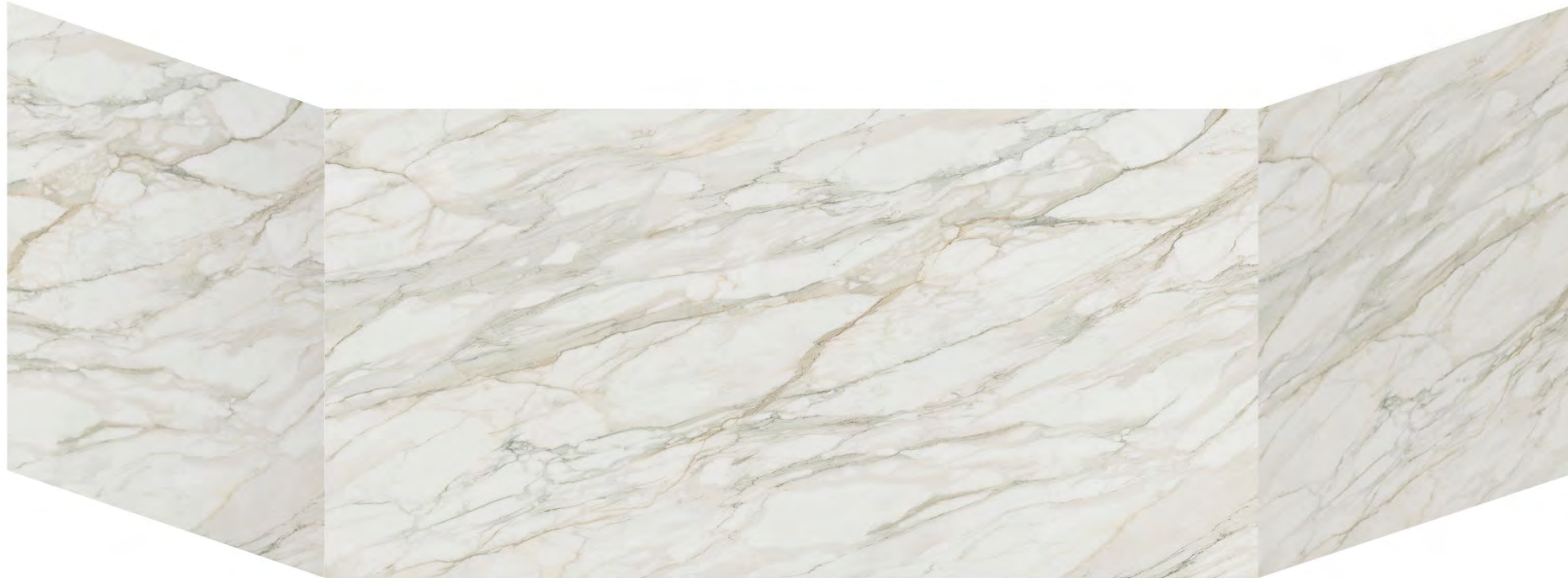

# 506 Mirabel | Pattern continuity plan

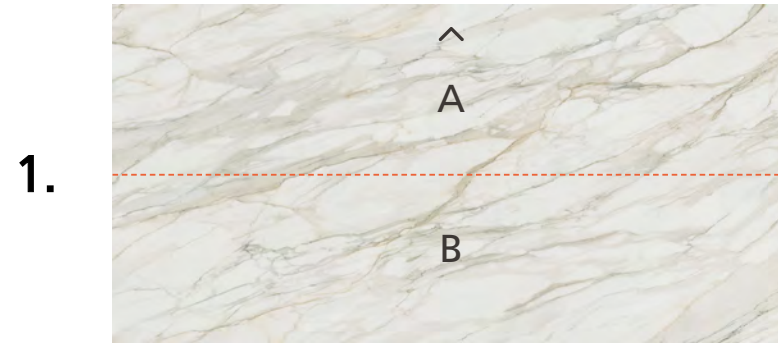

Cut the slab lengthwise



Join parts A & B

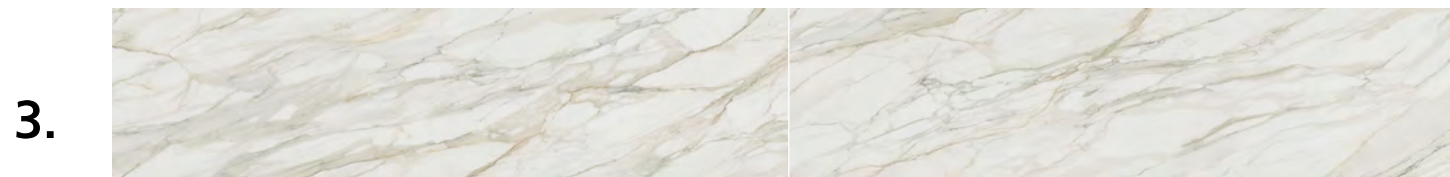
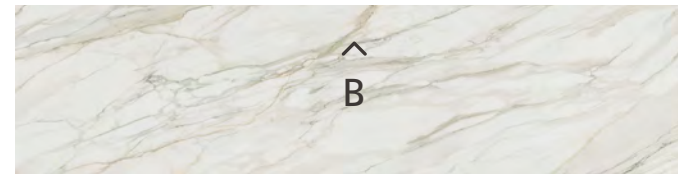

End result

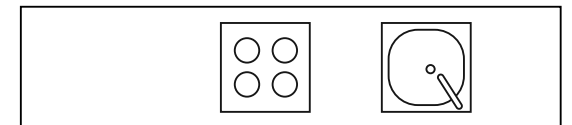

506 Mirabel | End result

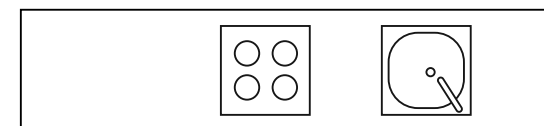
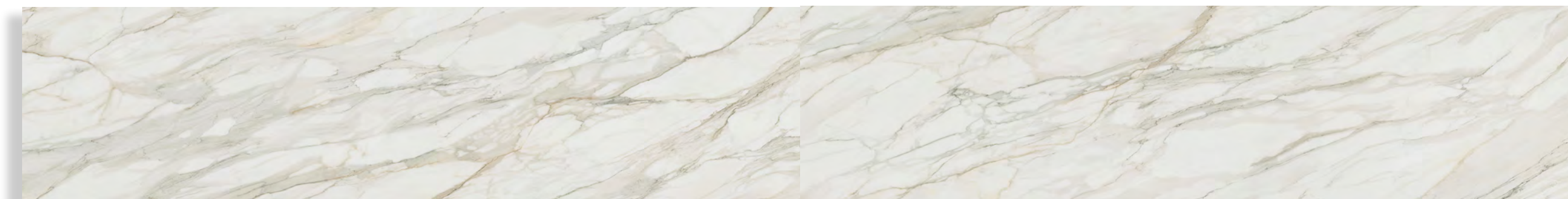

# 506 Mirabel | Pattern continuity L-shape

1.

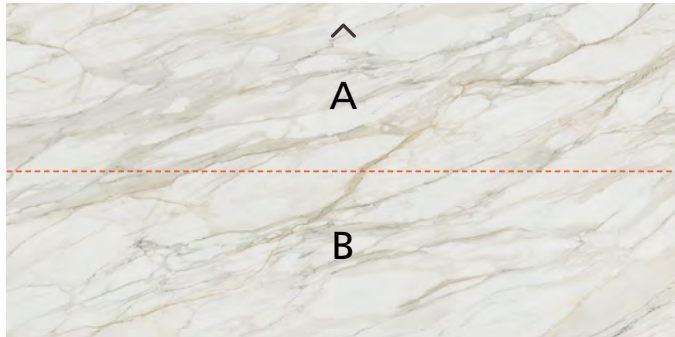

Cut the slab lengthwise

2.

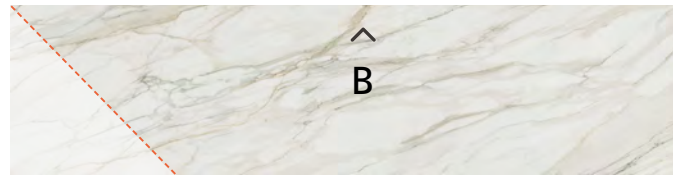

Rotate part A (90°. Plan to join parts A & B for pattern continuity and remove the surplus.



3.



End result

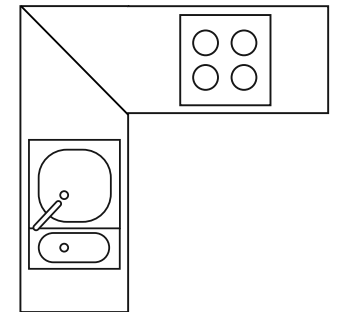

506 Mirabel | End result

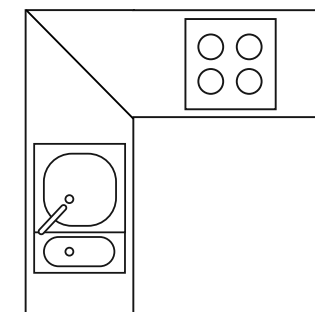

506 Mirabel | Pattern continuity countertop to backsplash

1.

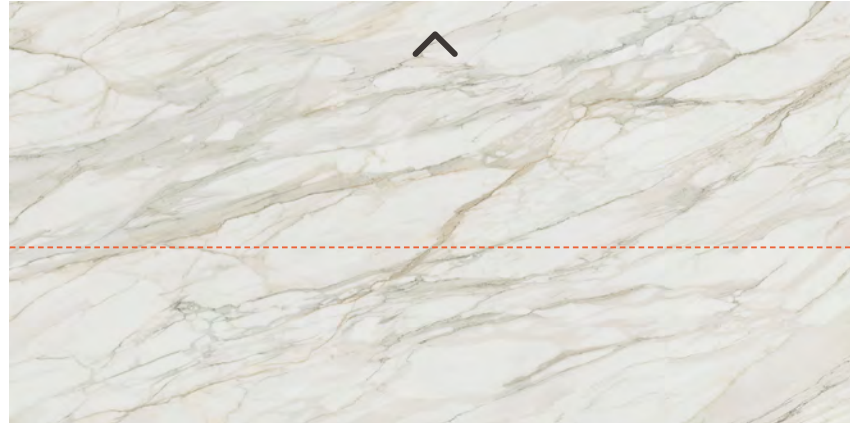

Cut the slab lengthwise

2.

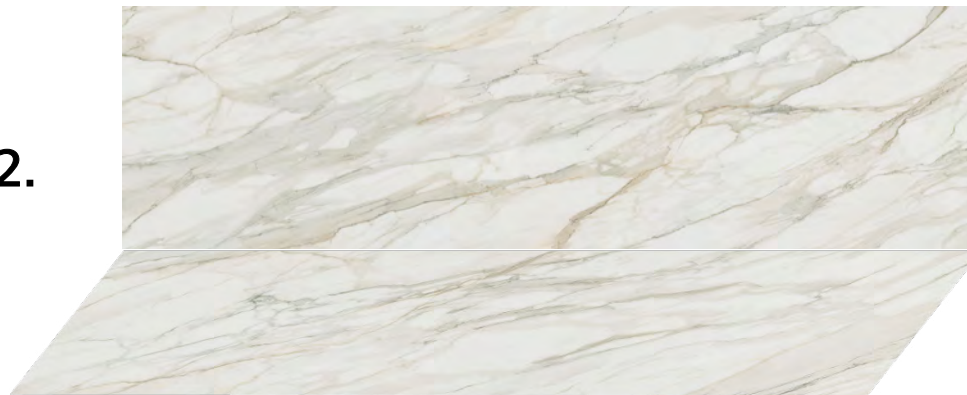

End result



# 506 Mirabel | End result

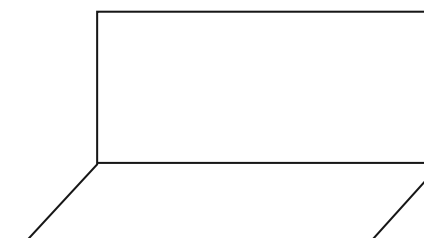
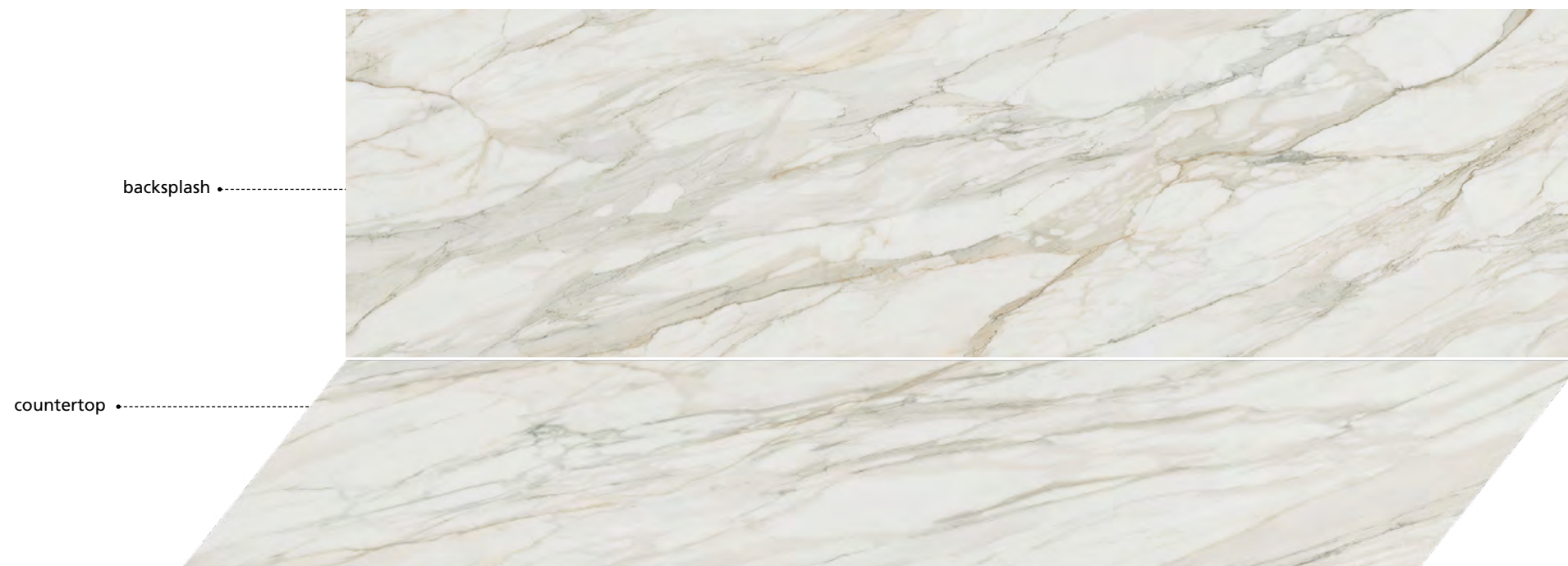

# 507 Marbannova | Releasing slab tension

Full Slab

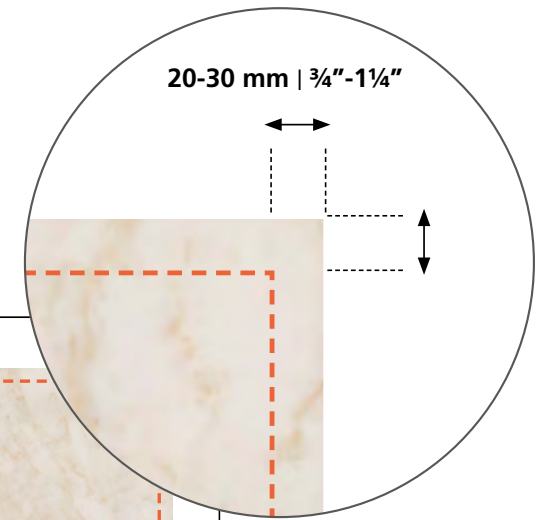

Reduce the 4 sides of the perimeter at a distance of 20-30 mm from the edges to release tension.

The useable slab size after releasing tension is 3160/3140 mm X 1560/1540 mm. (124<sup>3</sup>/<sub>8</sub>"/123<sup>5</sup>/<sub>8</sub>" X 61<sup>1</sup>/<sub>2</sub>"/60<sup>5</sup>/<sub>8</sub>" )

# 507 Marbannova | Pattern continuity plan

1.



Rotate one slab 180°

2.



End result

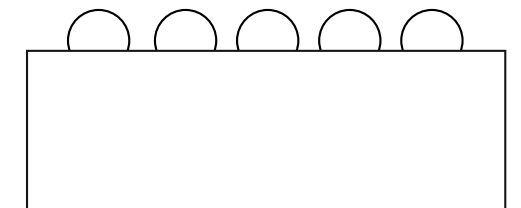

507 Marbannova | End result

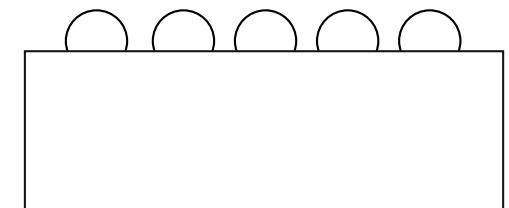

# 507 Marbannova | Pattern continuity plan

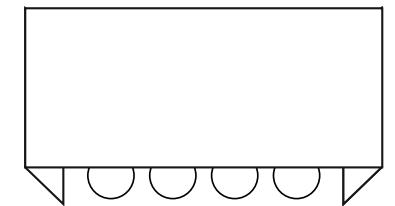
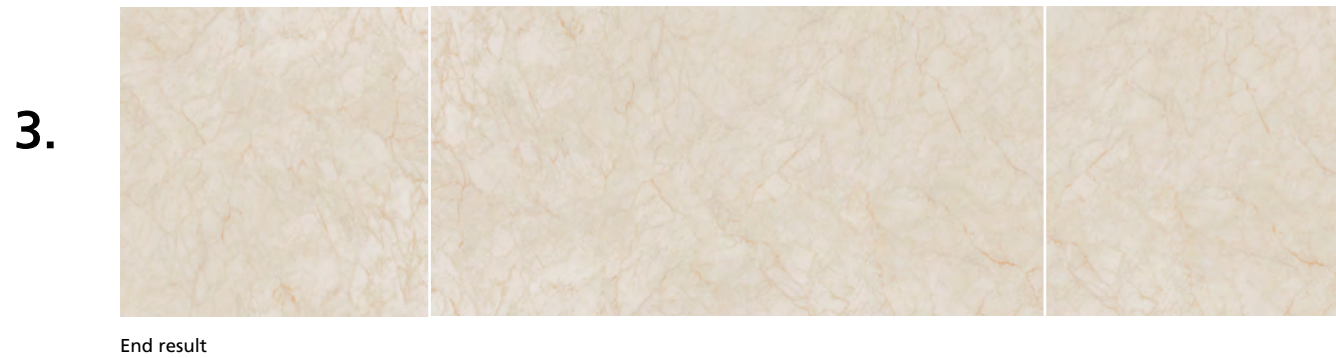

507 Marbannova | End result

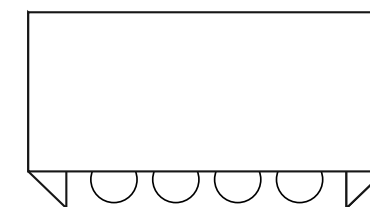
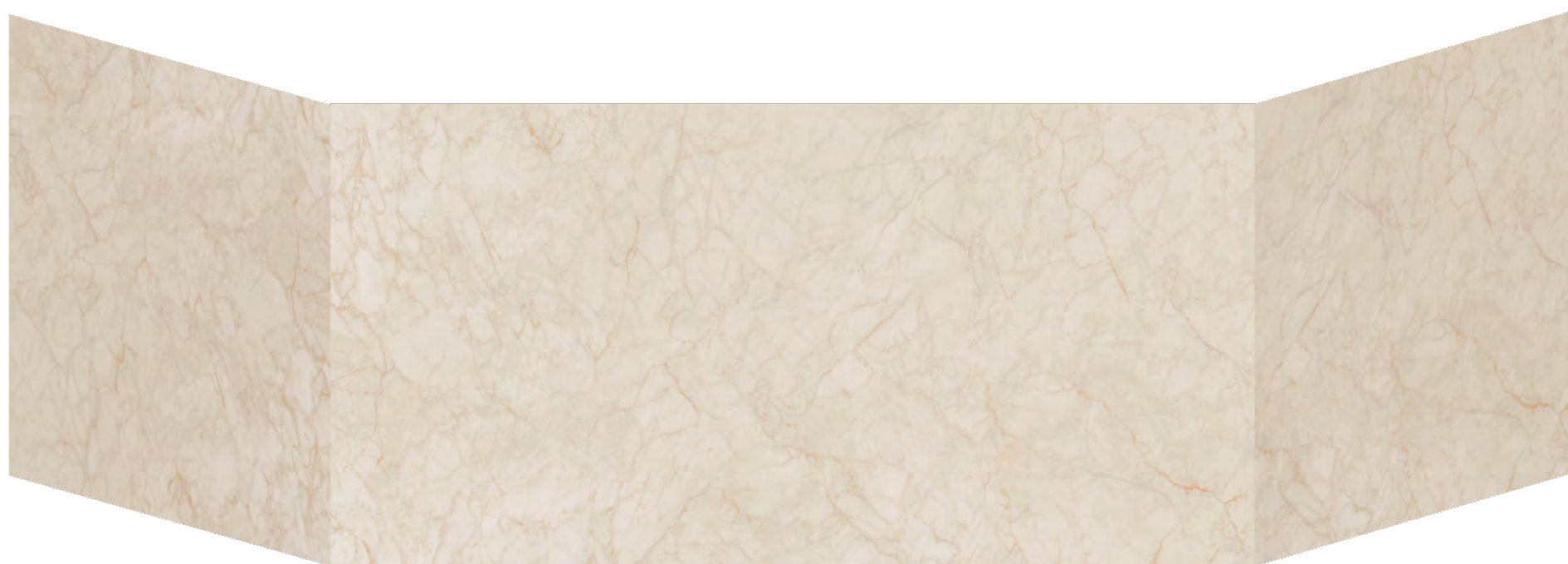

# 507 Marbannova | Pattern continuity plan

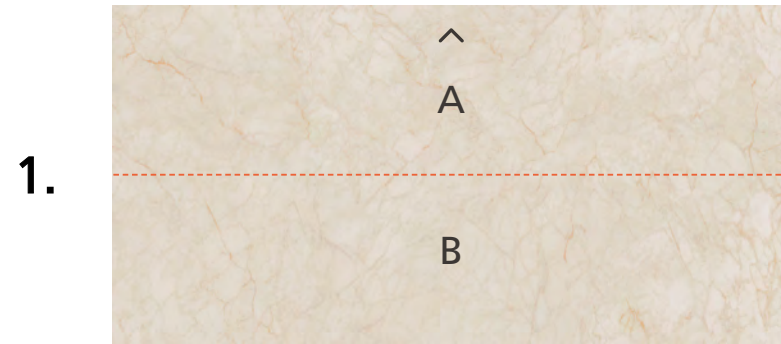

Cut the slab lengthwise

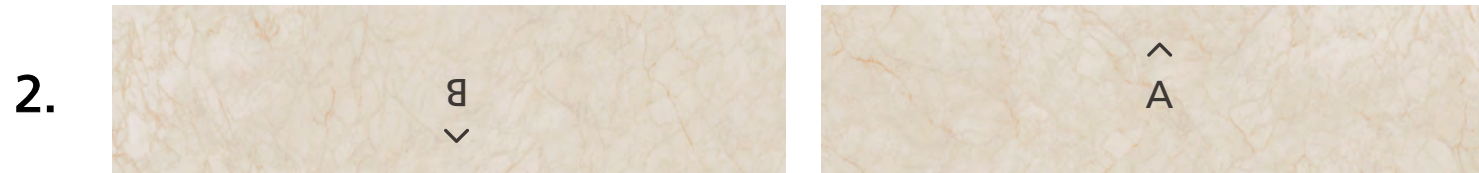

Rotate part B 180° and join parts A & B

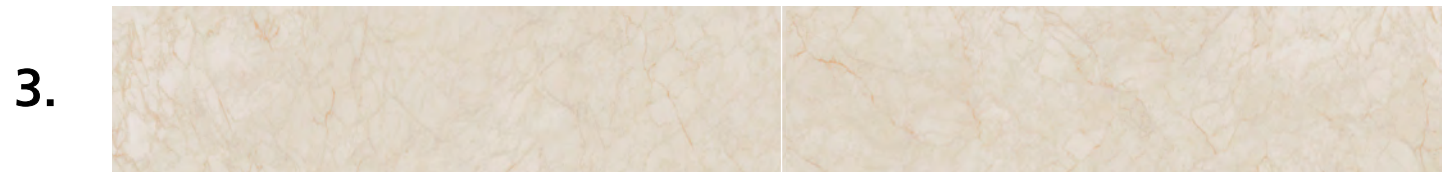

End result

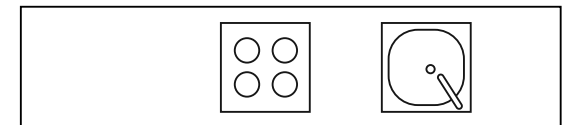

# 507 Marbannova | End result

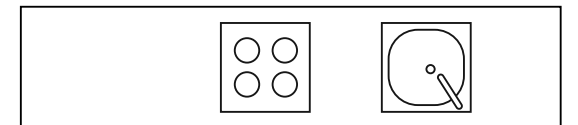
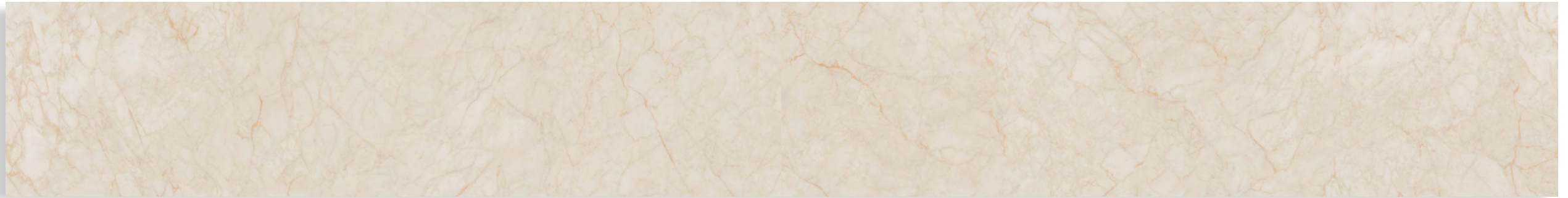

# 507 Marbannova | Pattern continuity L-shape

1.

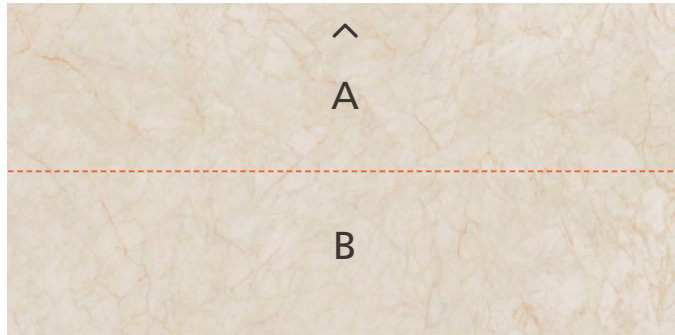

Cut the slab lengthwise

2.

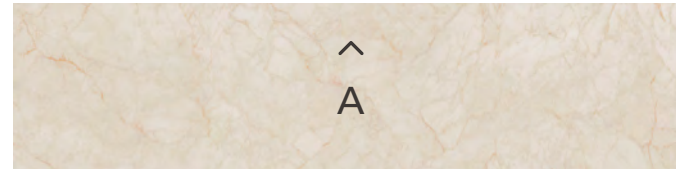

Rotate part B 90° and join parts A & B

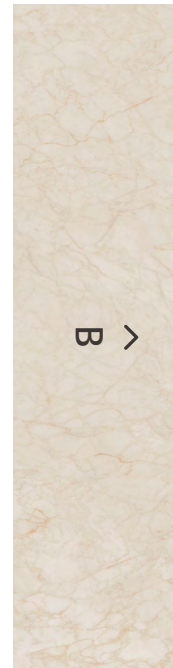

3.

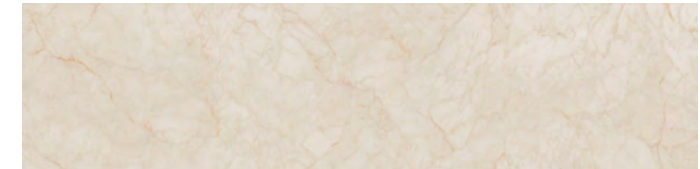

End result

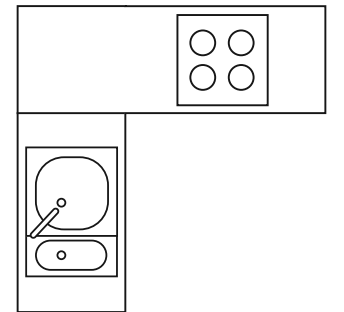
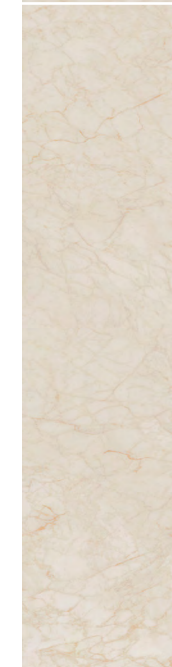

507 Marbannova | End result

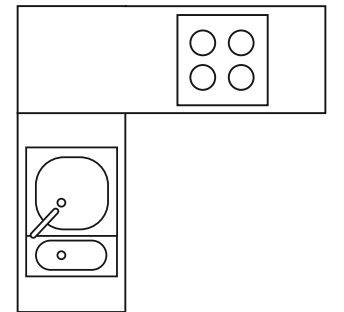
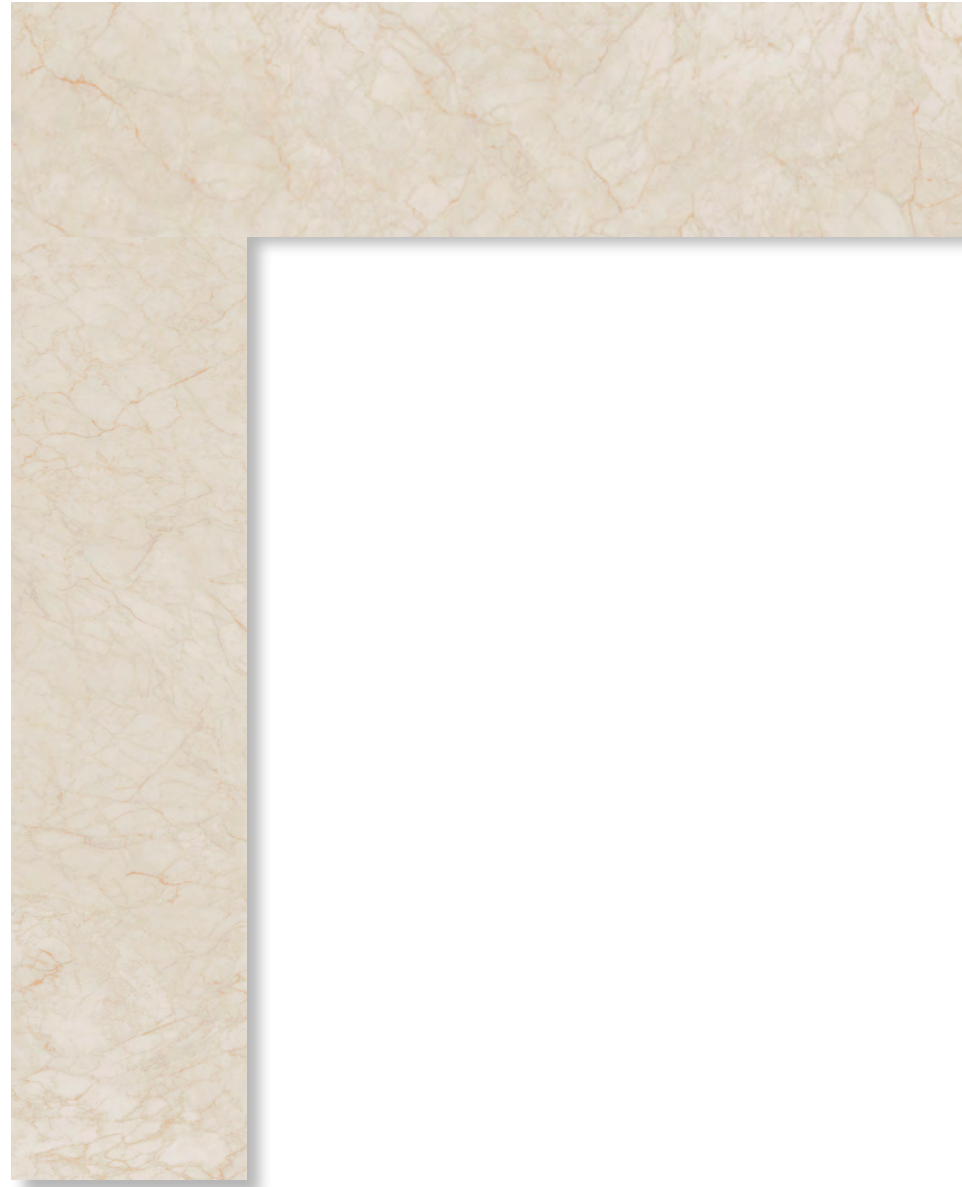

# 507 Marbannova | Pattern continuity countertop to backsplash

1.



Cut the slab lengthwise

2.

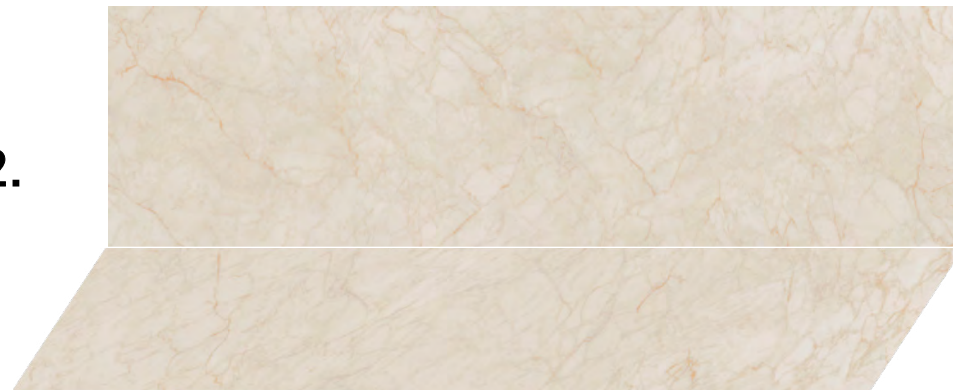

End result



# 507 Marbannova | End result

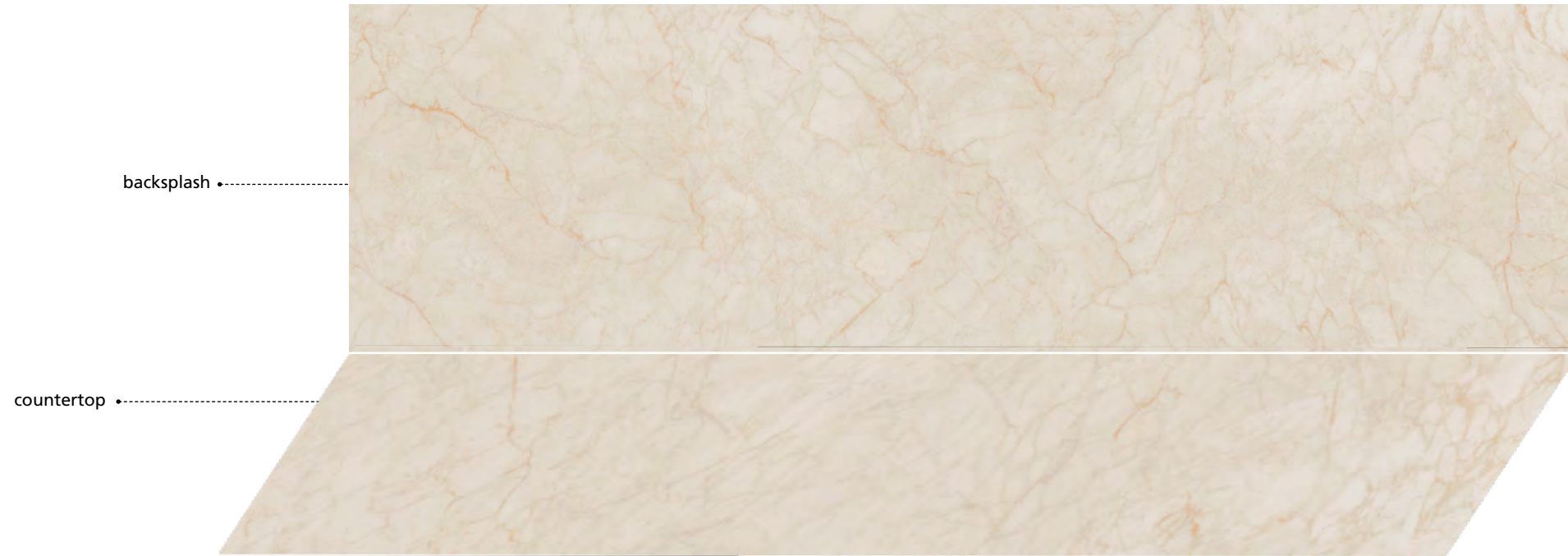

# 508 Isobellia | Releasing slab tension

Full Slab

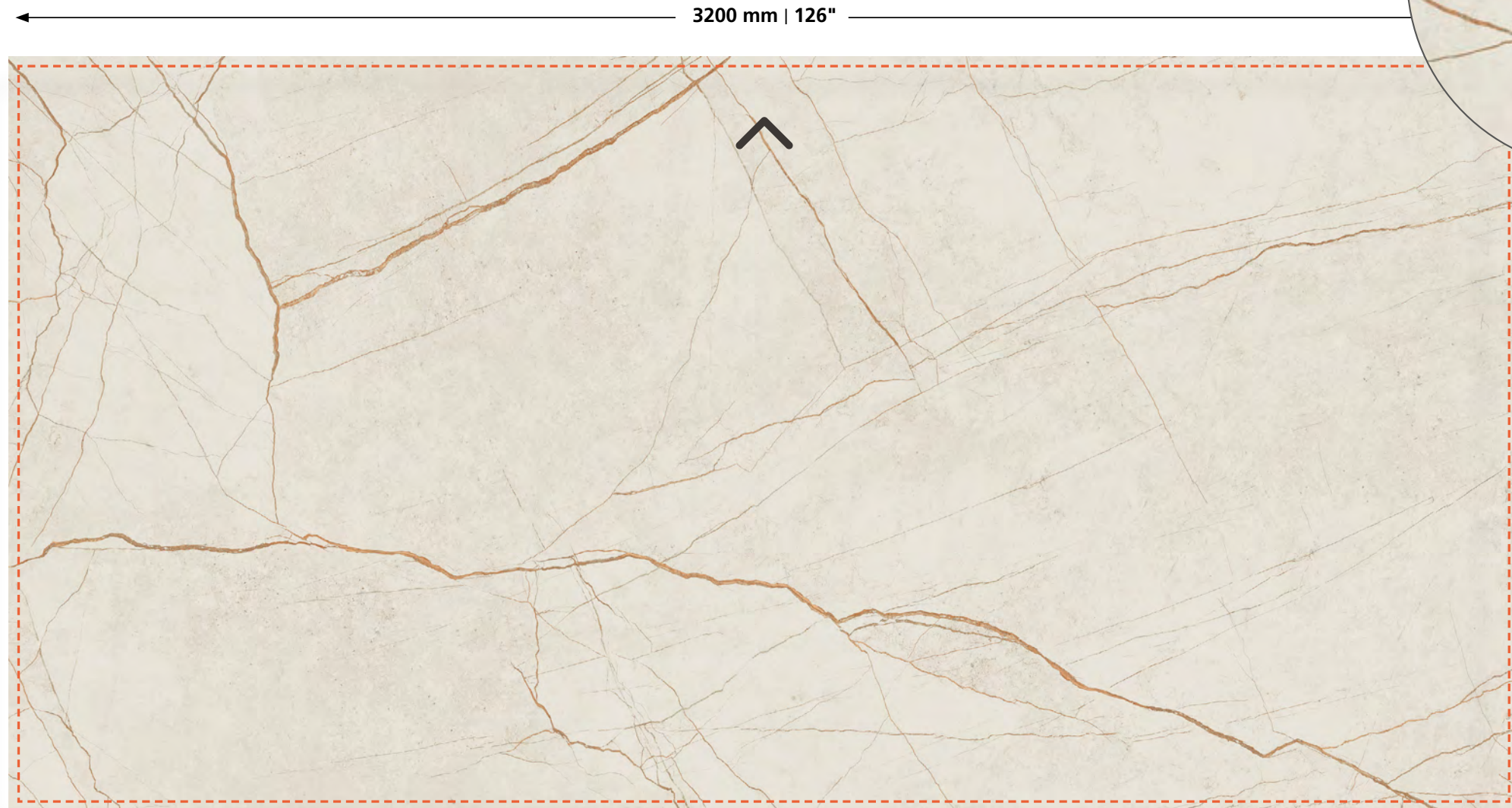

Reduce the 4 sides of the perimeter at a distance of 20-30 mm from the edges to release tension.

The useable slab size after releasing tension is 3160/3140 mm X 1560/1540 mm. (124<sup>3</sup>/<sub>8</sub>"/123<sup>5</sup>/<sub>8</sub>" X 61<sup>1</sup>/<sub>2</sub>"/60<sup>5</sup>/<sub>8</sub>" )

# 508 Isobellia | Pattern continuity plan

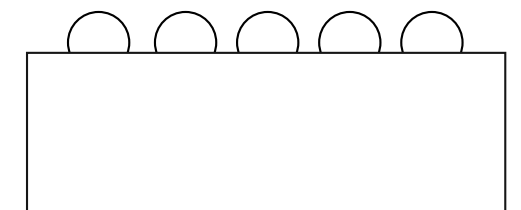
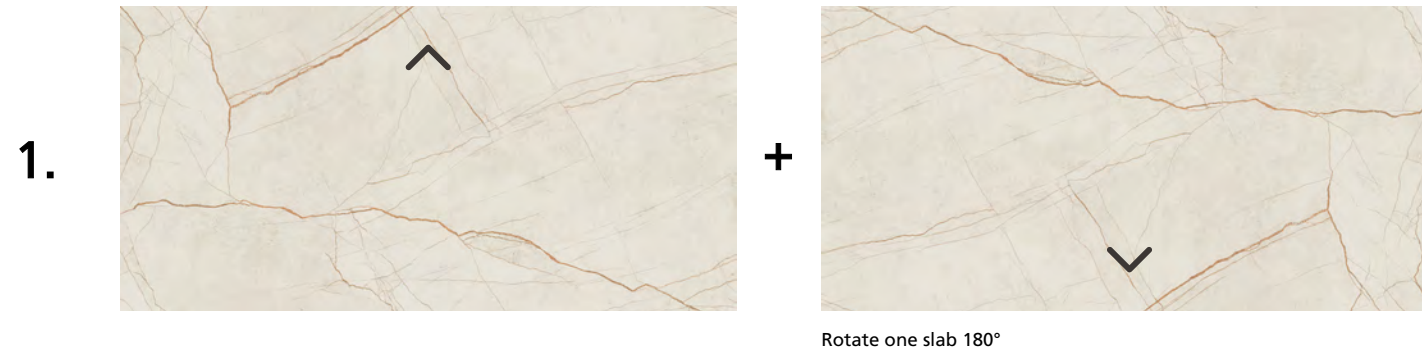

508 Isobellia | End result

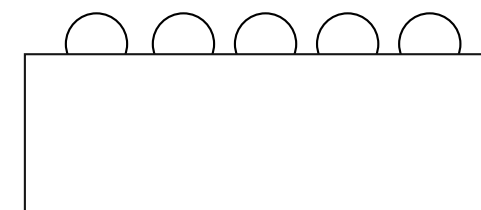

# 508 Isobellia | Pattern continuity plan

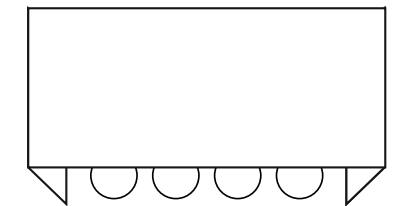
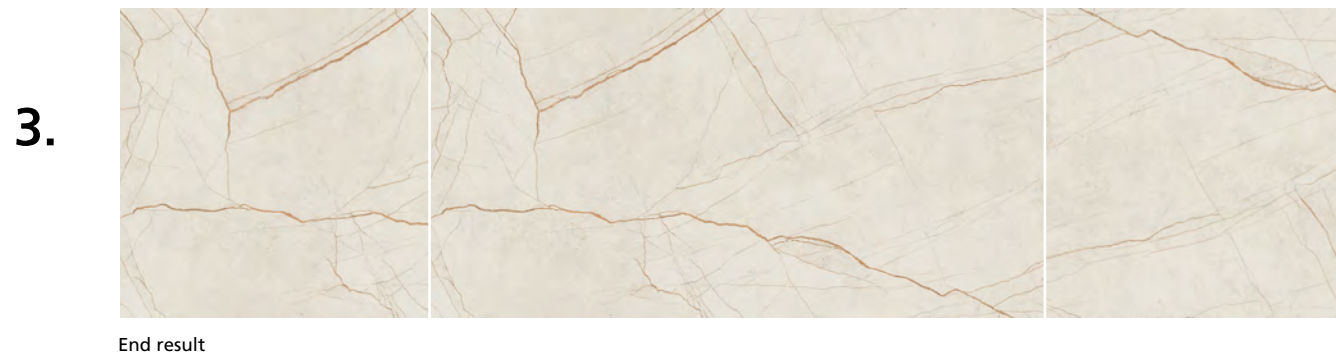

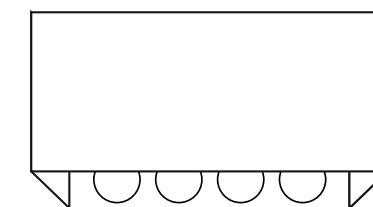
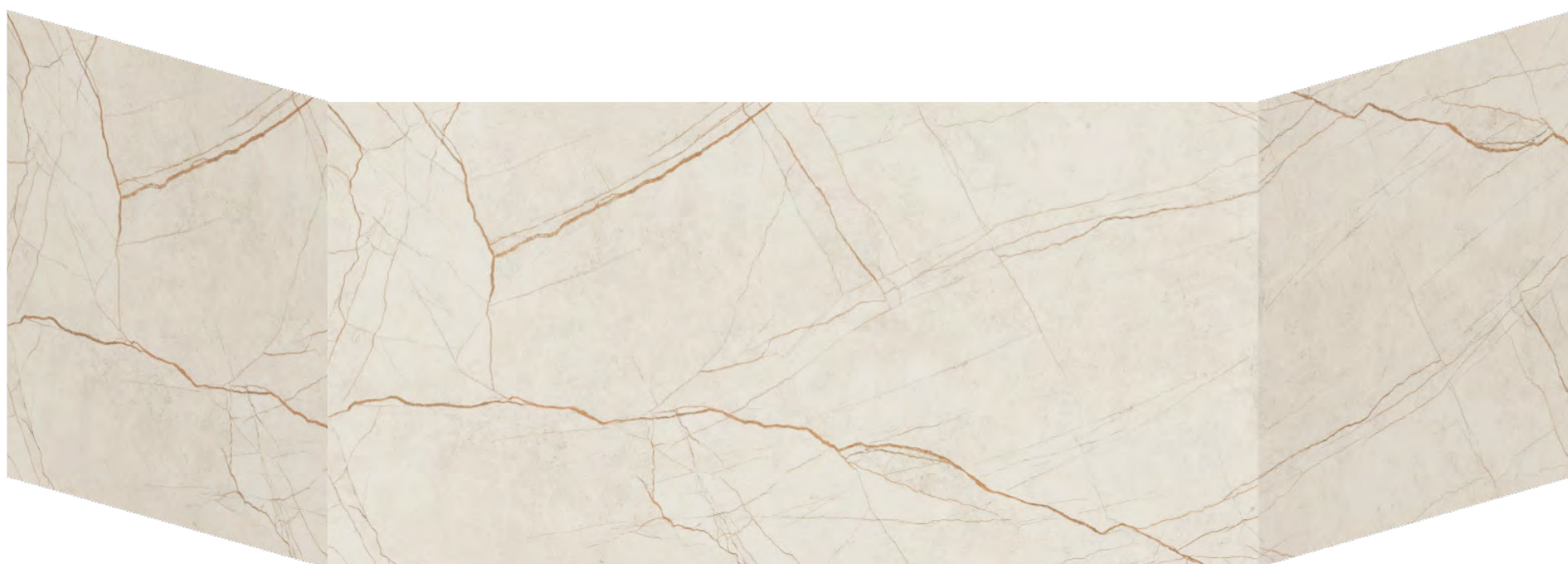

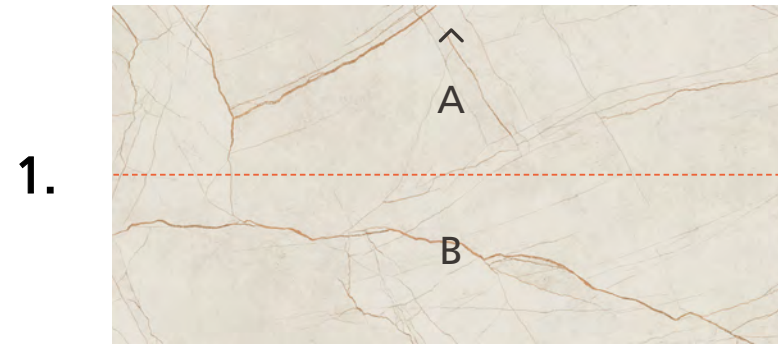

Cut the slab lengthwise

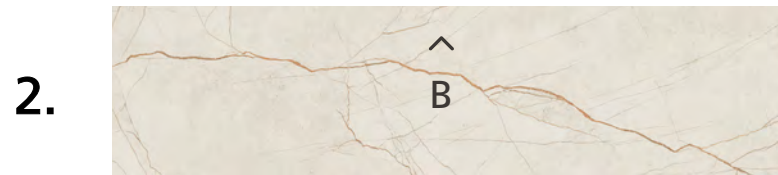

Rotate part A 180° and join parts A & B

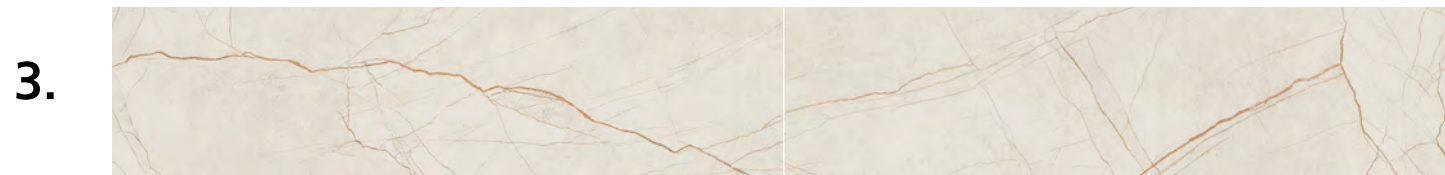
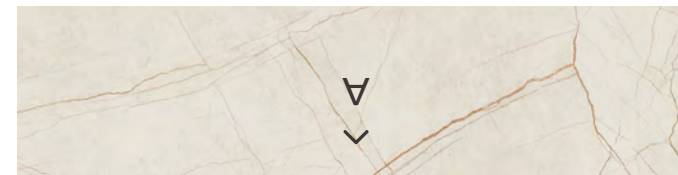

End result

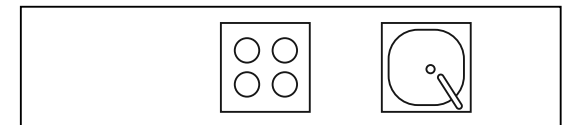

# 508 Isobellia | End result

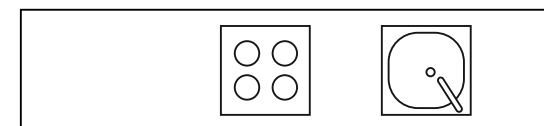
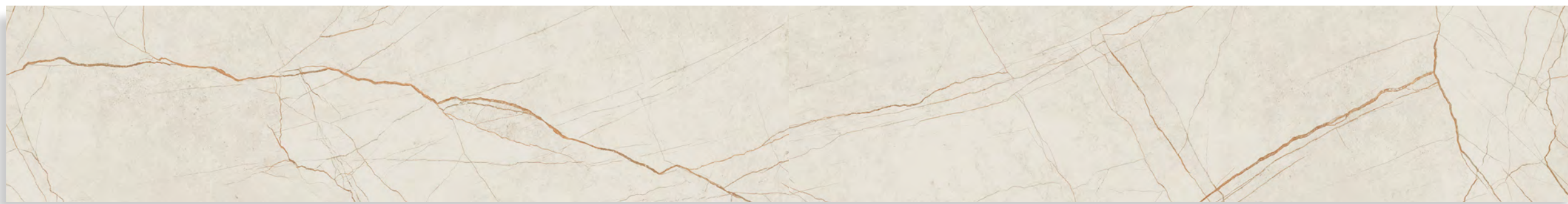

# 508 Isobellia | Pattern continuity L-shape

1.

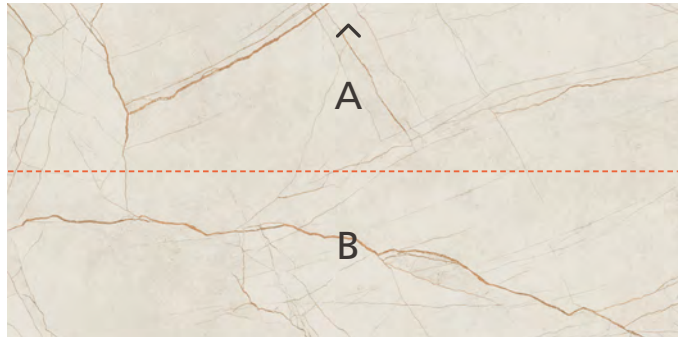

Cut the slab lengthwise

2.



Rotate part B 90° and join parts A & B

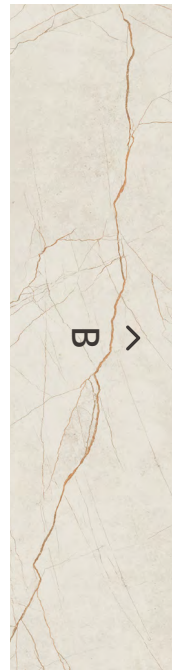

3.



End result

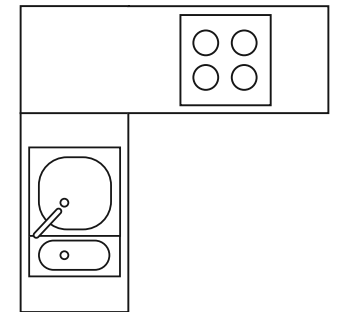
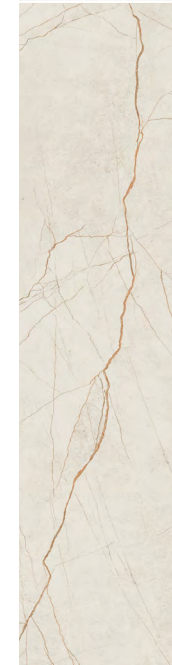

508 Isobellia | End result

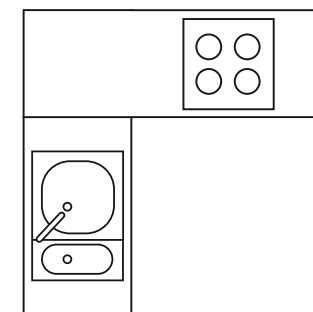

508 Isobellia | Pattern continuity countertop to backsplash

1.



Cut the slab lengthwise

2.

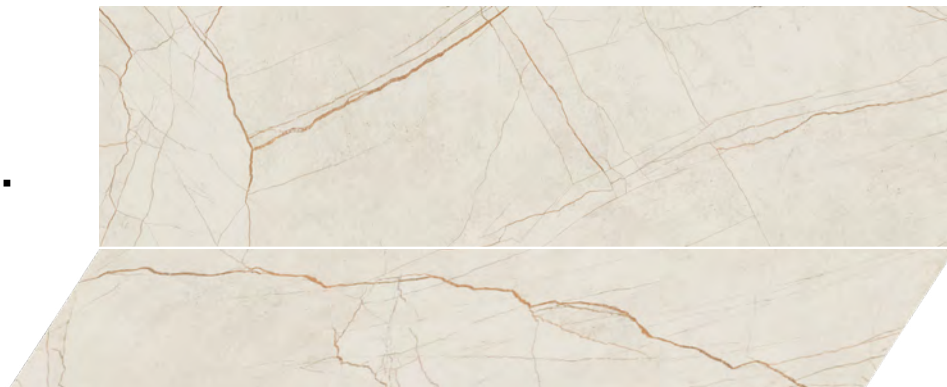

End result



# 508 Isobellia | End result

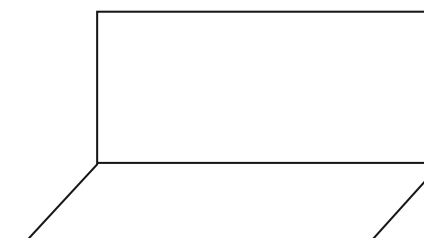
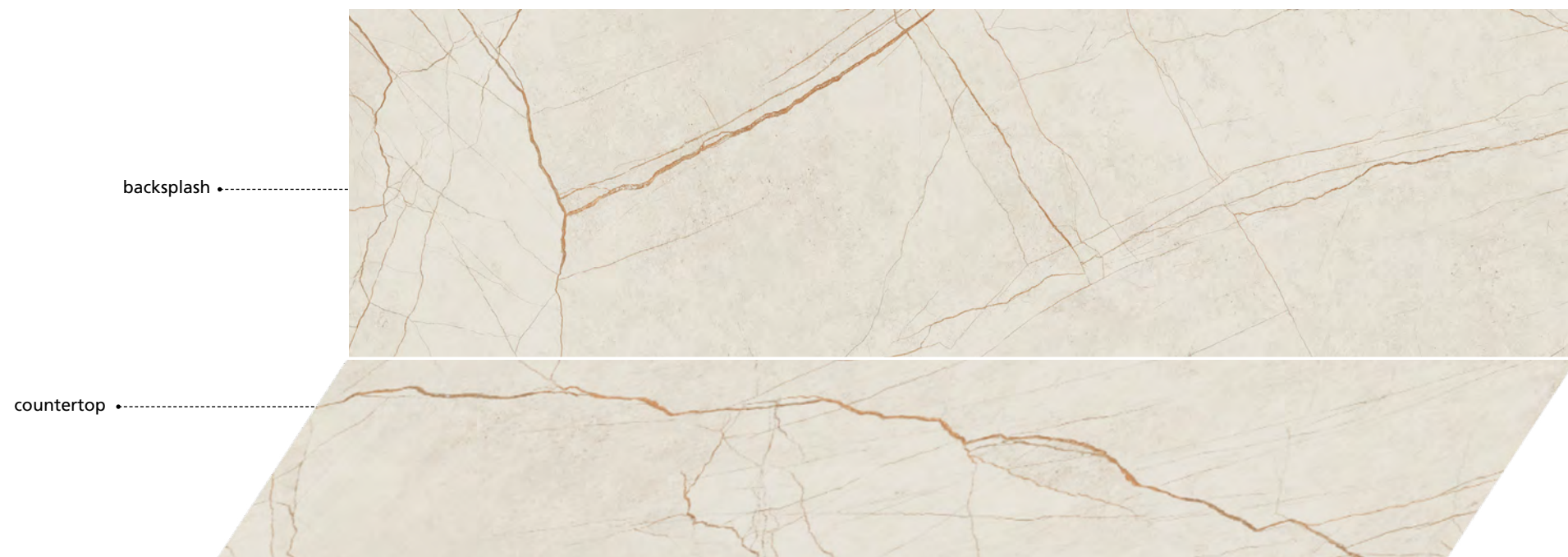

# 510 Impermia | Releasing slab tension

Full Slab



Reduce the 4 sides of the perimeter at a distance of 20-30 mm from the edges to release tension.

The useable slab size after releasing tension is 3160/3140 mm X 1560/1540 mm. (124<sup>3</sup>/<sub>8</sub>"/123<sup>5</sup>/<sub>8</sub>" X 61<sup>1</sup>/<sub>2</sub>"/60<sup>5</sup>/<sub>8</sub>" )

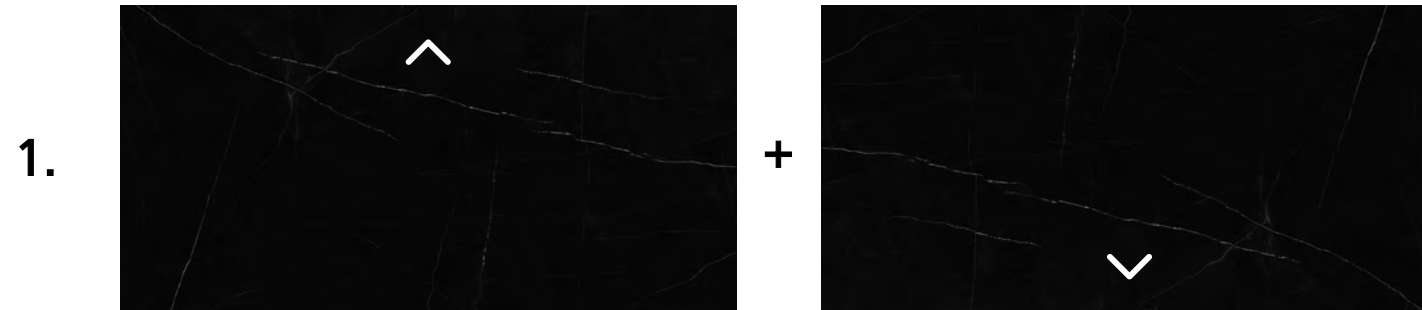

Rotate one slab 180°

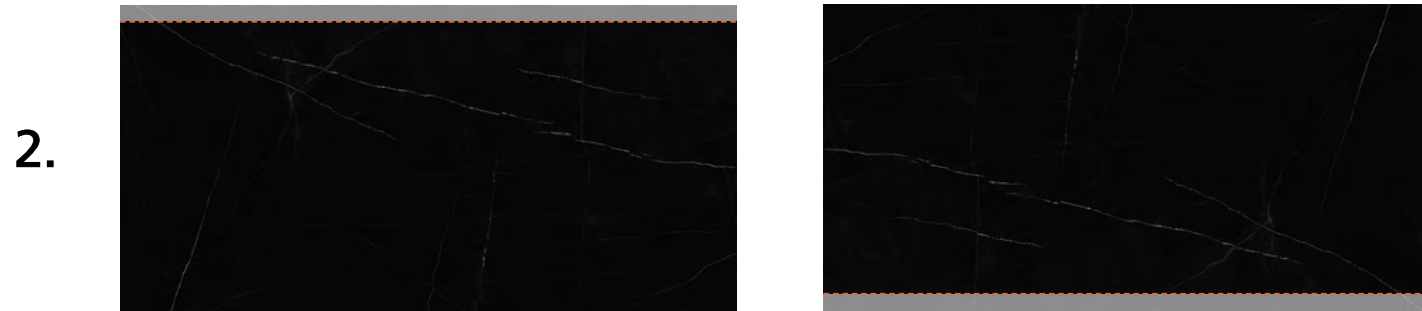

Plan to join the two slabs for continuation of the main veins and remove the surplus

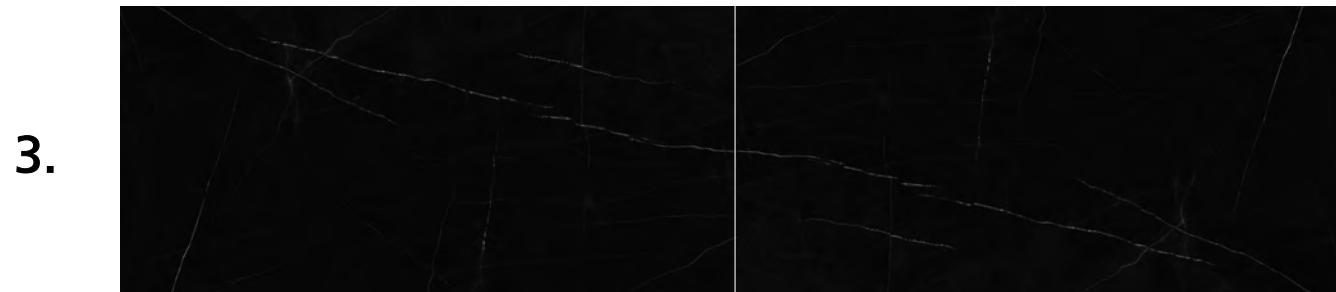

End result

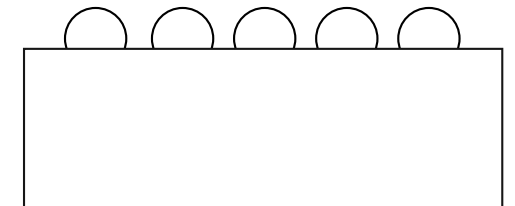

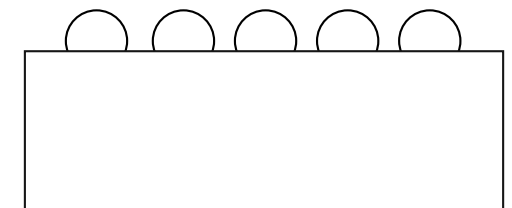

# 510 Impermia | Pattern continuity plan

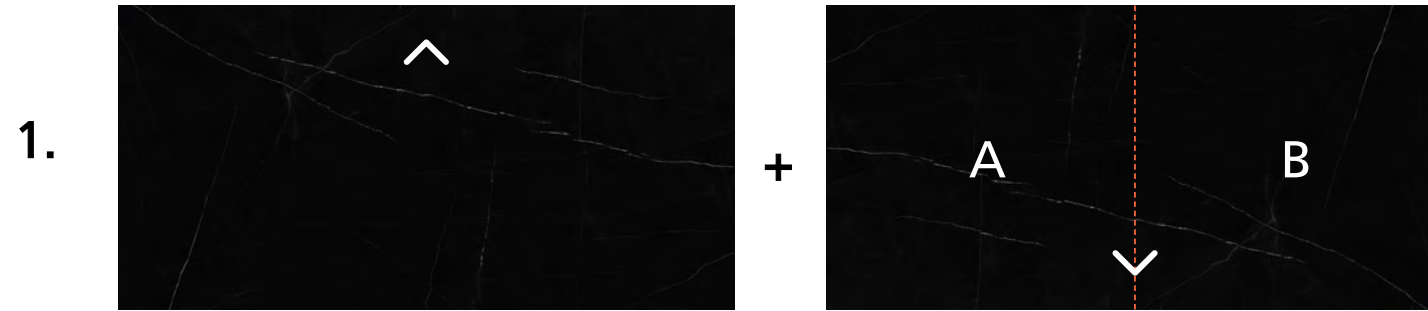

Rotate one slab 180° and cut widthwise

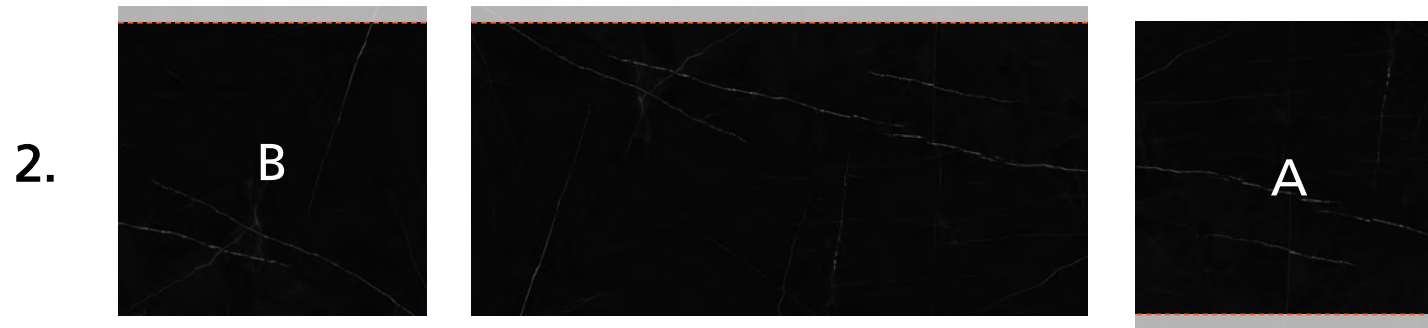

Plan to join parts A & B to the full slab for continuation of the main vein and remove the surplus

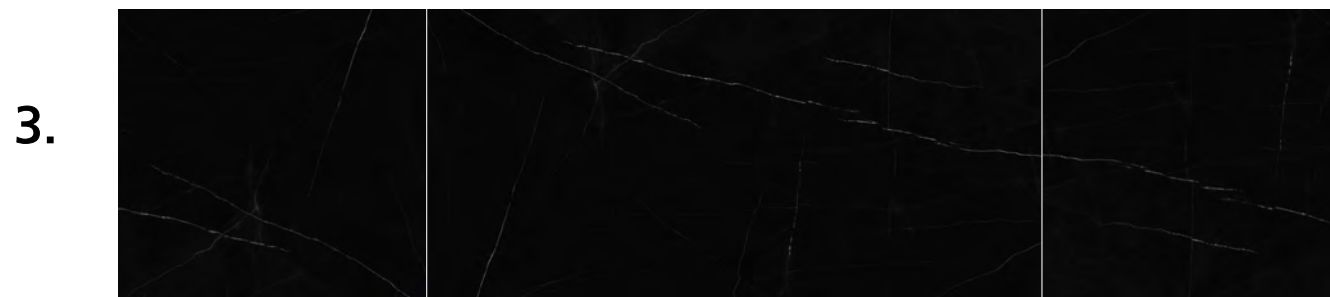

End result

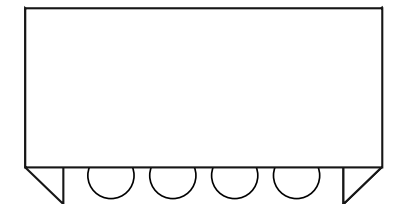

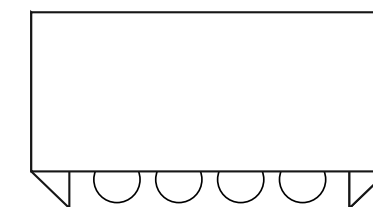

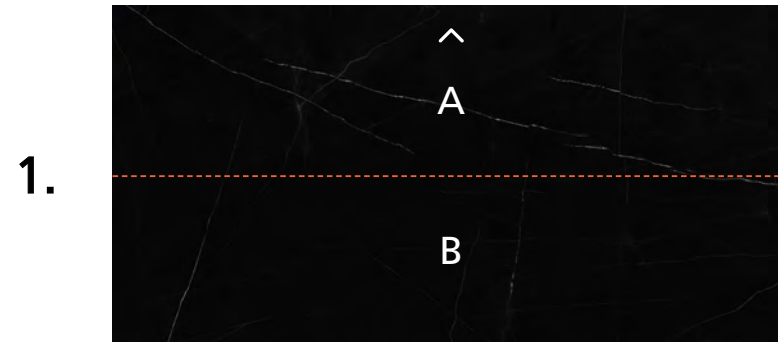

Cut the slab lengthwise



Join parts A & B

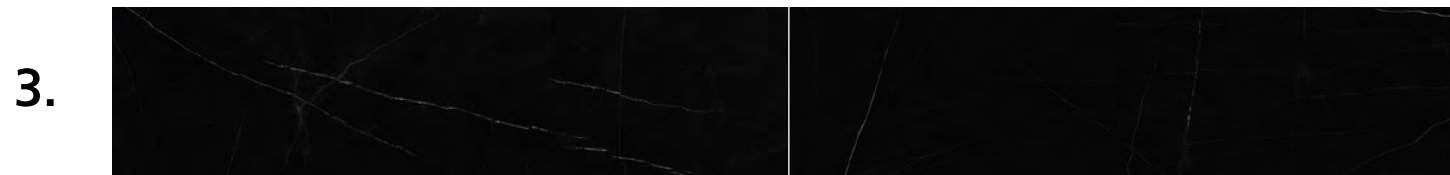
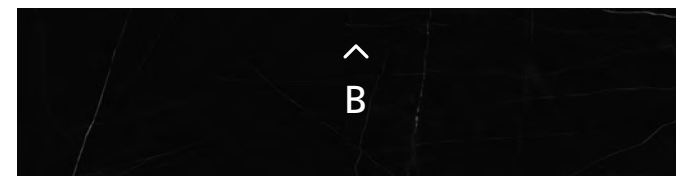

End result

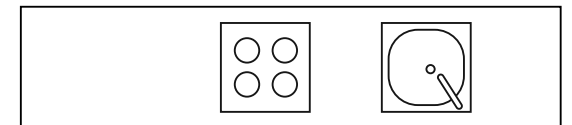

510 Impermia | End result

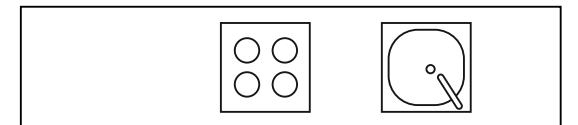

1.

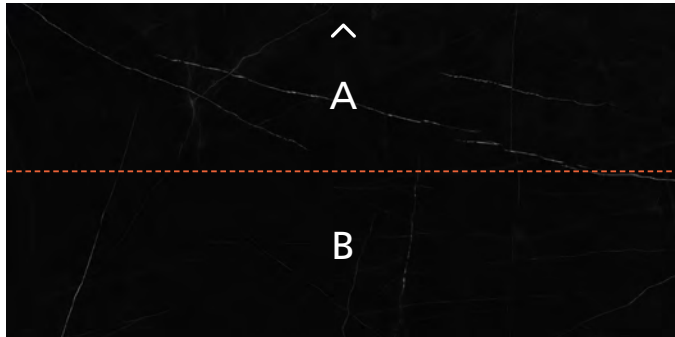

Cut the slab lengthwise

2.

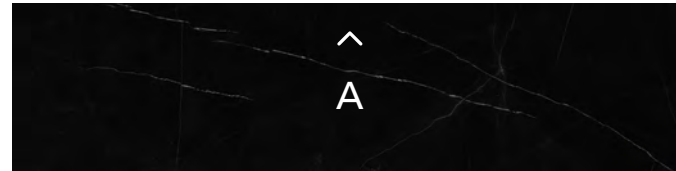

Rotate part B 90° and join parts A & B

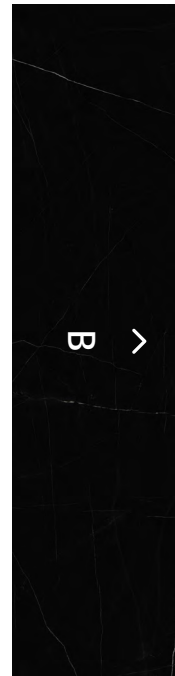

3.



End result

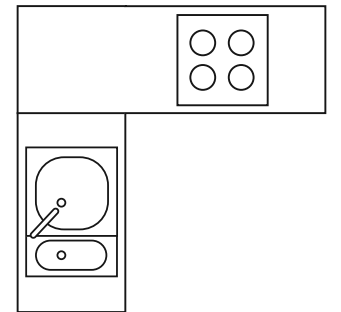

510 Impermia | End result

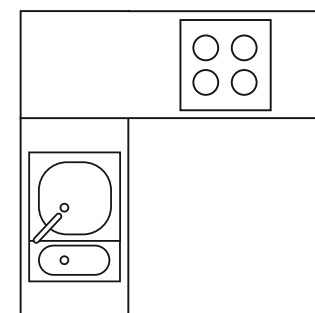
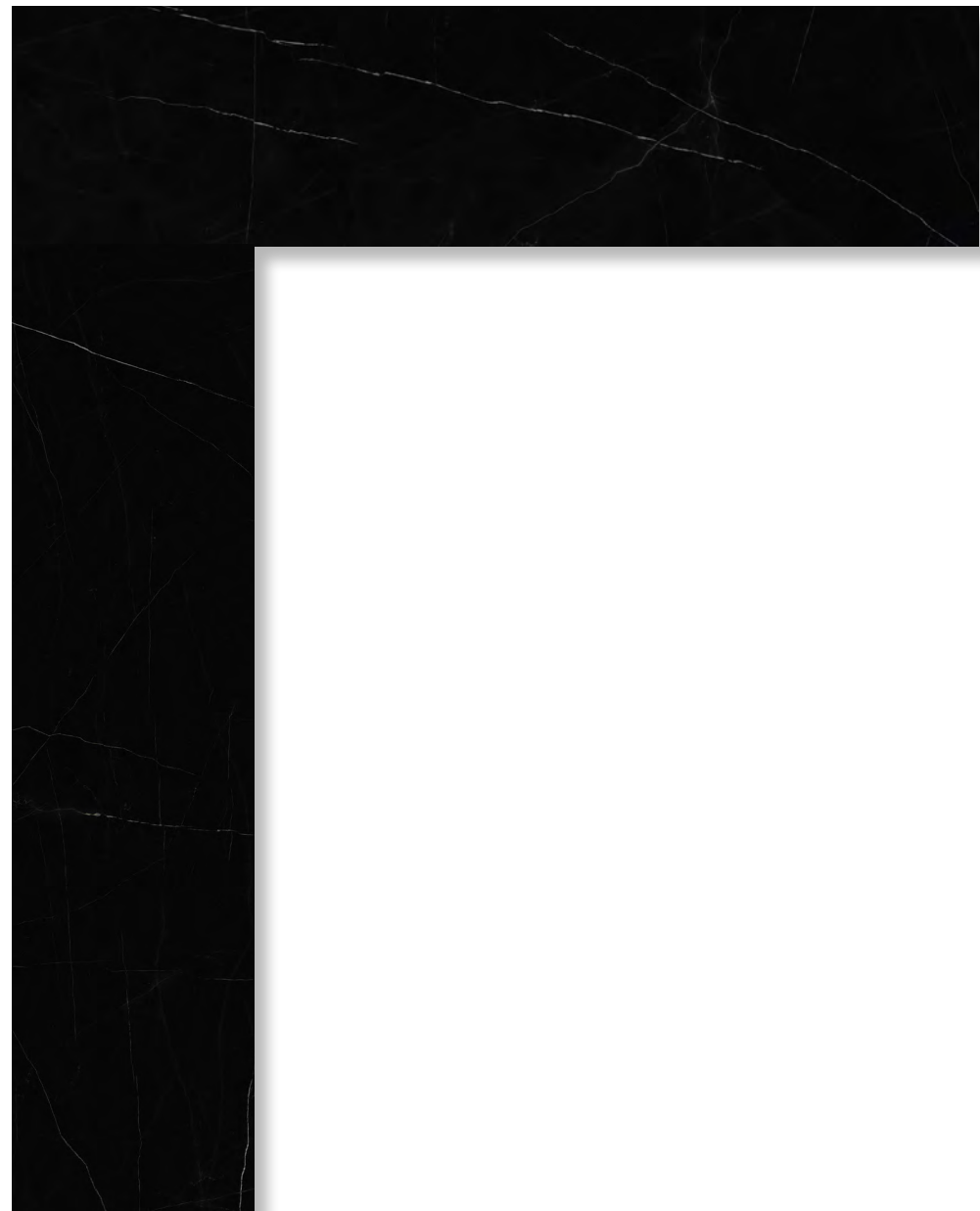

# 510 Impermia | Pattern continuity countertop to backsplash

1.

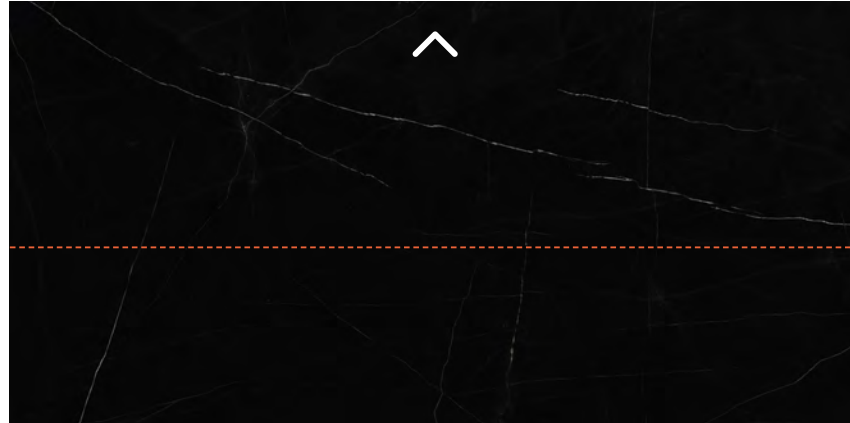

Cut the slab lengthwise

2.

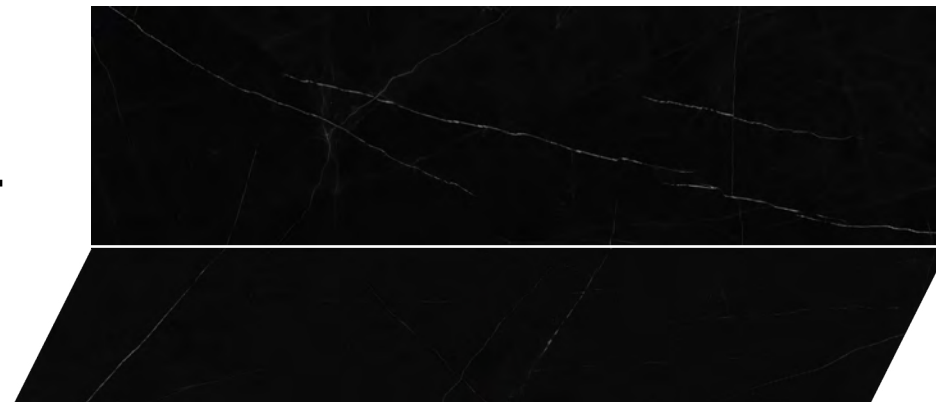

End result



# 510 Impermia | End result

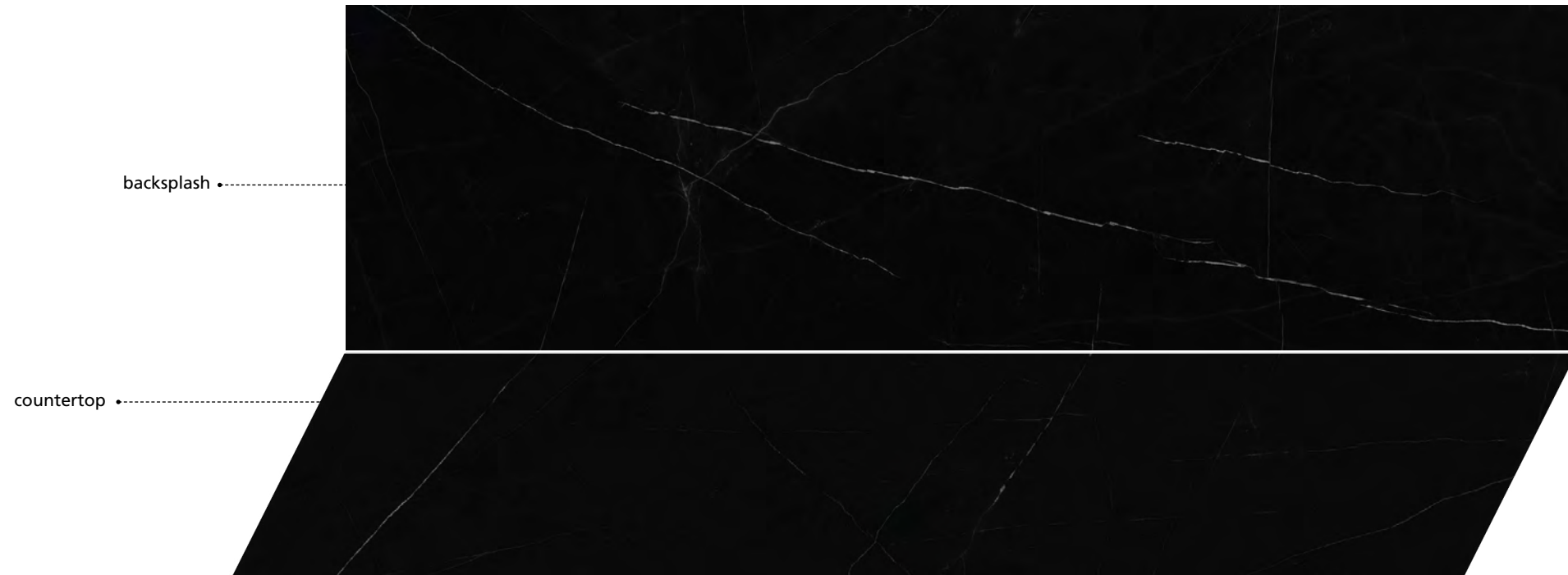

# 511 Smokestone | Releasing slab tension

Full Slab



Reduce the 4 sides of the perimeter at a distance of 20-30 mm from the edges to release tension.

The useable slab size after releasing tension is 3160/3140 mm X 1560/1540 mm. (124<sup>3</sup>/<sub>8</sub>"/123<sup>5</sup>/<sub>8</sub>" X 61<sup>1</sup>/<sub>2</sub>"/60<sup>5</sup>/<sub>8</sub>" )

# 511 Smokestone | Pattern continuity plan

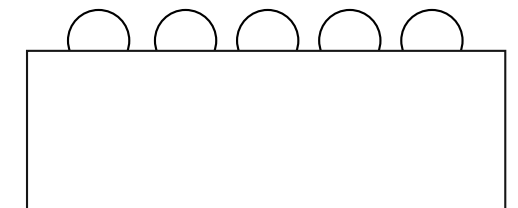
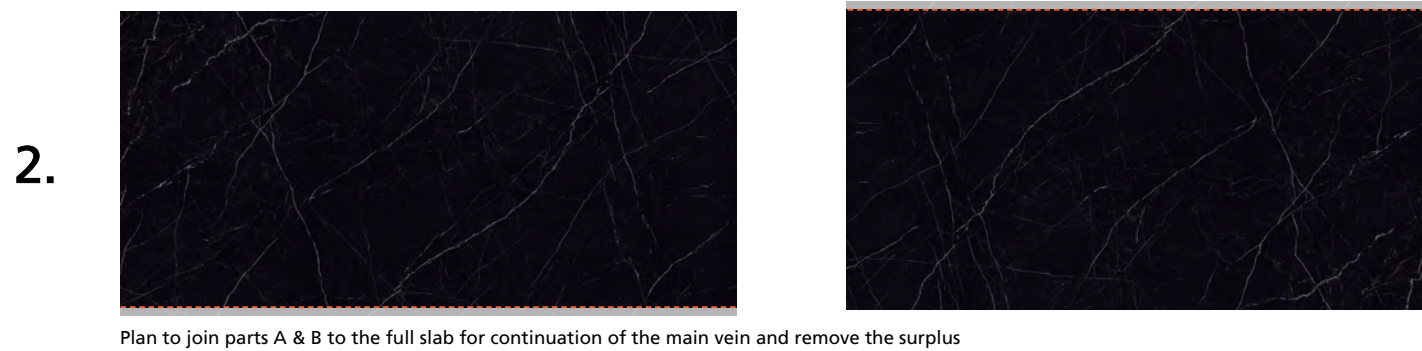

## 511 Smokestone | End result

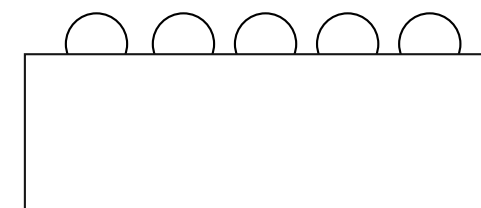
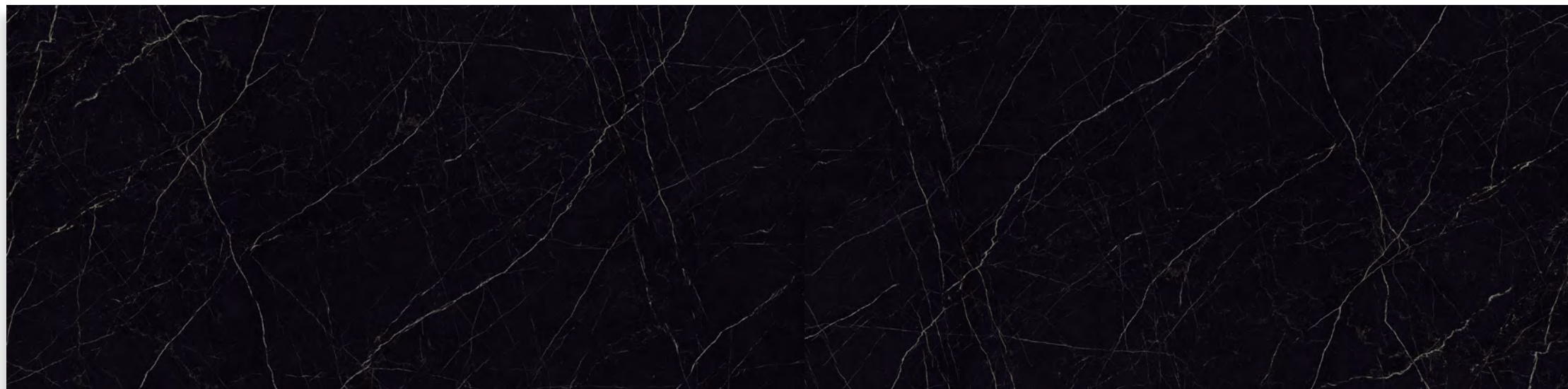

# 511 Smokestone | Pattern continuity plan

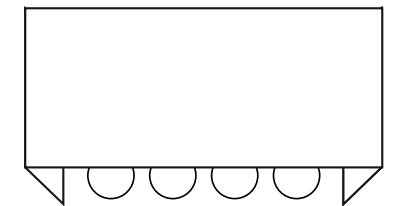
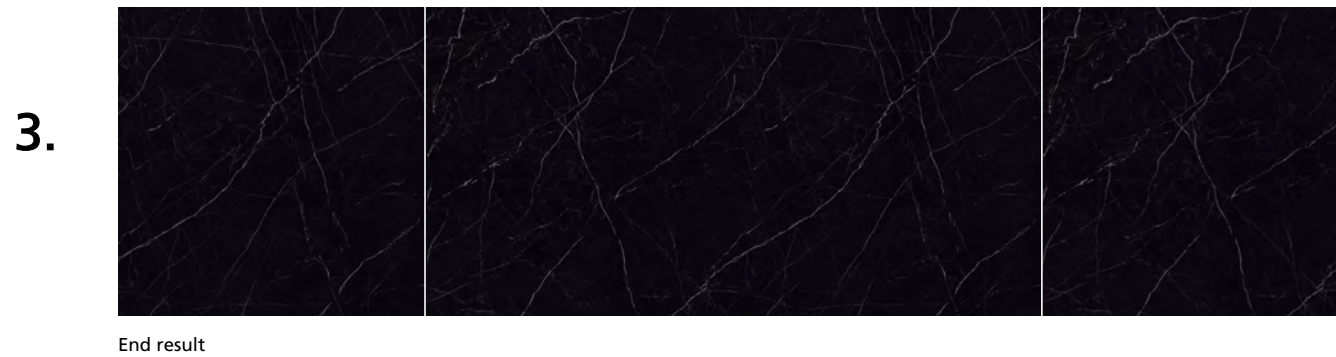
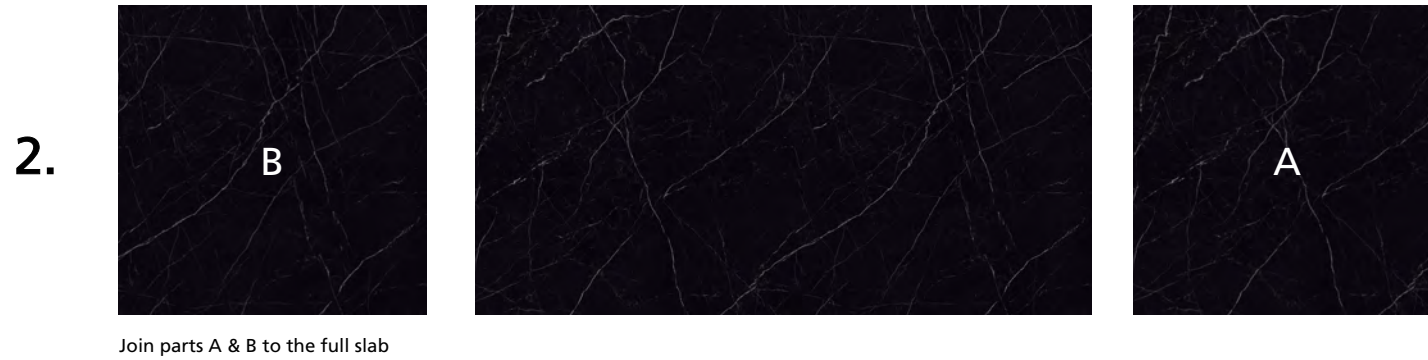

511 Smokestone | End result

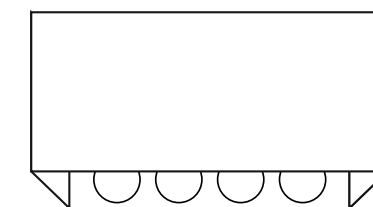
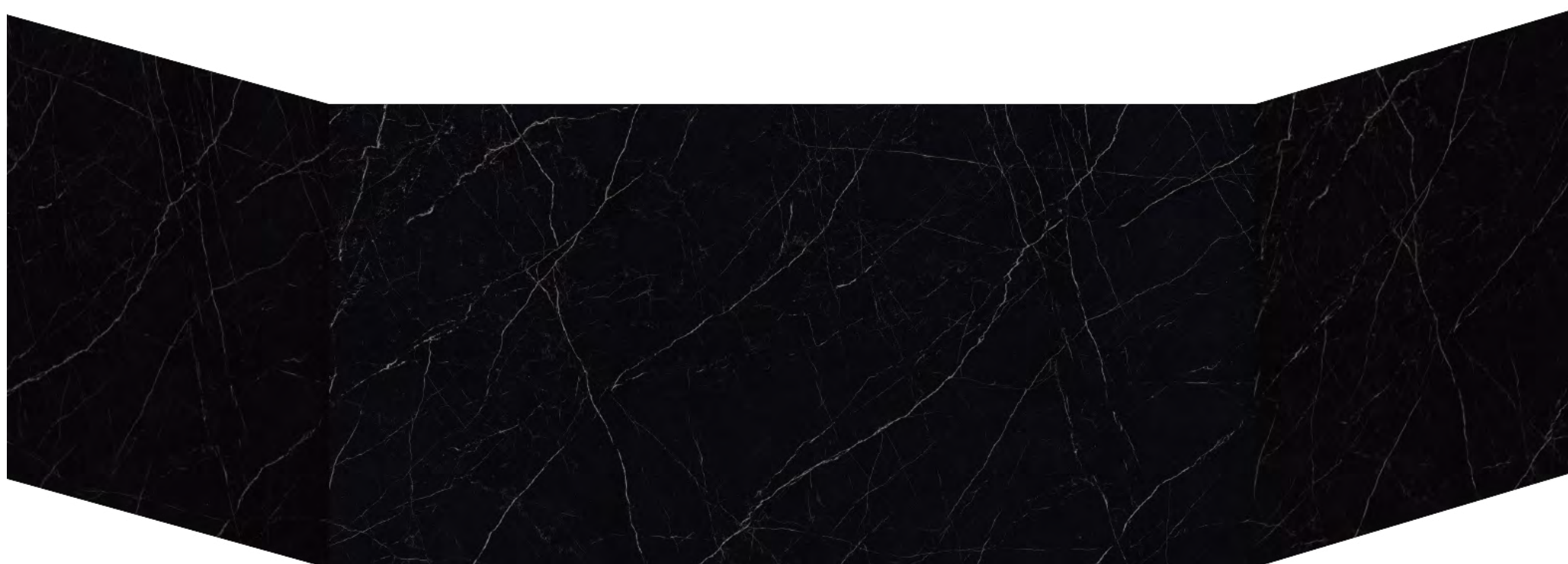

# 511 Smokestone | Pattern continuity plan

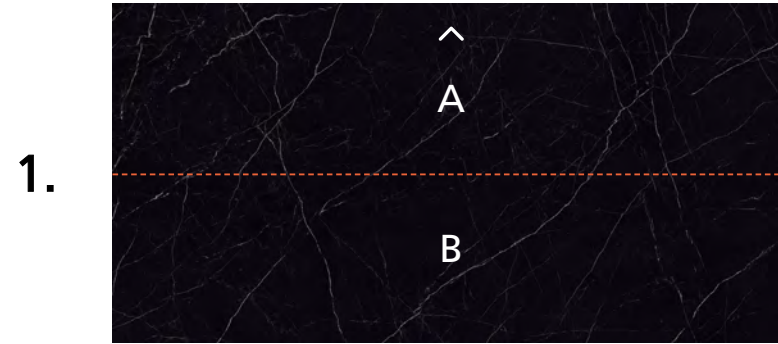

Cut the slab lengthwise

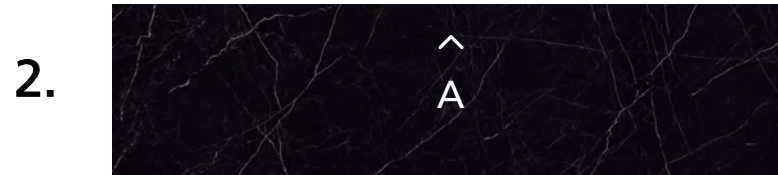

Join parts A & B

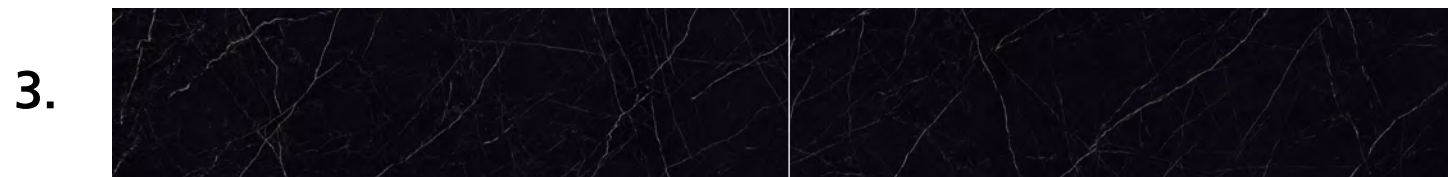
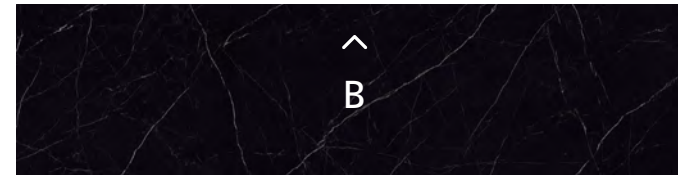

End result

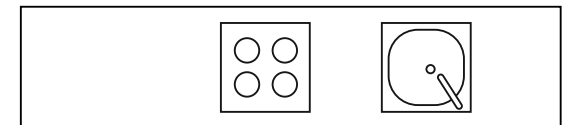

# 511 Smokestone | End result

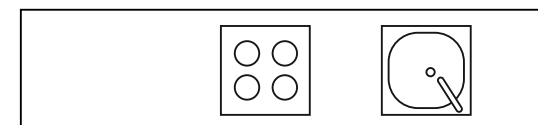
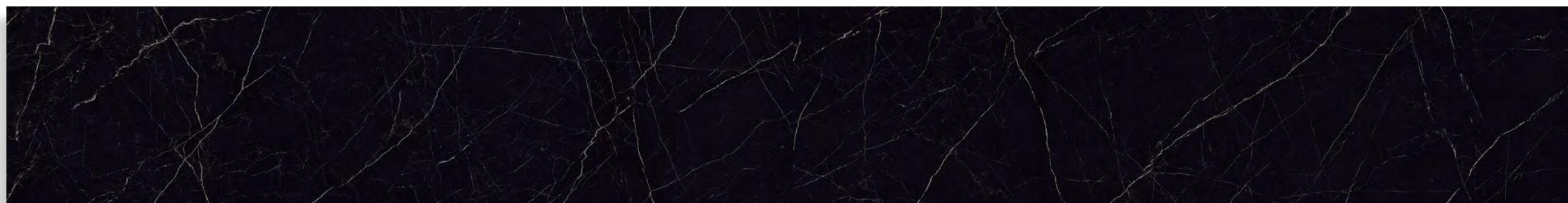

# 511 Smokestone | Pattern continuity L-shape

1.

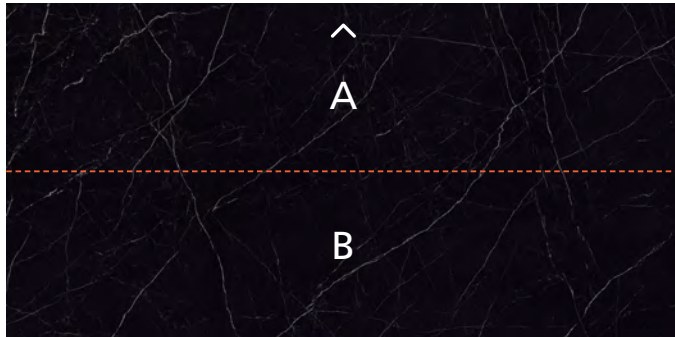

Cut the slab lengthwise

2.

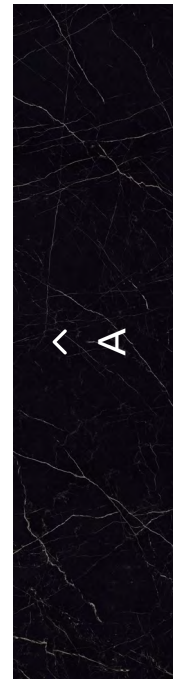

Rotate part A (90° and join parts A & B

3.

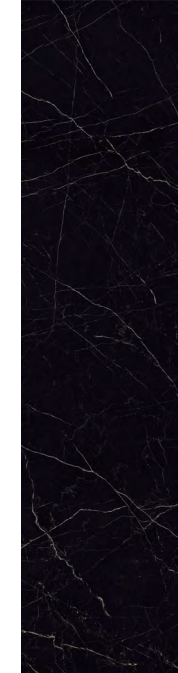
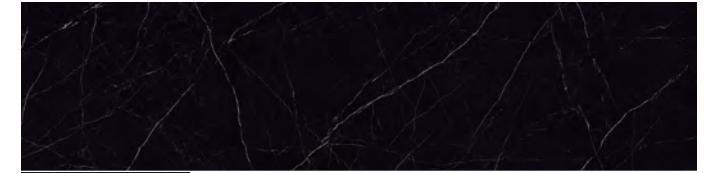

End result

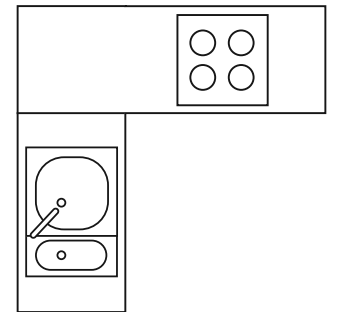

# 511 Smokestone | End result

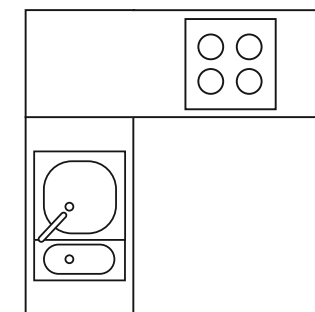
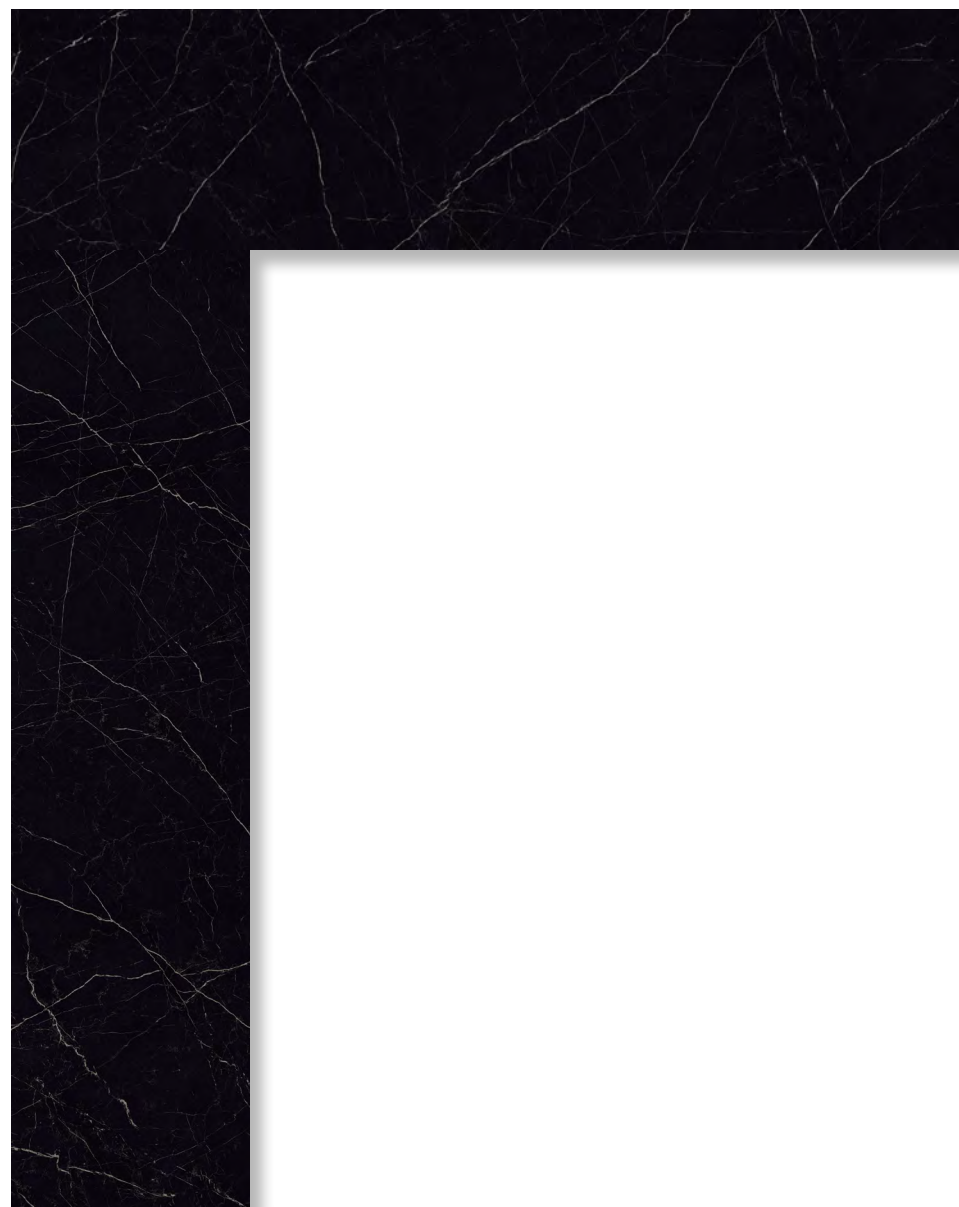

# 511 Smokestone | Pattern continuity countertop to backsplash

1.

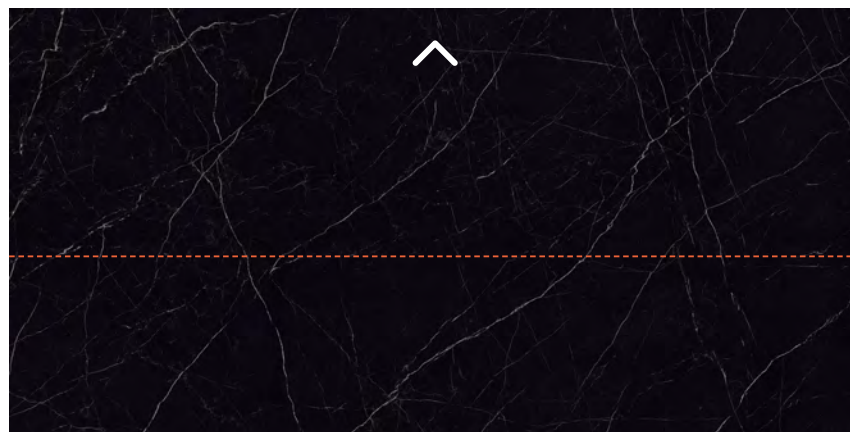

Cut the slab lengthwise

2.

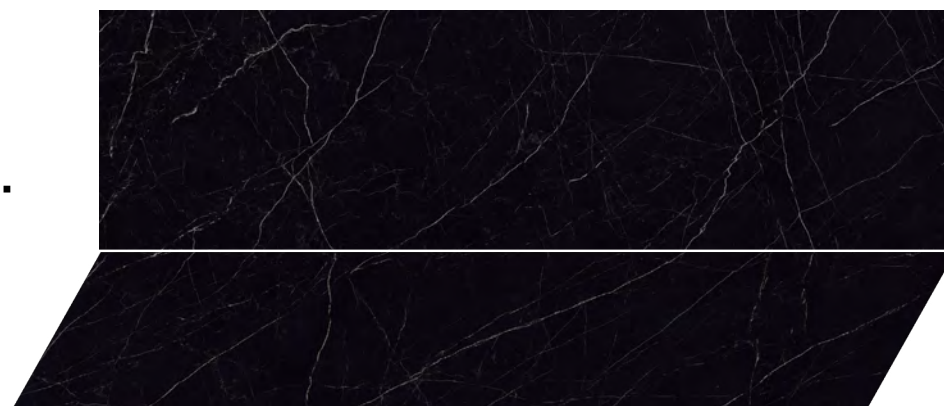

End result

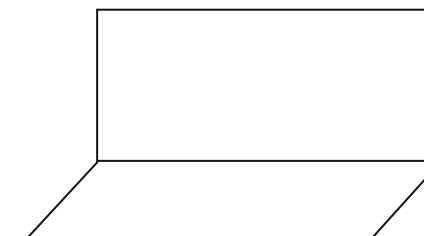

# 511 Smokestone | End result

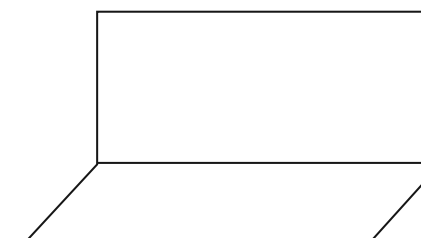
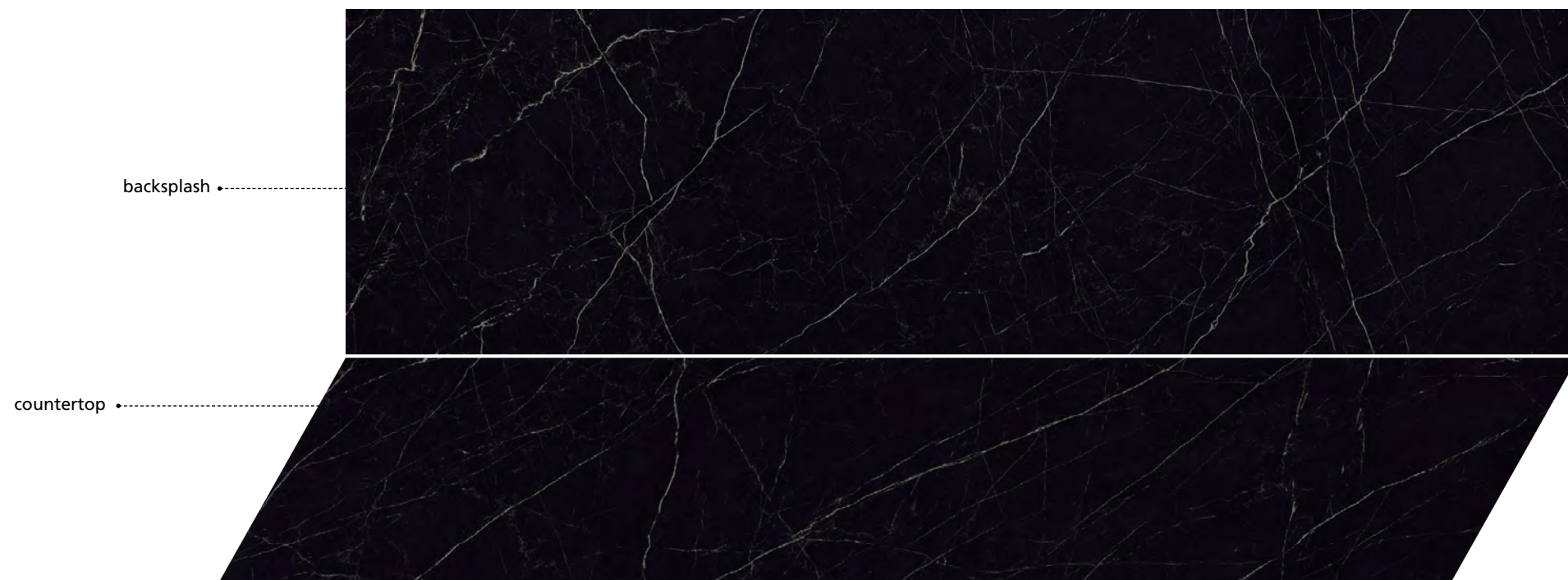

# 512 Transcenda | Releasing slab tension

Full Slab

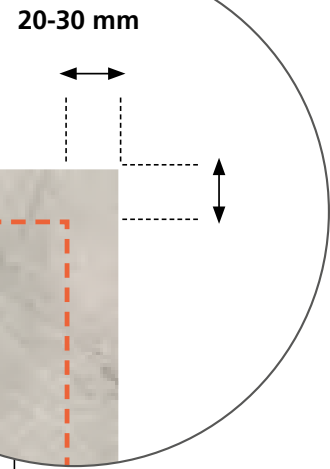
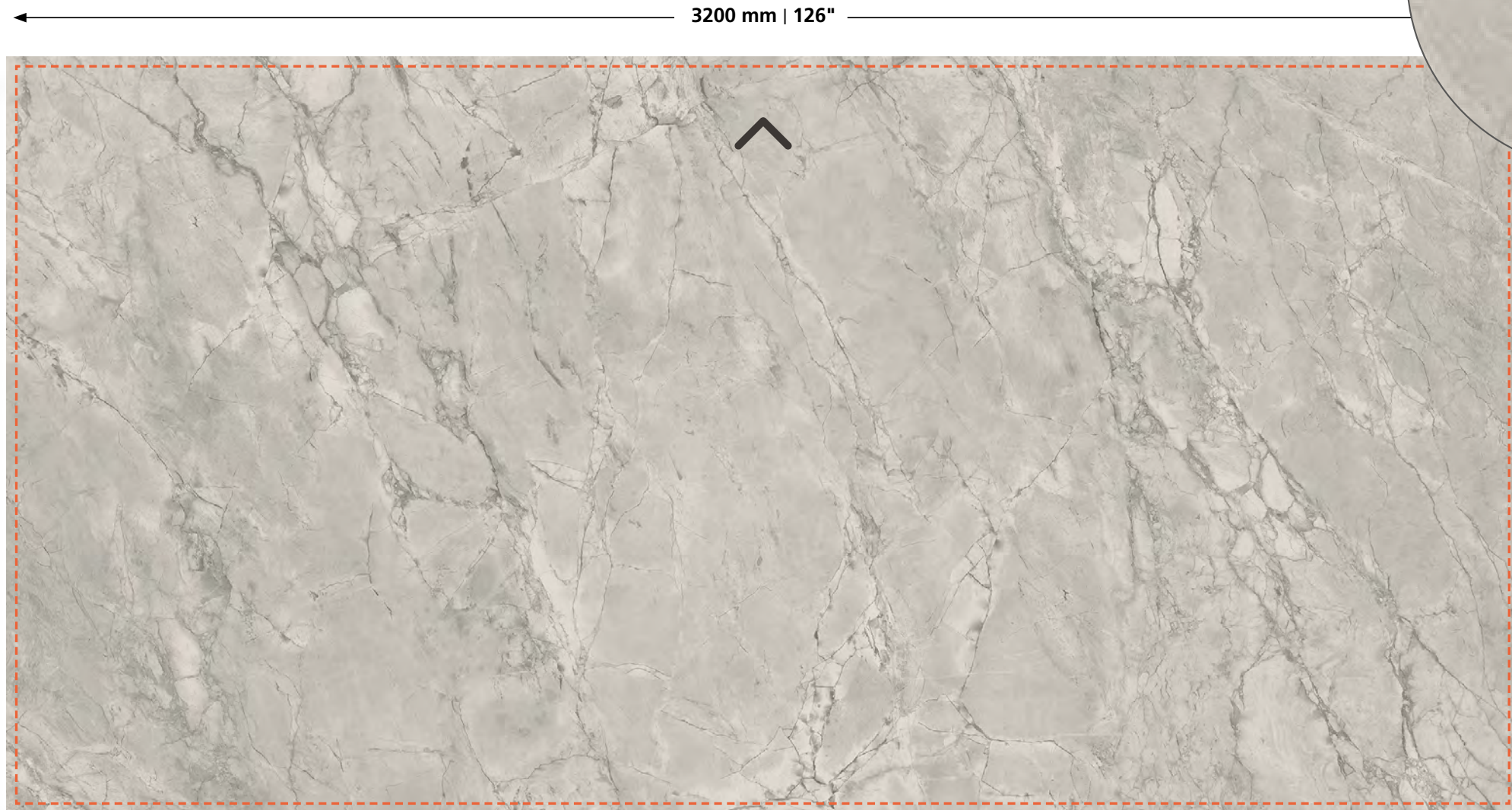

Reduce the 4 sides of the perimeter at a distance of 20-30 mm from the edges to release tension.

The useable slab size after releasing tension is 3160/3140 mm X 1560/1540 mm. (124<sup>3</sup>/<sub>8</sub>"/123<sup>5</sup>/<sub>8</sub>" X 61<sup>1</sup>/<sub>2</sub>"/60<sup>5</sup>/<sub>8</sub>" )

# 512 Transcenda | Pattern continuity plan



Plan to join the two slabs for pattern continuity and remove the surplus



End result

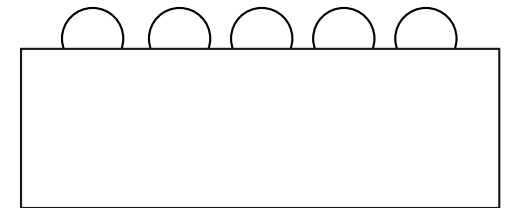

# 512 Transcenda | End result

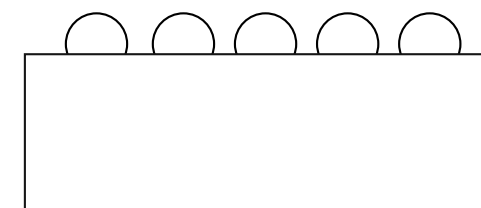

512 Transcenda | Pattern continuity plan

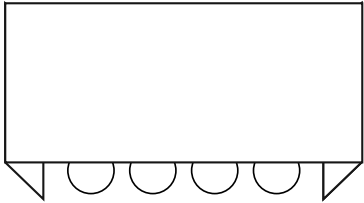

512 Transcenda | End result

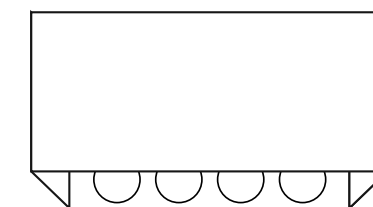
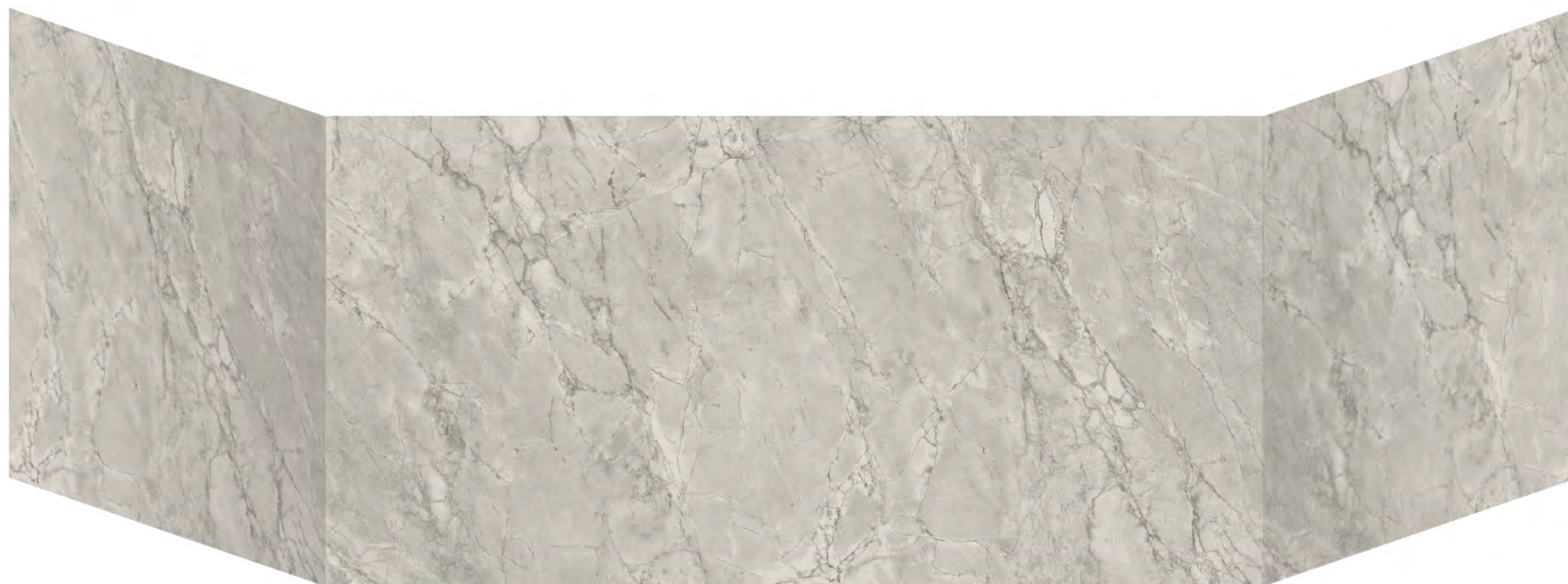

# 512 Transcenda | Pattern continuity plan

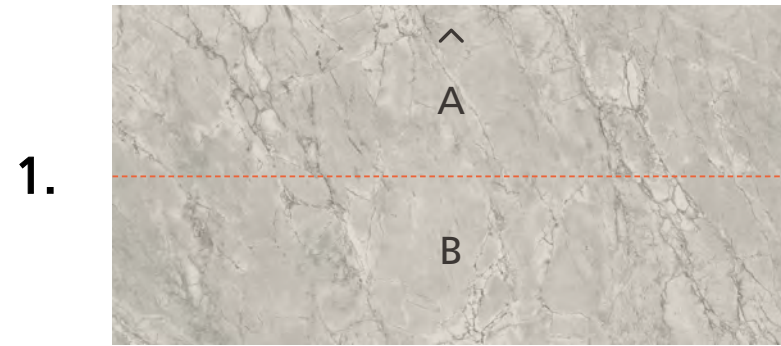

Cut the slab lengthwise

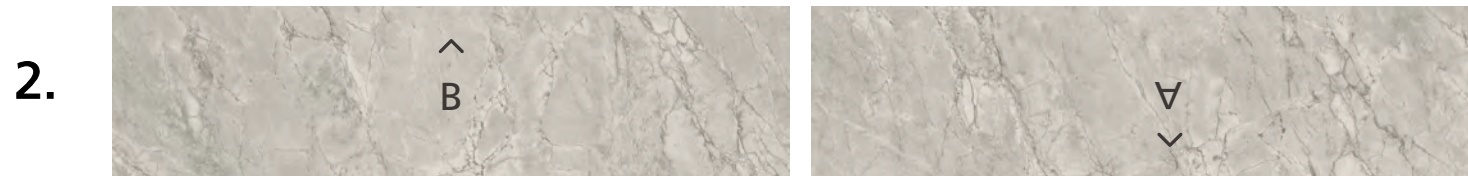

Rotate part A 180° and join parts A & B

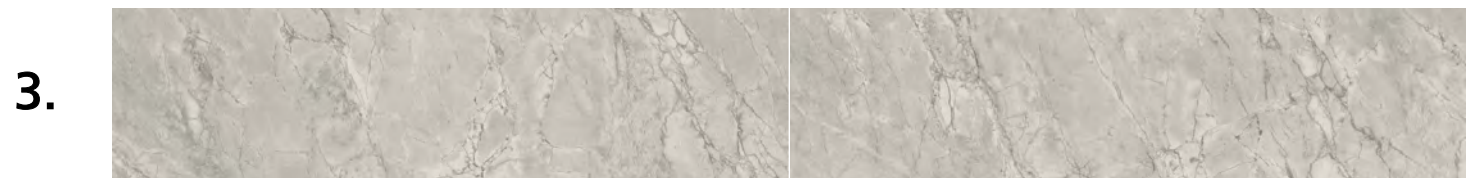

End result

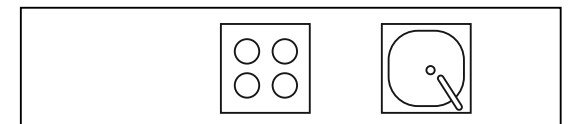

# 512 Transcenda | End result

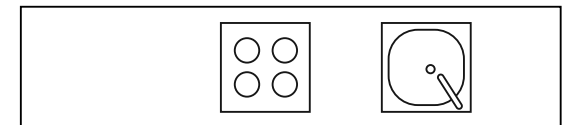

# 512 Transcenda | Pattern continuity L-shape

1.

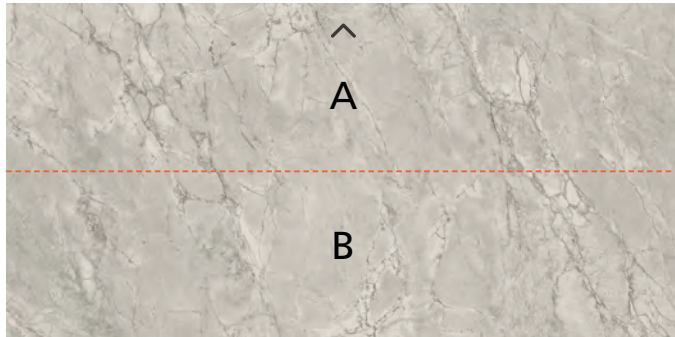

Cut the slab lengthwise

2.

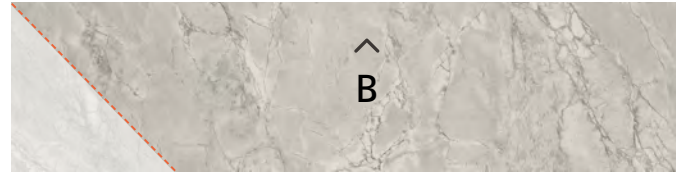

Rotate part A 90°. Plan to join parts A & B for pattern continuity and remove the surplus.



3.



End result

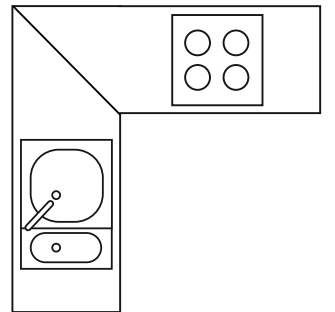

# 512 Transcenda | End result

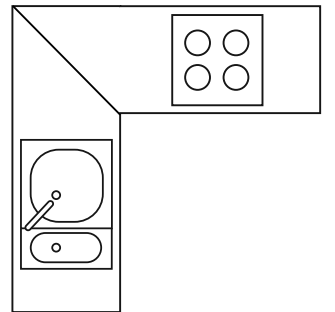

# 512 Transcenda | Pattern continuity countertop to backsplash

1.



Cut the slab lengthwise

2.

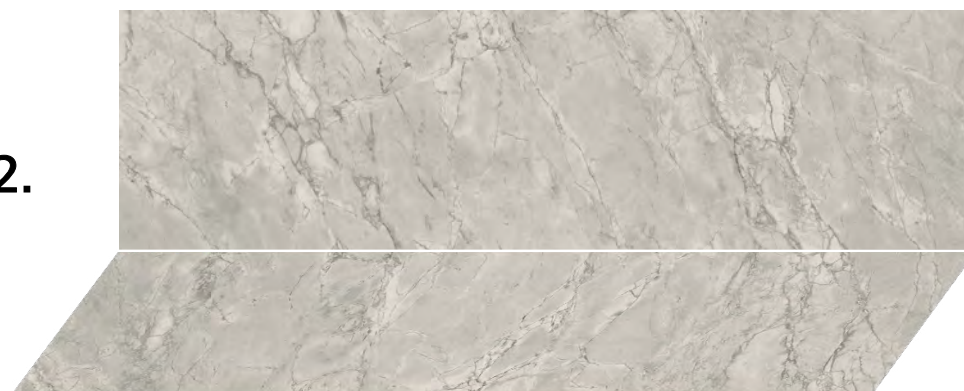

End result

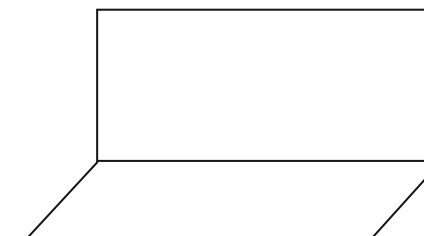

# 512 Transcenda | End result

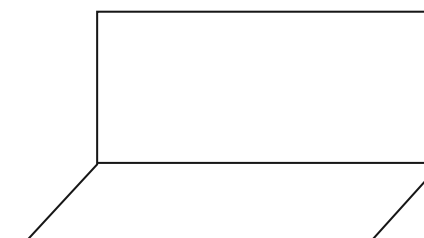

# 513 Striata | Releasing slab tension

Full Slab

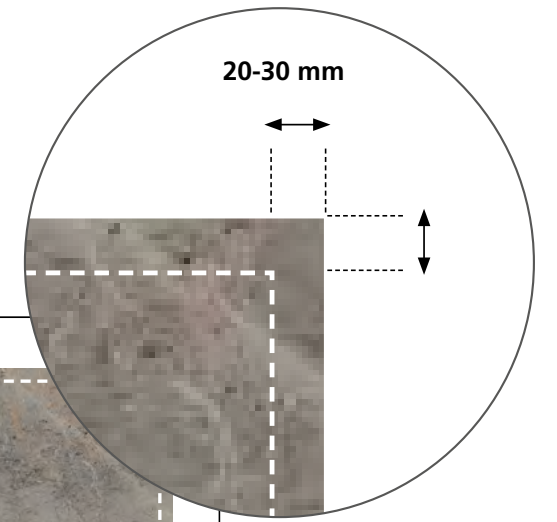
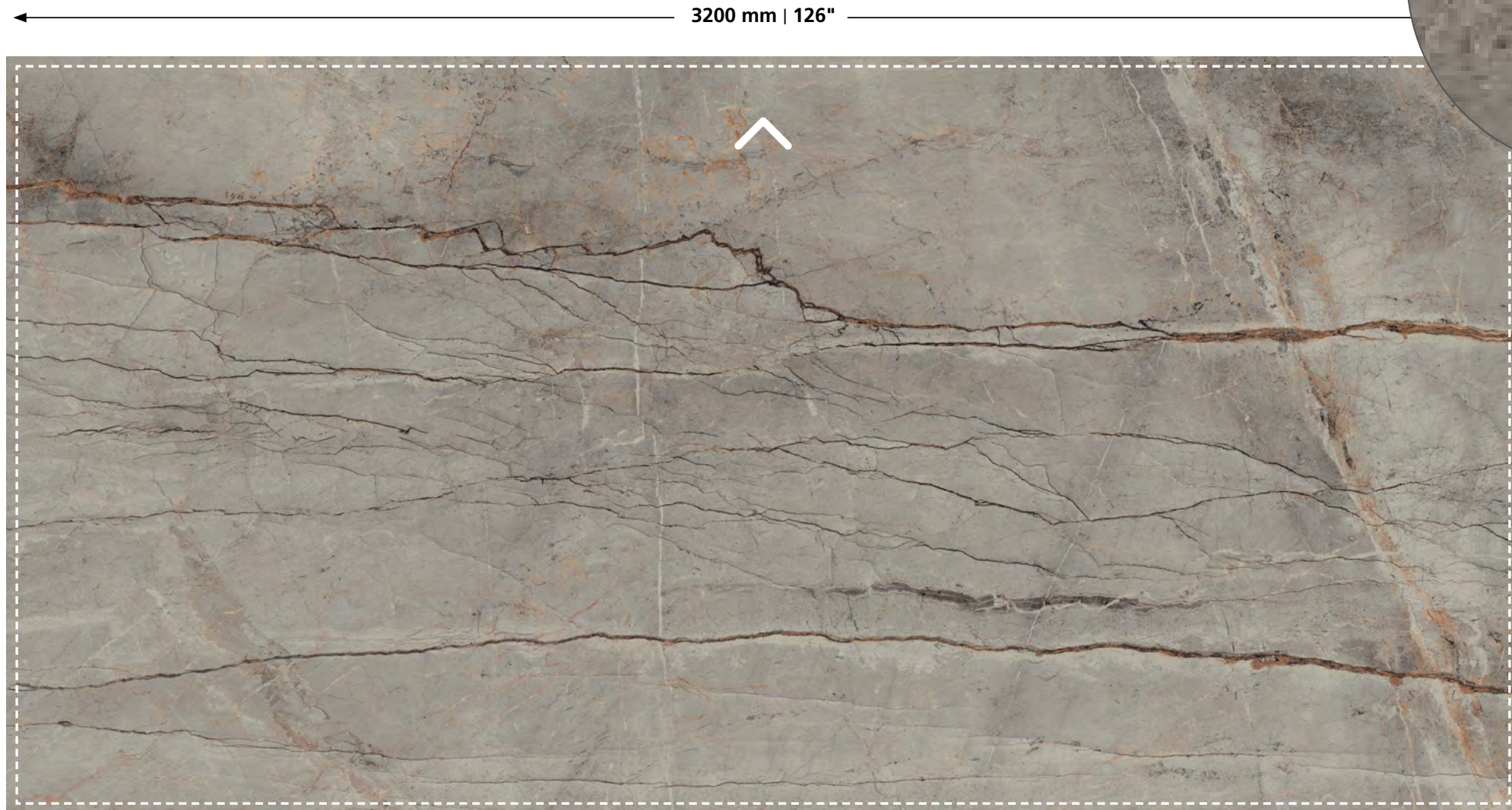

Reduce the 4 sides of the perimeter at a distance of 20-30 mm from the edges to release tension.

The useable slab size after releasing tension is 3160/3140 mm X 1560/1540 mm. (124<sup>3</sup>/<sub>8</sub>"/123<sup>5</sup>/<sub>8</sub>" X 61<sup>1</sup>/<sub>2</sub>"/60<sup>5</sup>/<sub>8</sub>" )

1600 mm | 63"

# 513 Striata | Pattern continuity plan

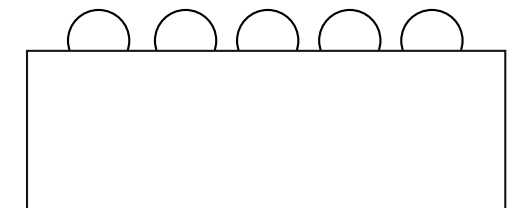
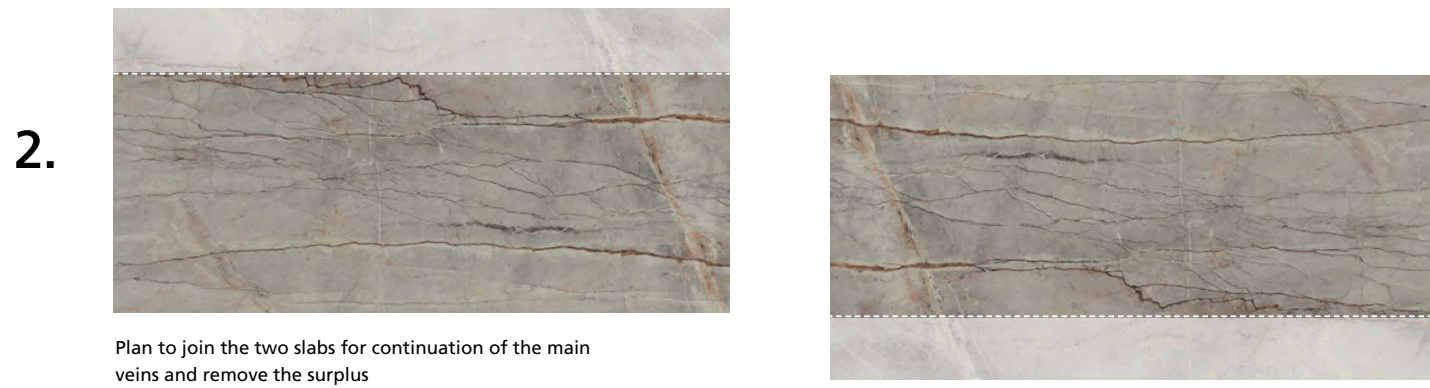
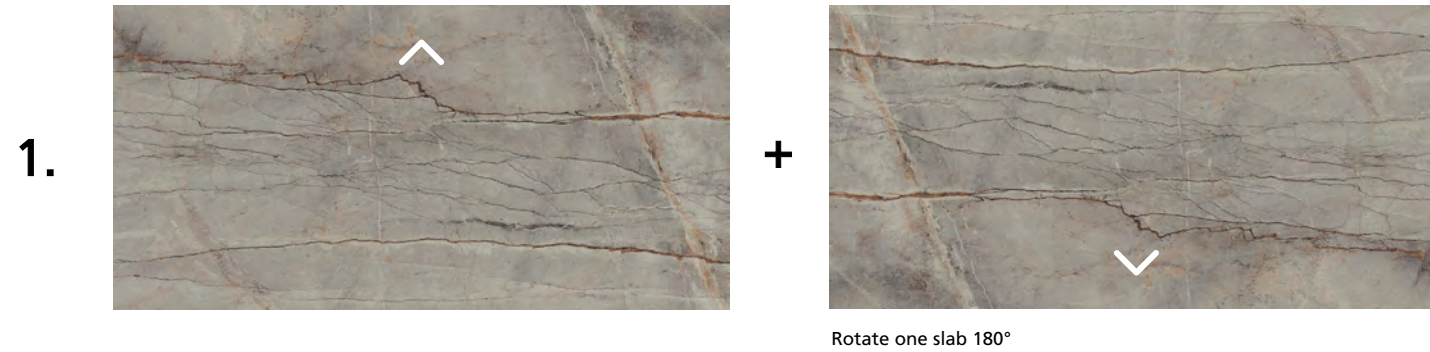

513 Striata | End result

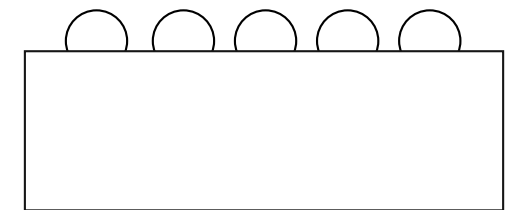

# 513 Striata | Pattern continuity plan

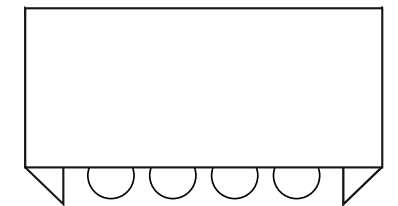

513 Striata | End result

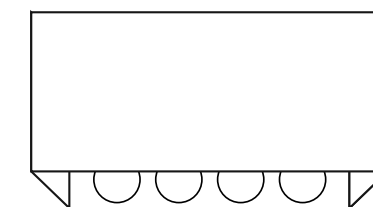

# 513 Striata | Pattern continuity plan

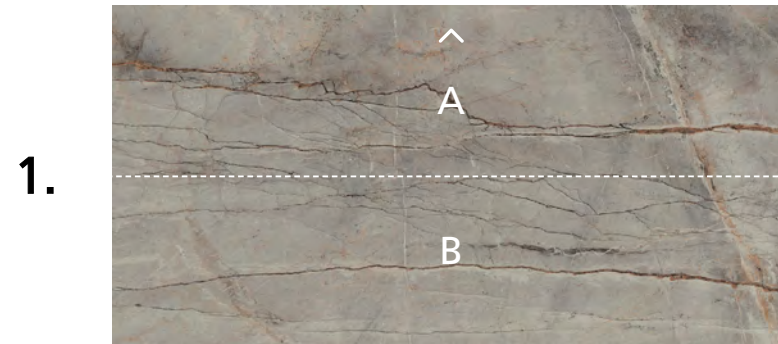

Cut the slab lengthwise



Rotate part A 180°. Plan to join parts A & B for continuation of the main vein and remove the surplus.

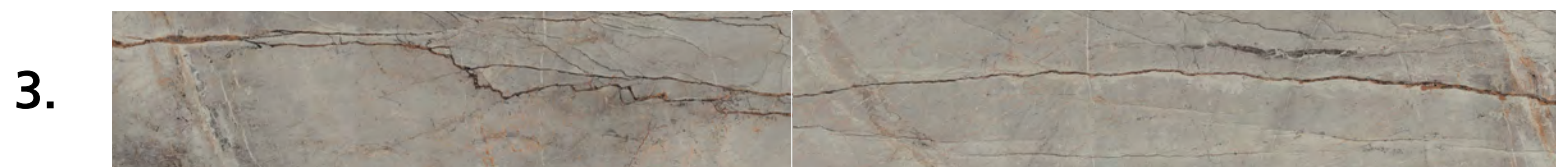
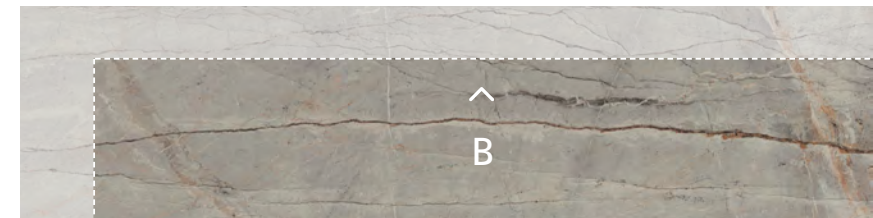

End result

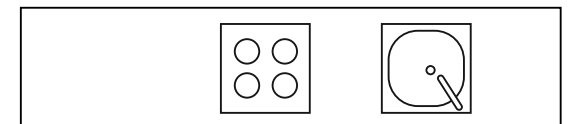

# 513 Striata | End result

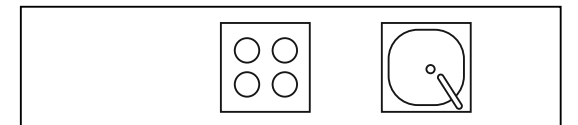
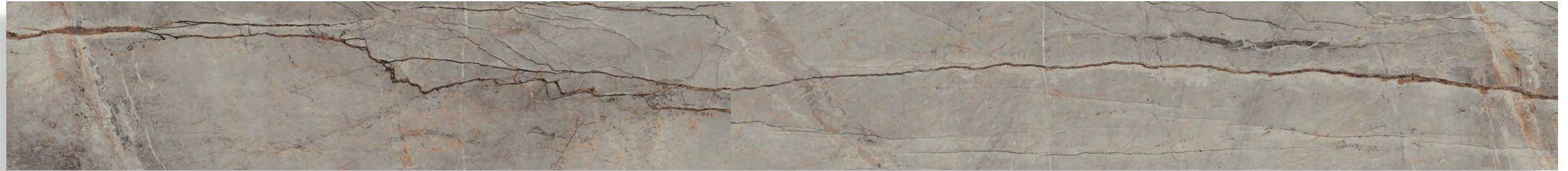

# 513 Striata | Pattern continuity L-shape

1.

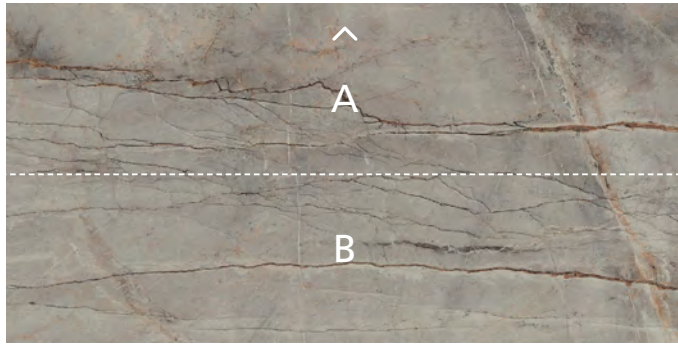

Cut the slab lengthwise

2.

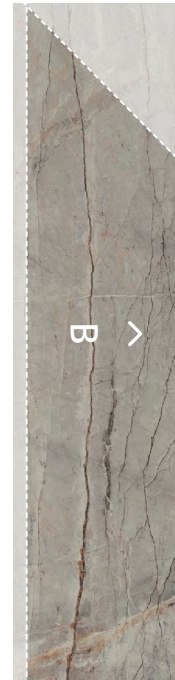

Rotate part A 180° and rotate part B 90°. Plan to join parts A & B for continuation of the main vein and remove the surplus.

3.

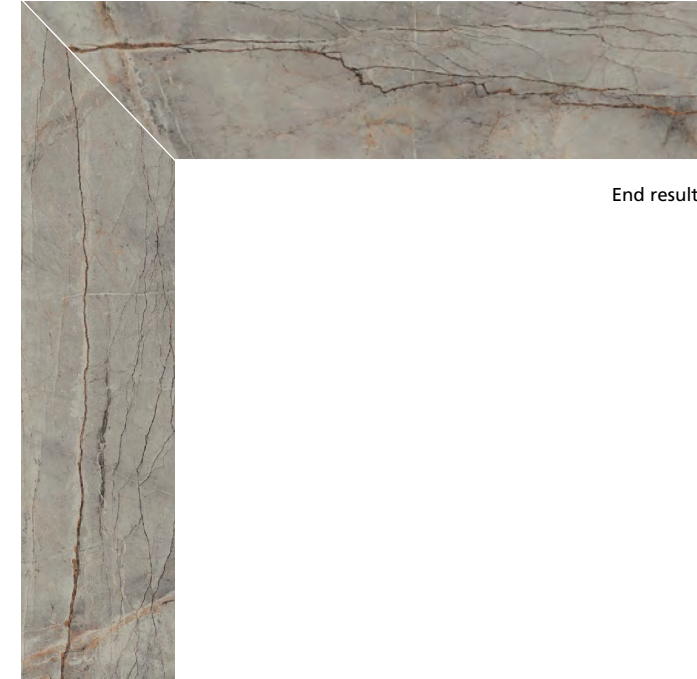

End result

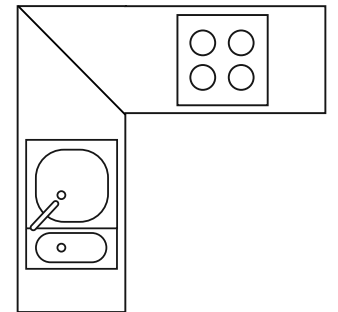

# 513 Striata | End result

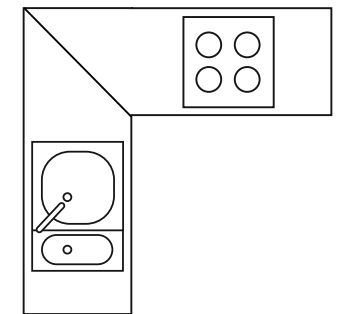

# 513 Striata | Pattern continuity countertop to backsplash

1.

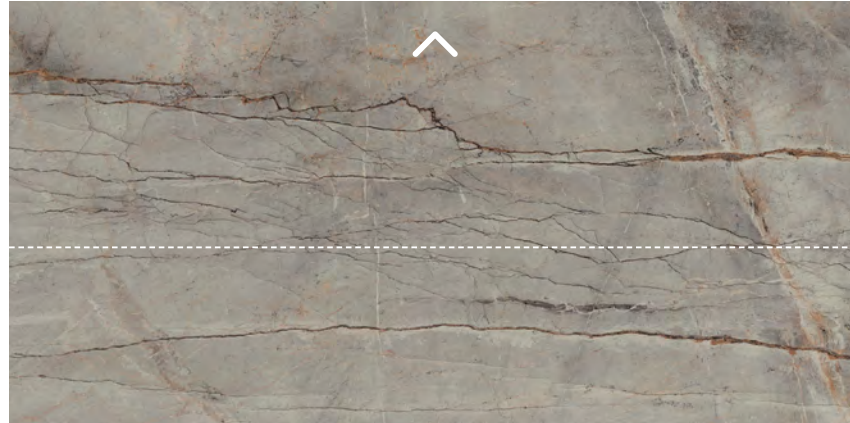

Cut the slab lengthwise

2.

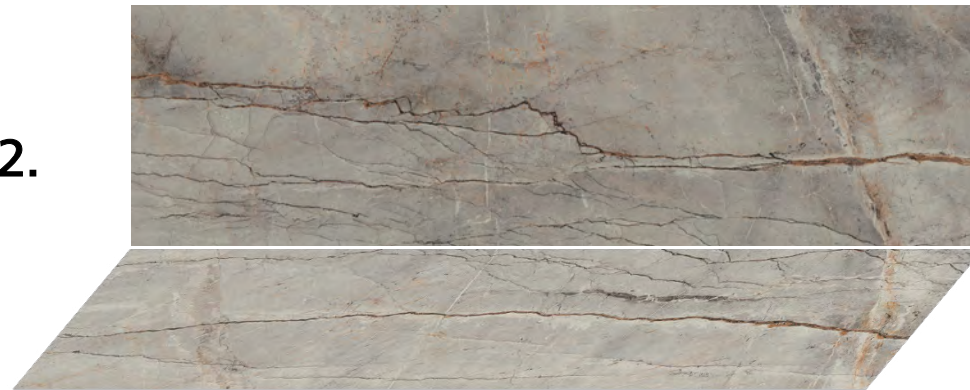

End result



# 513 Striata | End result



# 514 Emprada | Releasing slab tension

Full Slab

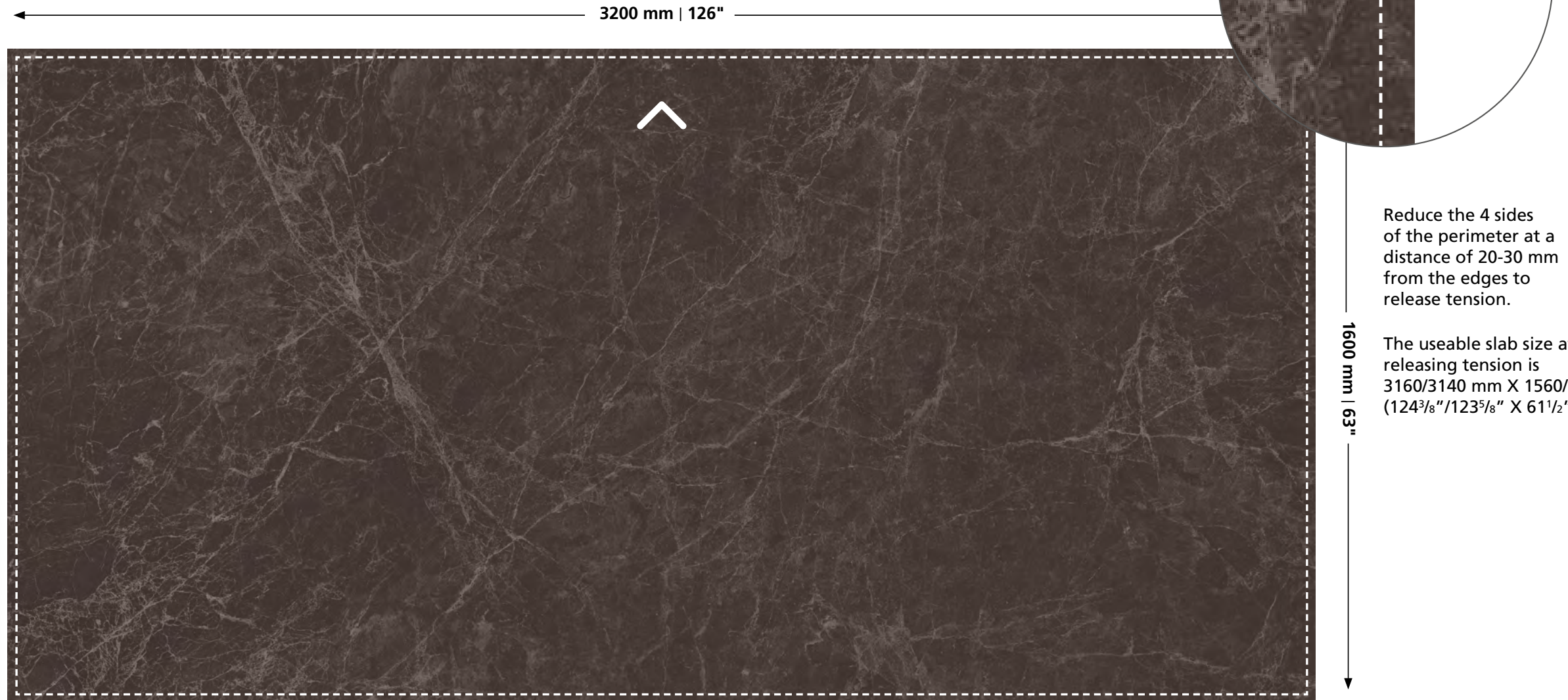

# 514 Emprada | Pattern continuity plan

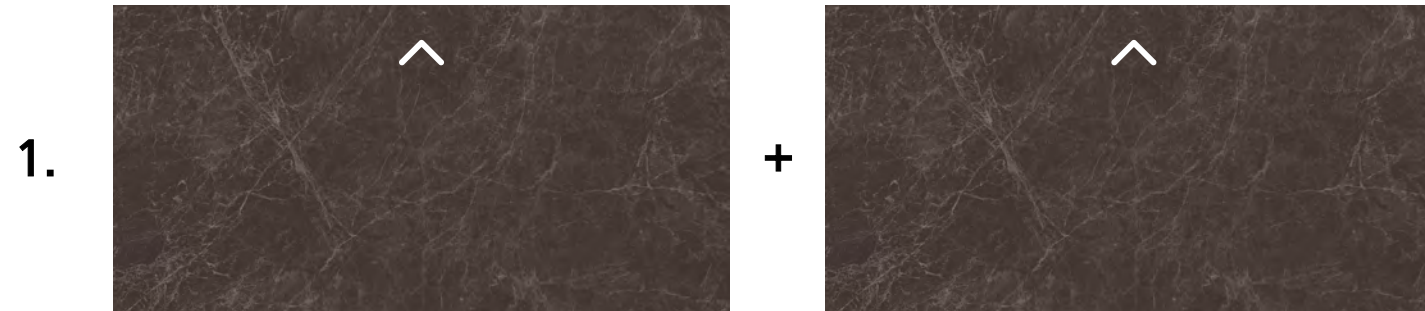

End result

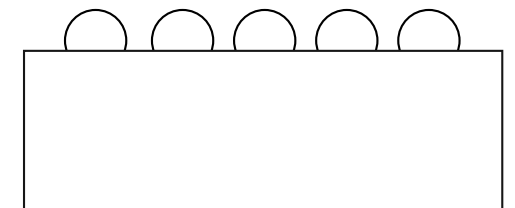

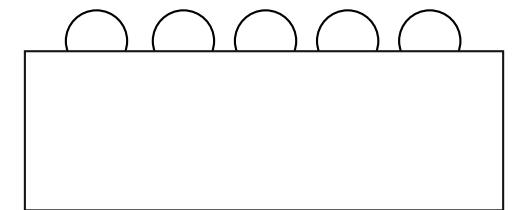
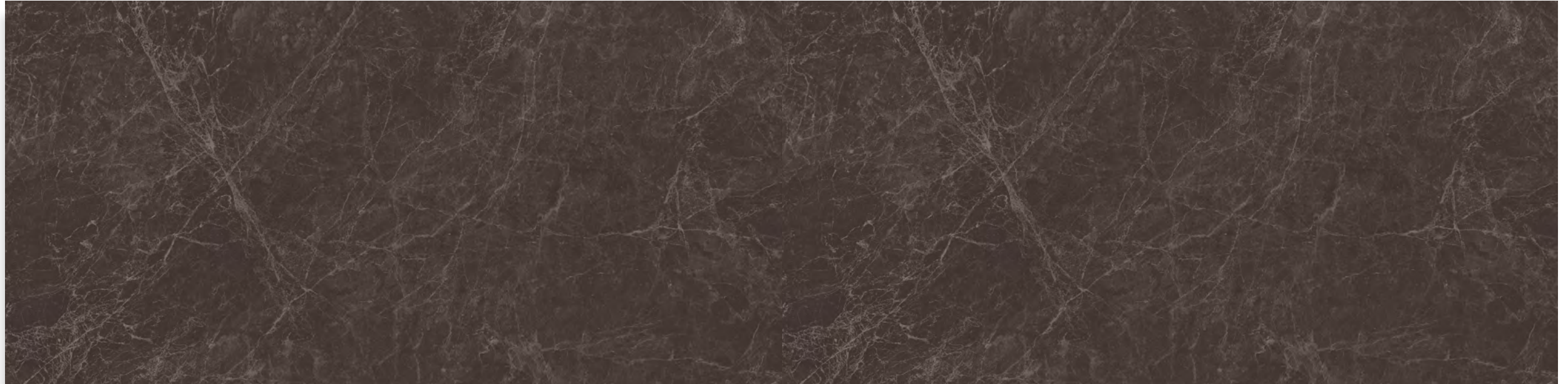

# 514 Emprada | Pattern continuity plan

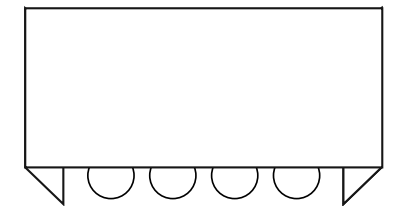
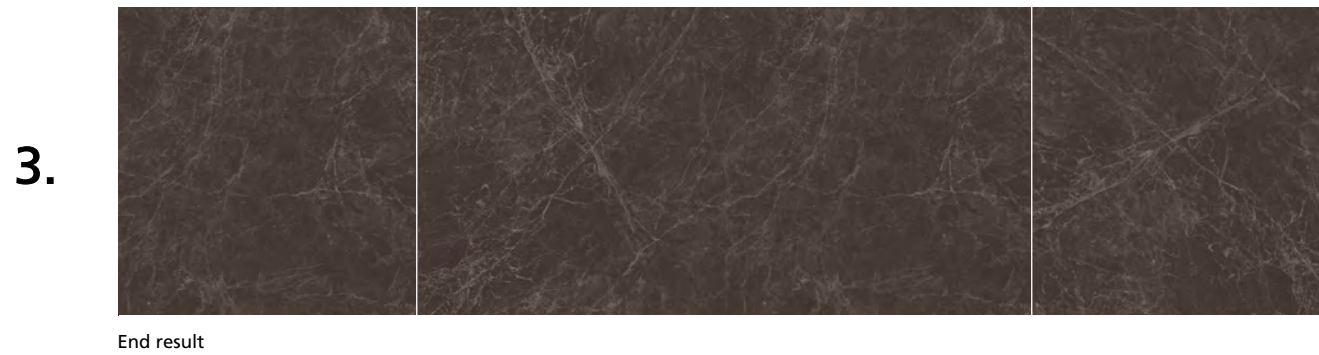
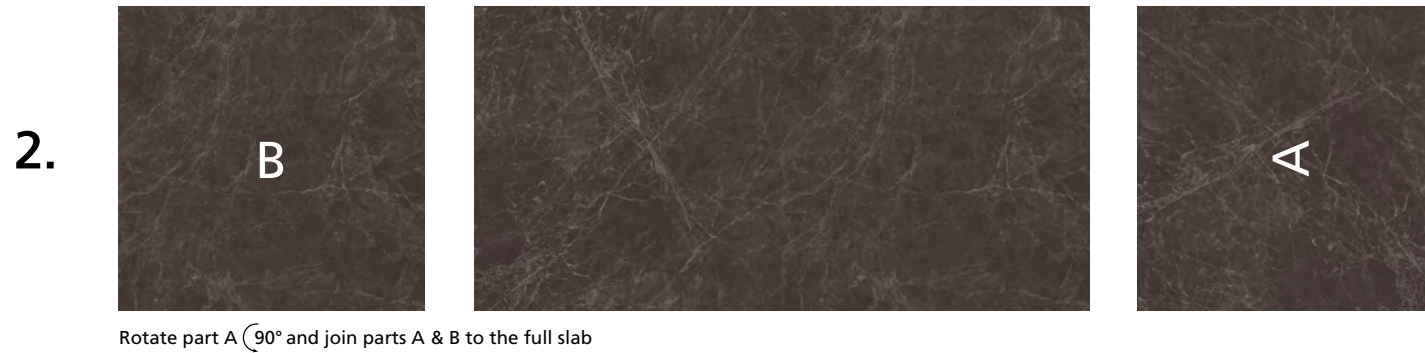
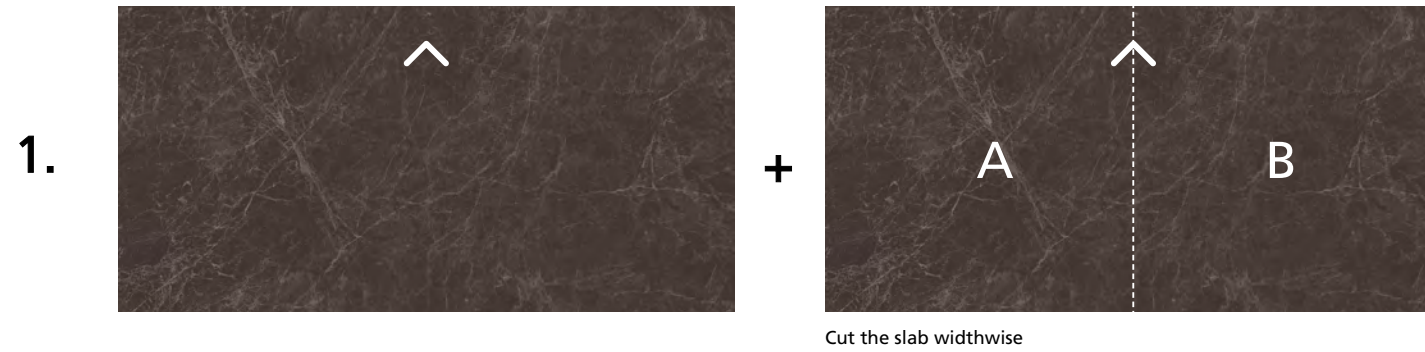

514 Emprada | End result

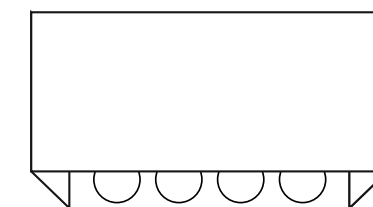
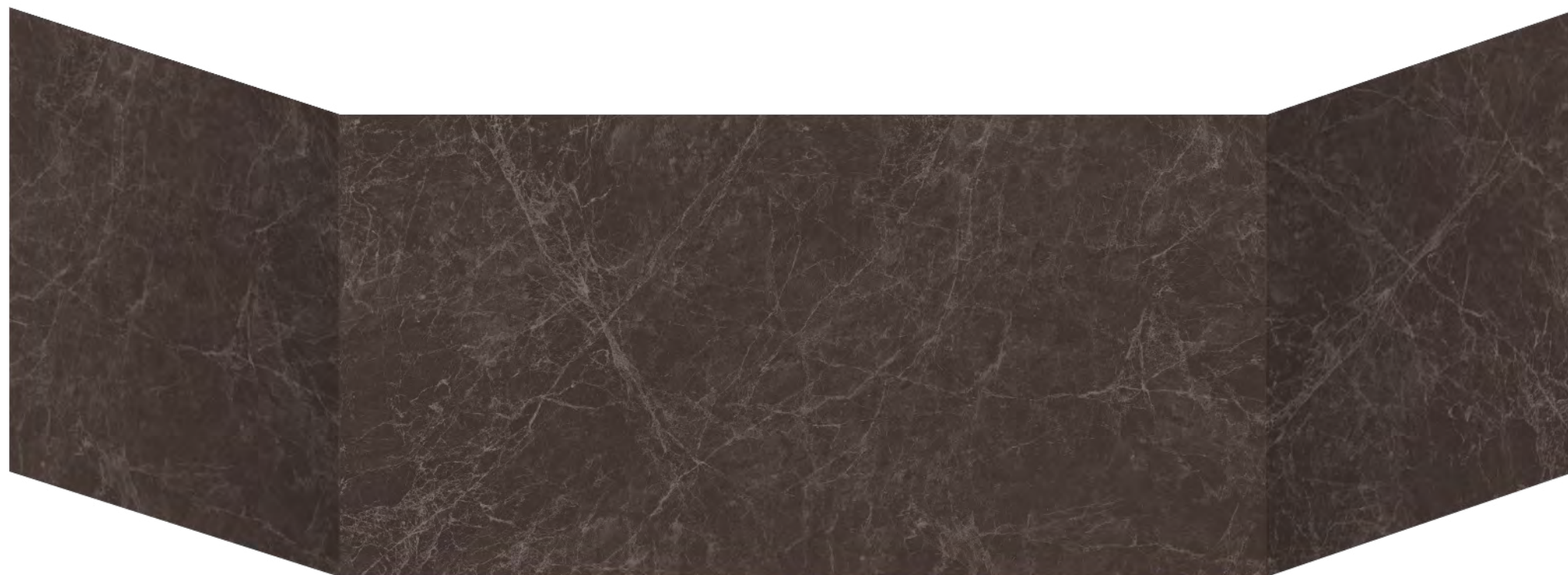

# 514 Emprada | Pattern continuity plan

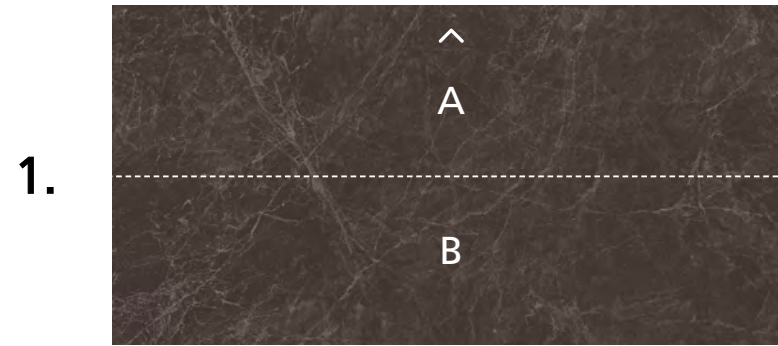

Cut the slab lengthwise

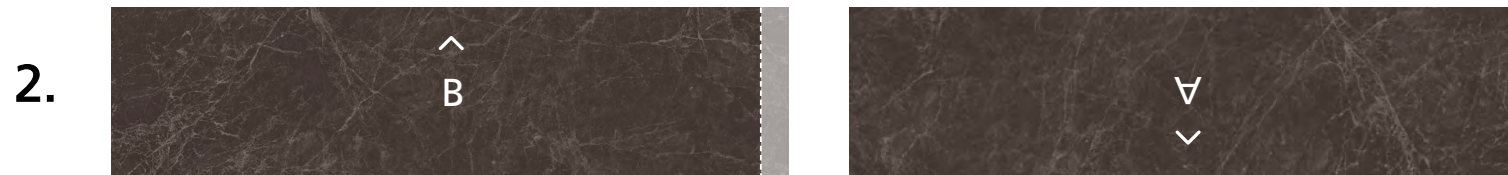

Rotate part A 180°. Plan to join parts A & B for continuation of the main veins and remove the surplus.

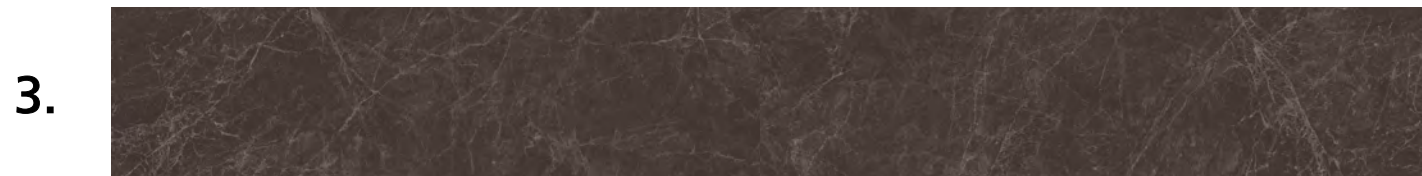

End result

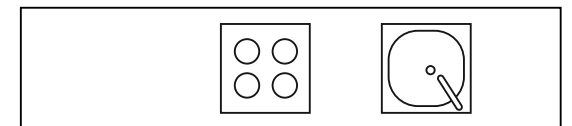

# 514 Emprada | End result

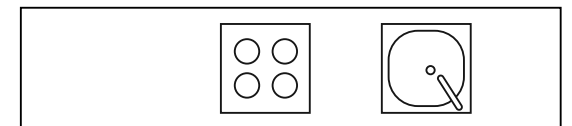
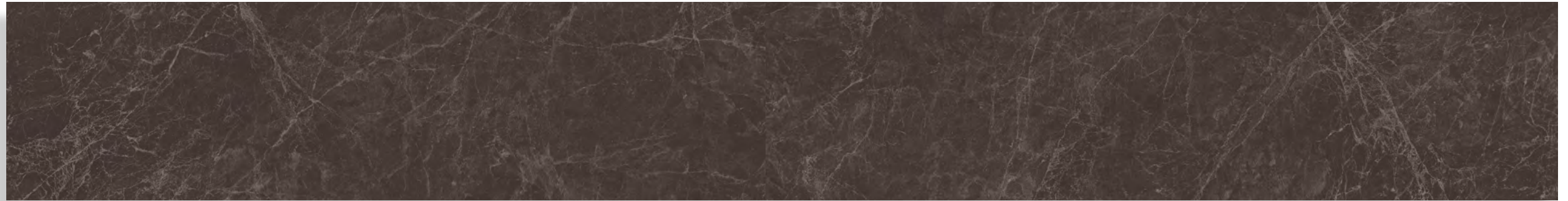

# 514 Emprada | Pattern continuity L-shape

1.

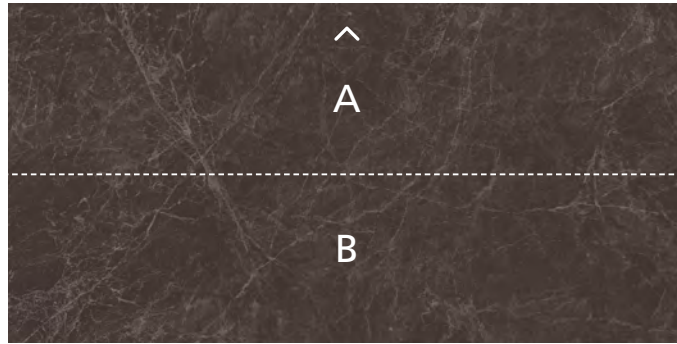

Cut the slab lengthwise

2.

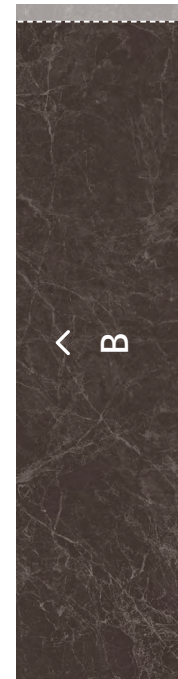
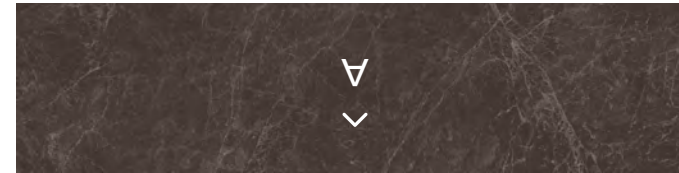

Rotate part B 90°. Rotate part A 180°. Plan to join parts A & B for continuation of the main veins and remove the surplus.

3.

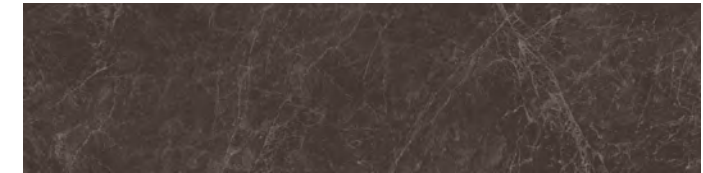

End result

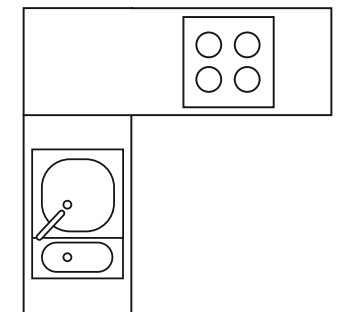

514 Emprada | End result

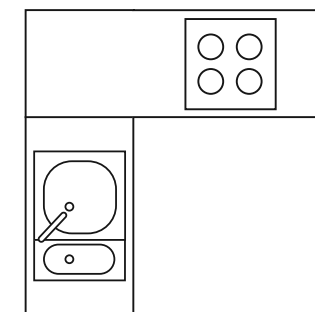

# 514 Emprada | Pattern continuity countertop to backsplash

1.

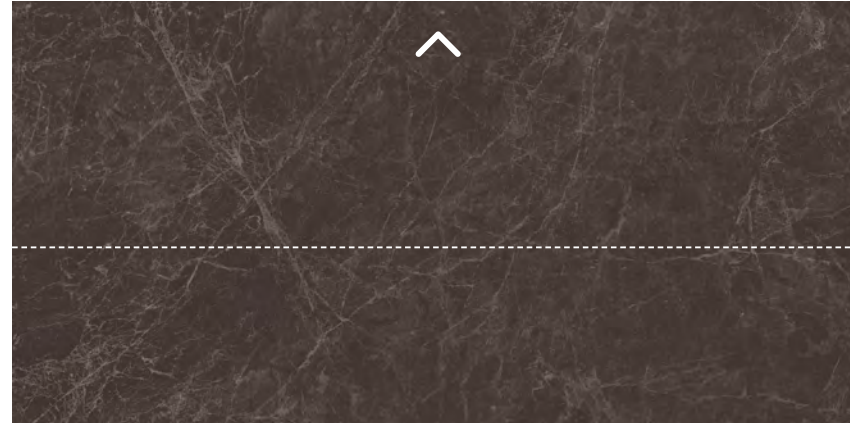

Cut the slab lengthwise

2.

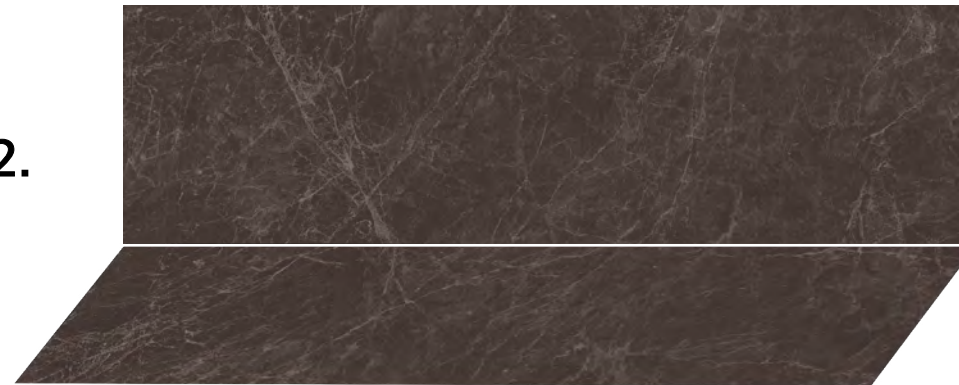

End result



# 514 Emprada | End result

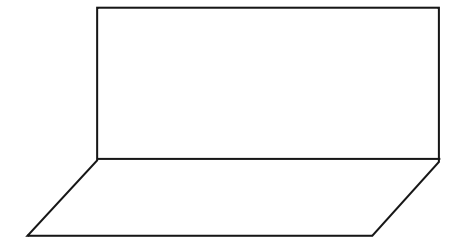
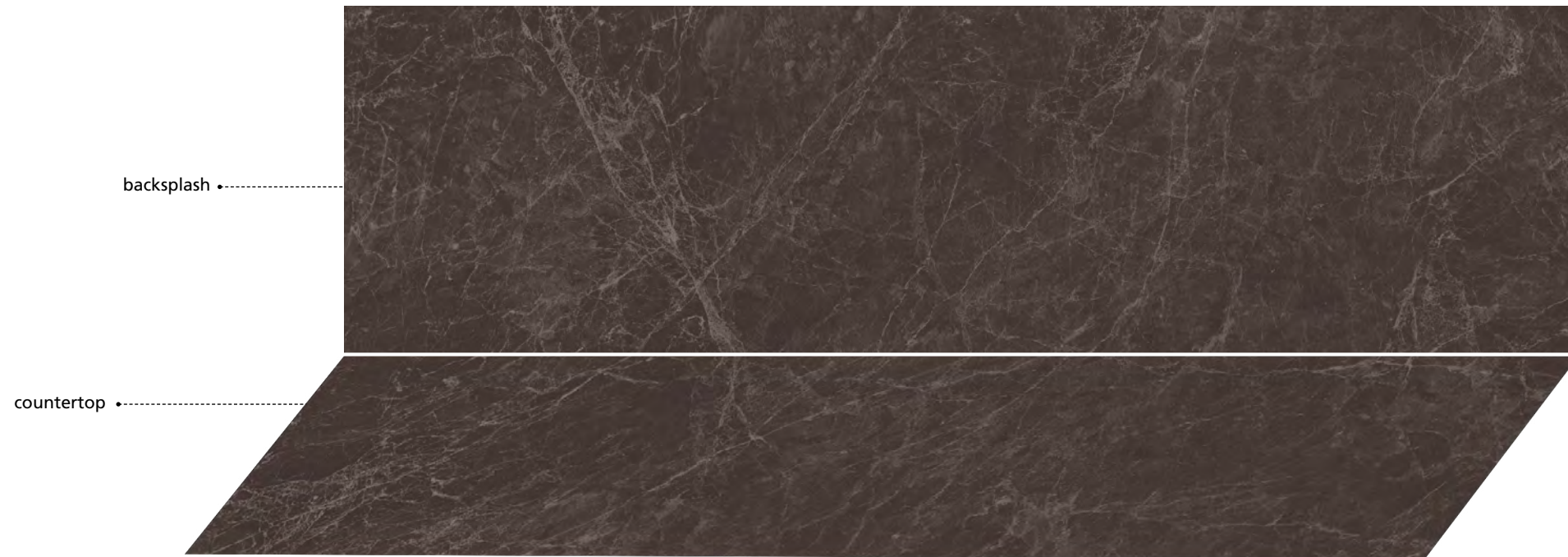

# 516 Locura | Releasing slab tension

Full Slab



Reduce the 4 sides of the perimeter at a distance of 20-30 mm from the edges to release tension.

The useable slab size after releasing tension is 3160/3140 mm X 1560/1540 mm. (124<sup>3</sup>/<sub>8</sub>"/123<sup>5</sup>/<sub>8</sub>" X 61<sup>1</sup>/<sub>2</sub>"/60<sup>5</sup>/<sub>8</sub>" )

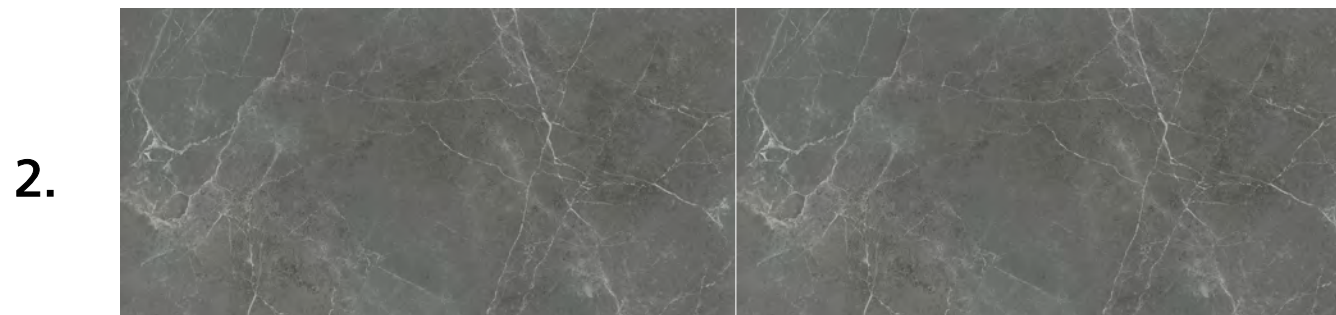
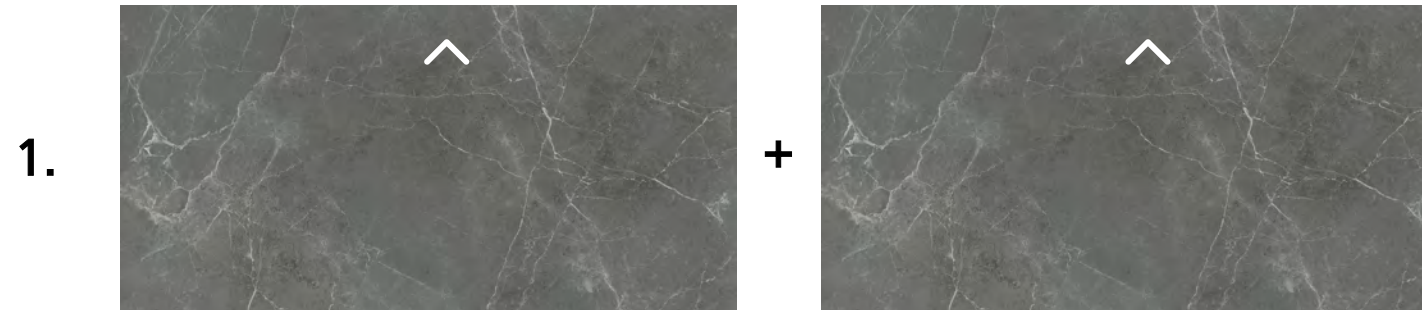

End result

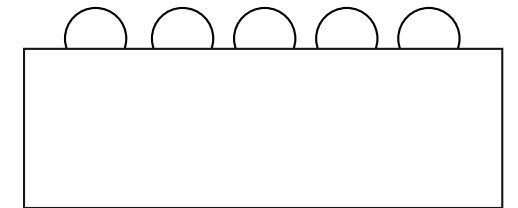

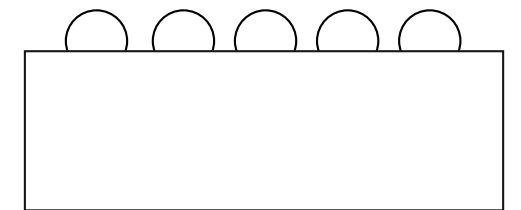
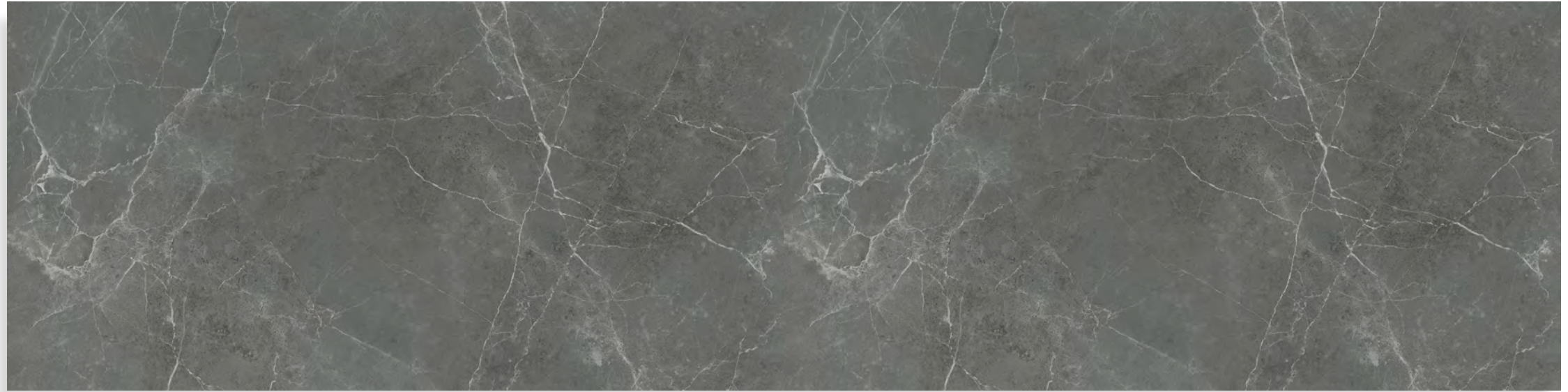

# 516 Locura | Pattern continuity plan

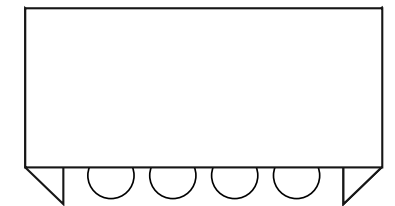
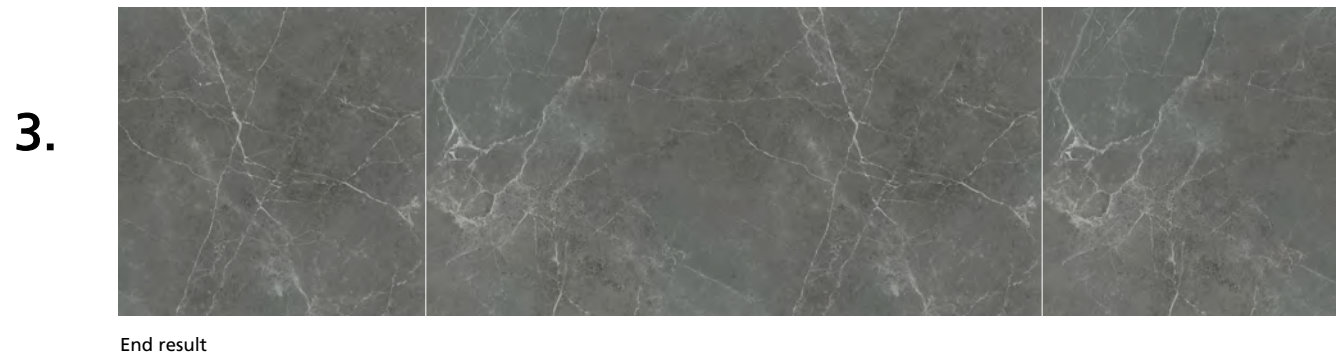
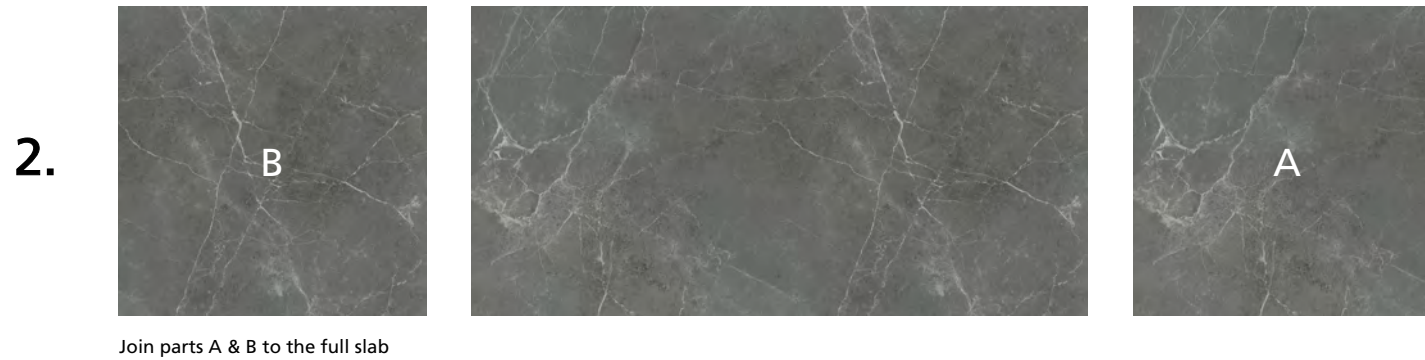
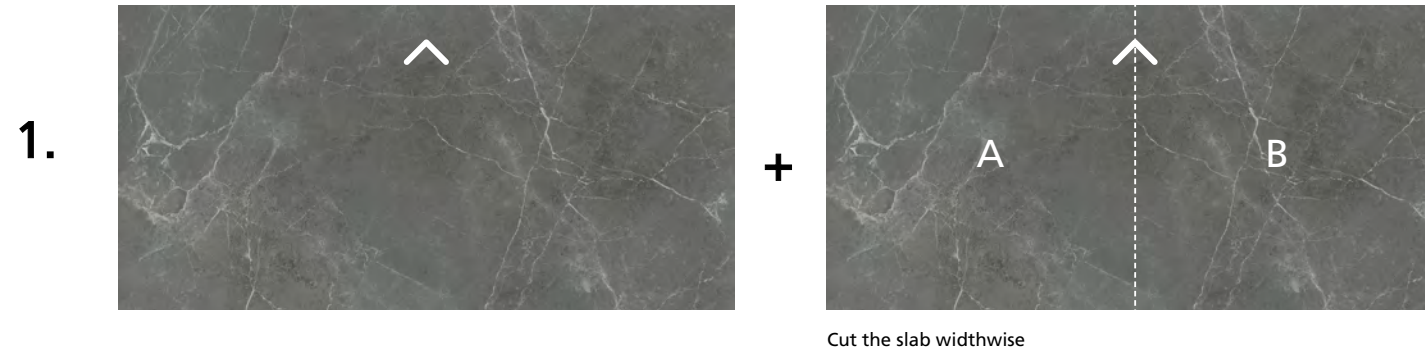

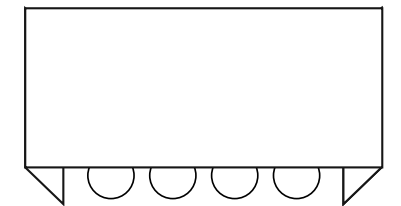

# 516 Locura | Pattern continuity plan

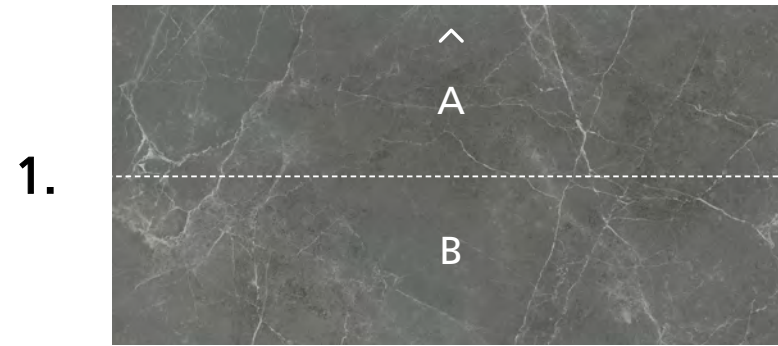

Cut the slab lengthwise

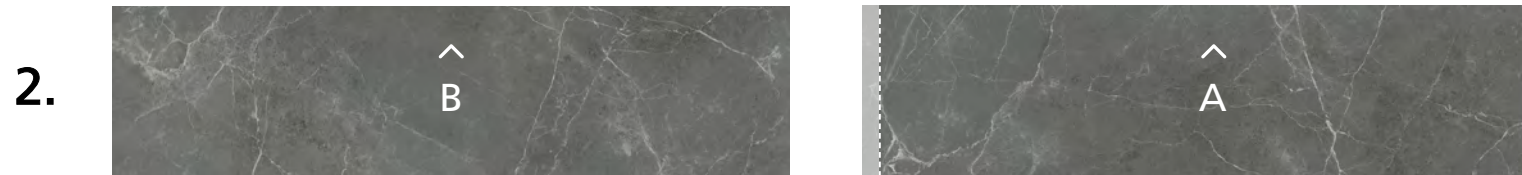

Plan to join parts A & B for continuation of the main vein and remove the surplus

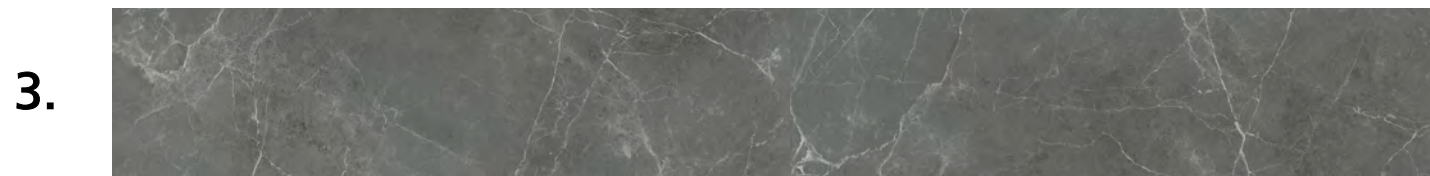

End result

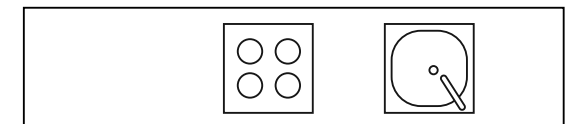

516 Locura | End result

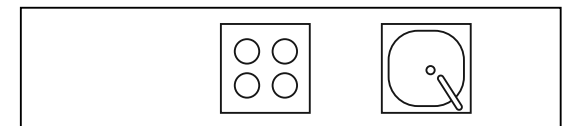
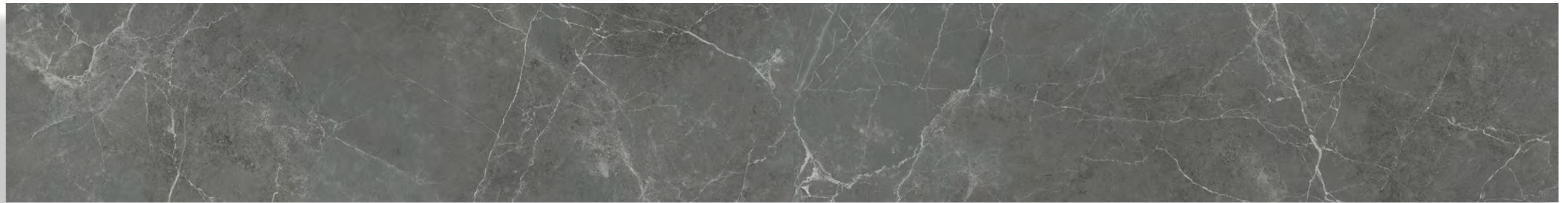

# 516 Locura | Pattern continuity L-shape

1.

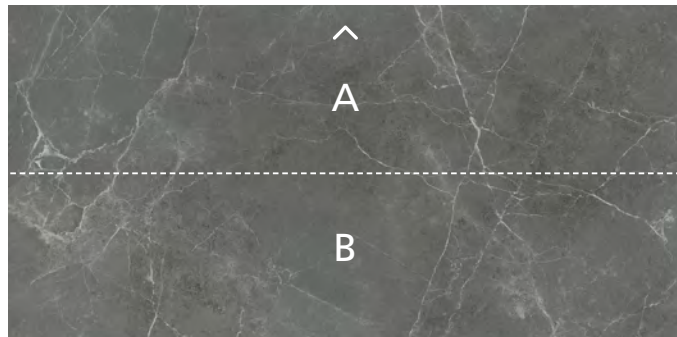

Cut the slab lengthwise

2.

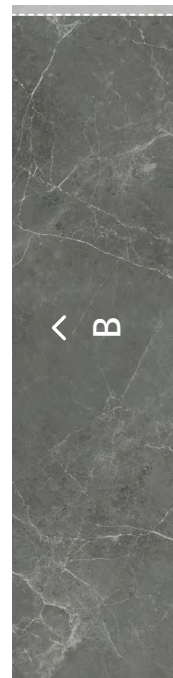
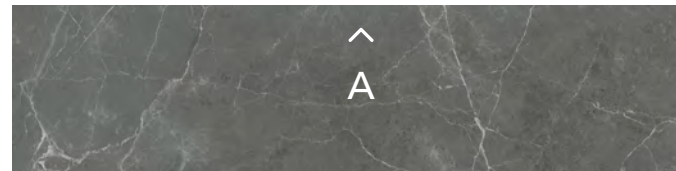

Rotate part B 90°. Plan to join parts A & B for continuation of the main vein and remove the surplus.

3.

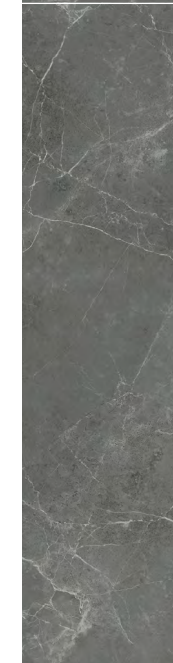
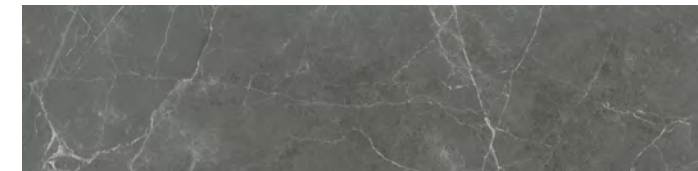

End result

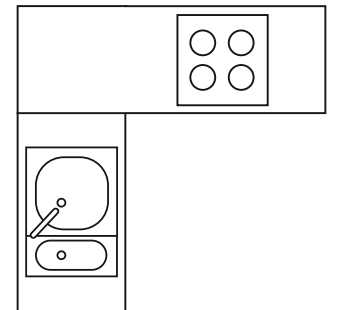

516 Locura | End result

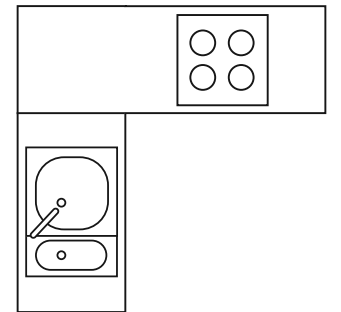

# 516 Locura | Pattern continuity countertop to backsplash

1.

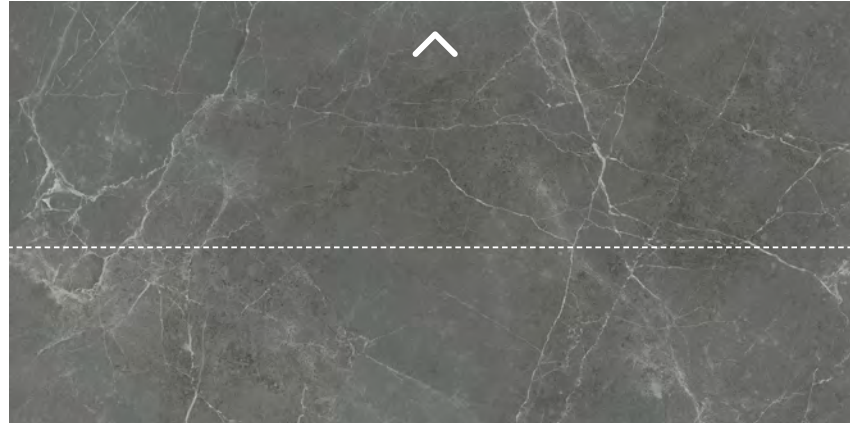

Cut the slab lengthwise

2.

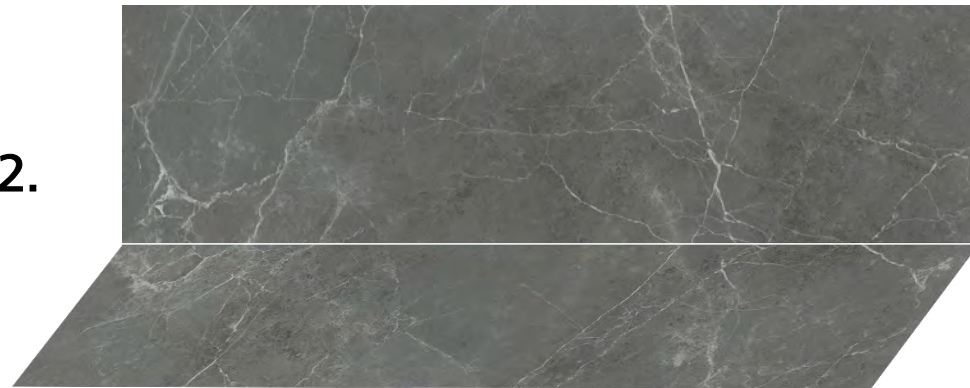

End result



# 516 Locura | End result

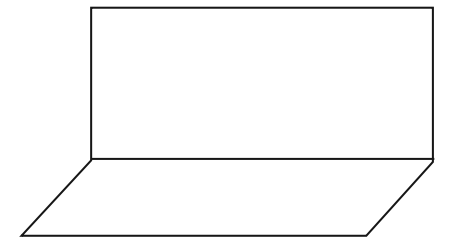
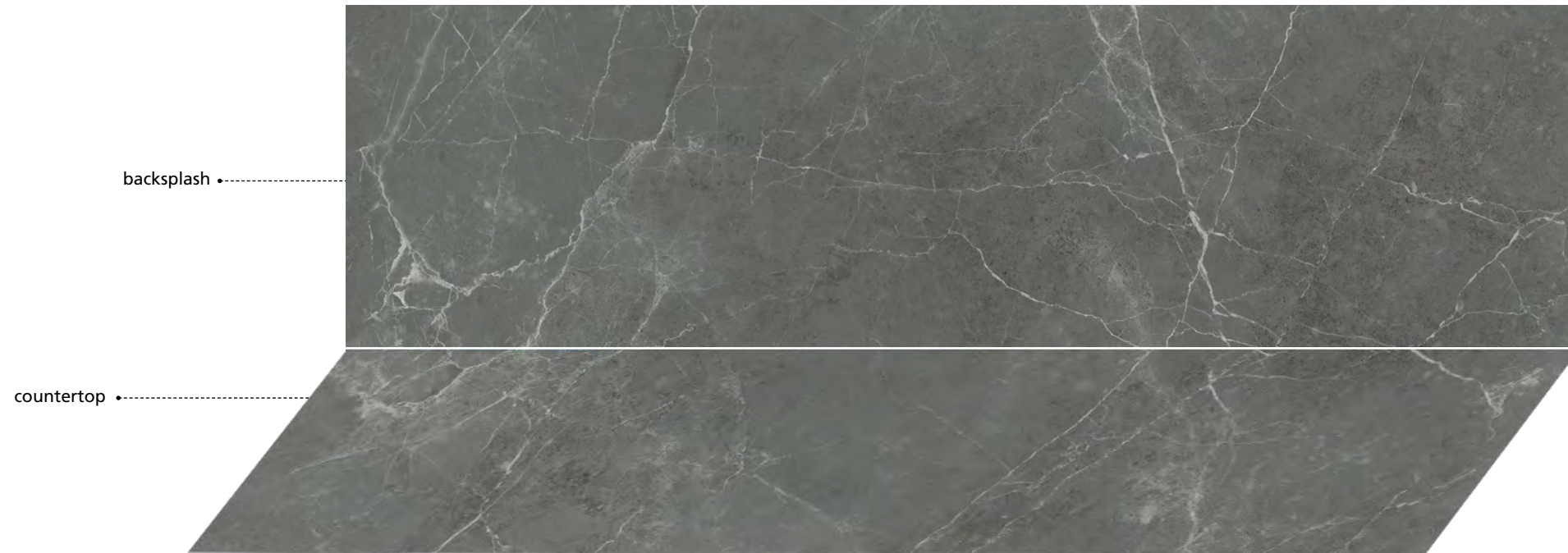

# 531 Libretta | Releasing slab tension

Full Slab

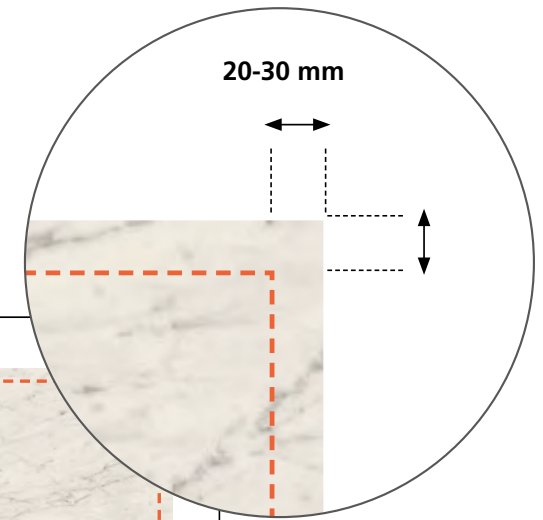
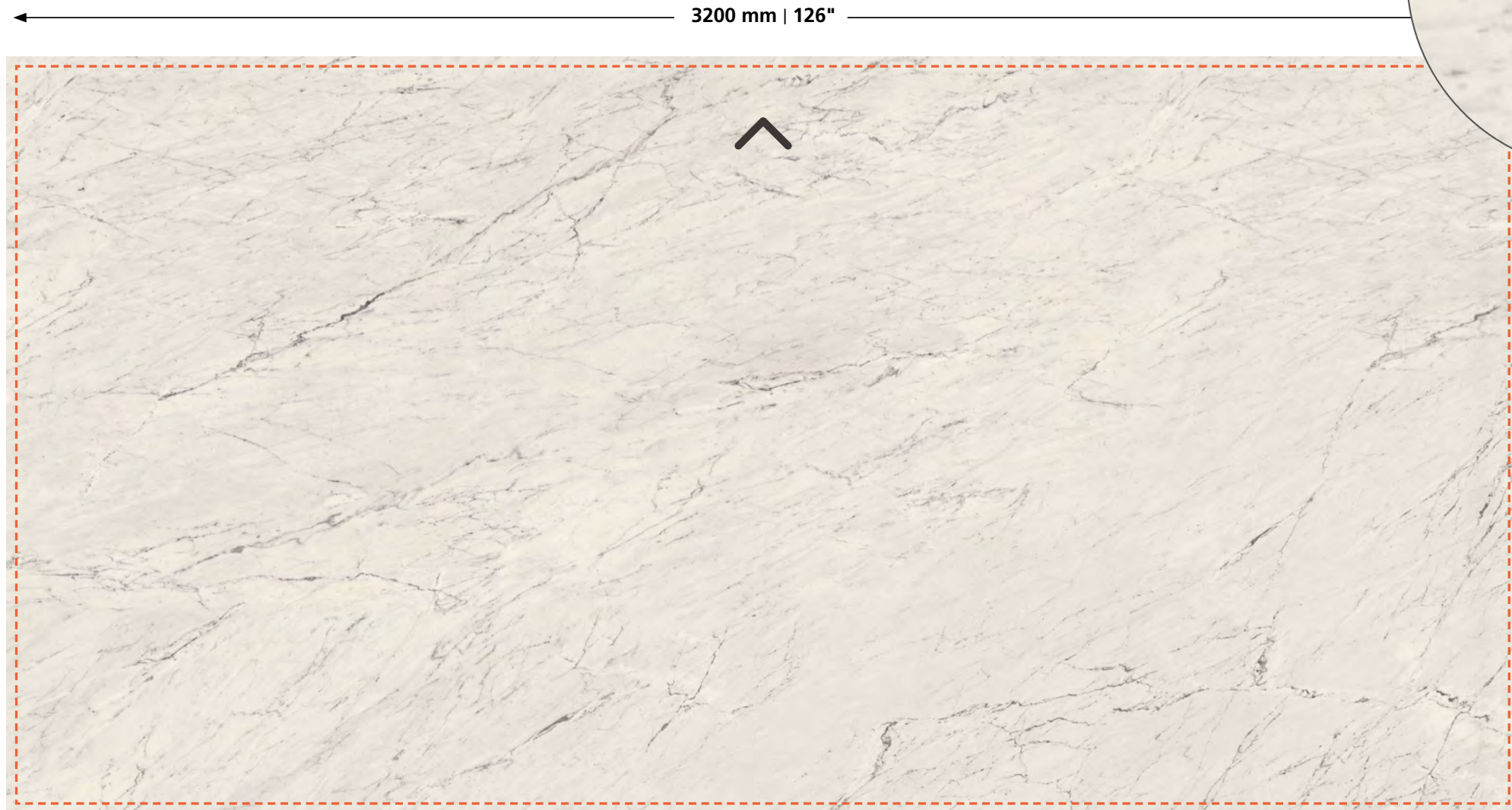

Reduce the 4 sides of the perimeter at a distance of 20-30 mm from the edges to release tension.

The useable slab size after releasing tension is 3160/3140 mm X 1560/1540 mm. (124<sup>3</sup>/<sub>8</sub>"/123<sup>5</sup>/<sub>8</sub>" X 61<sup>1</sup>/<sub>2</sub>"/60<sup>5</sup>/<sub>8</sub>" )

1600 mm | 63"

# 531 Libretta | Pattern continuity plan

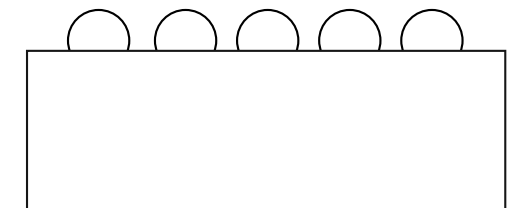
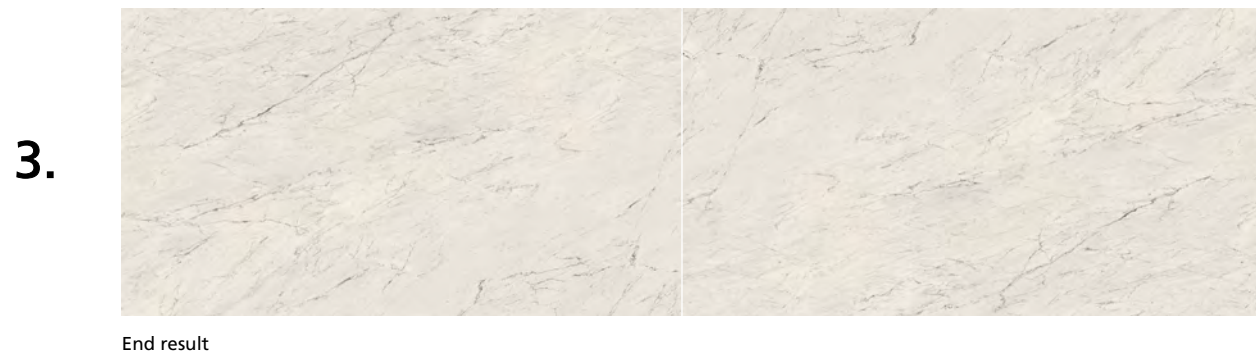

531 Libretta | End result

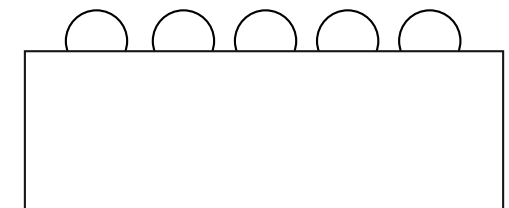

# 531 Libretta | Pattern continuity plan

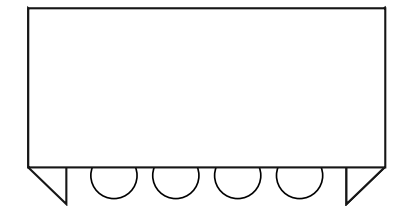
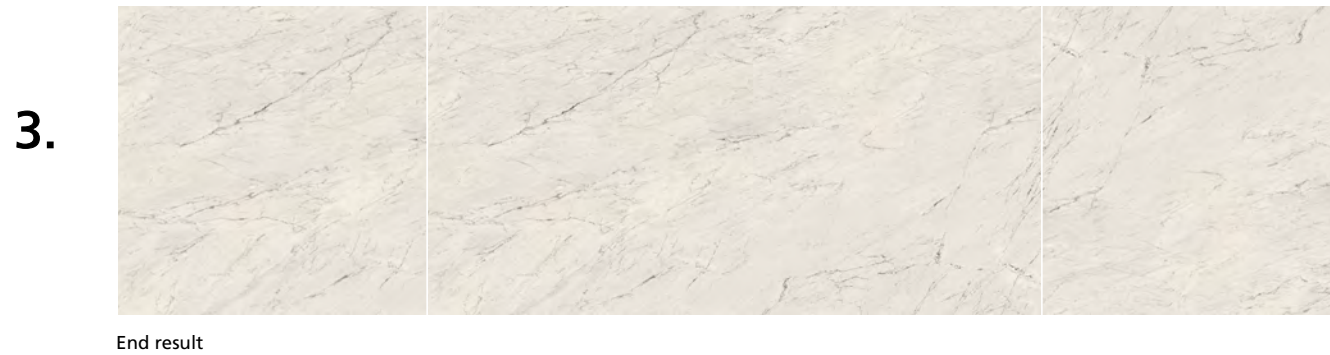

531 Libretta | End result

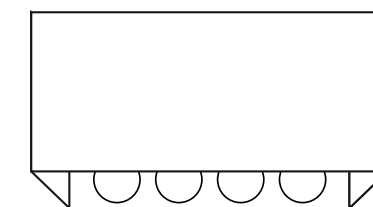
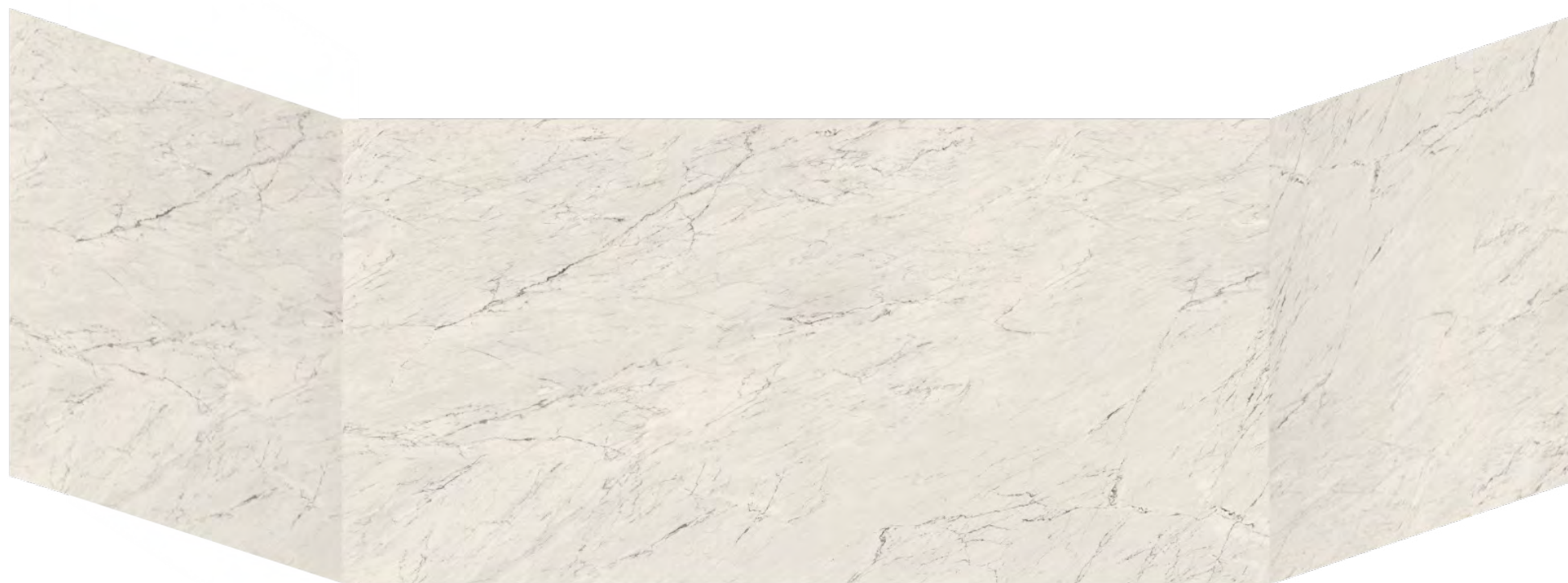

# 531 Libretta | Pattern continuity plan

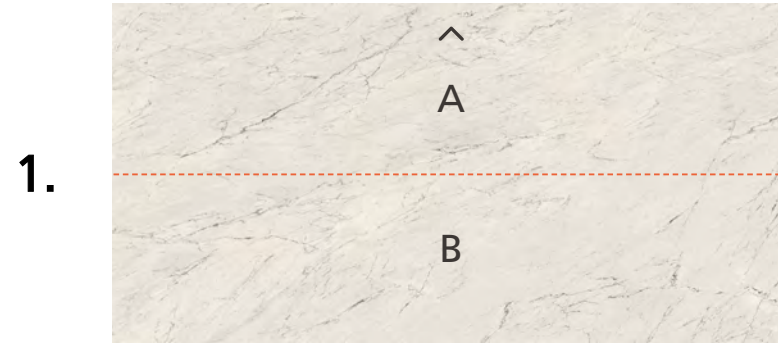

Cut the slab lengthwise

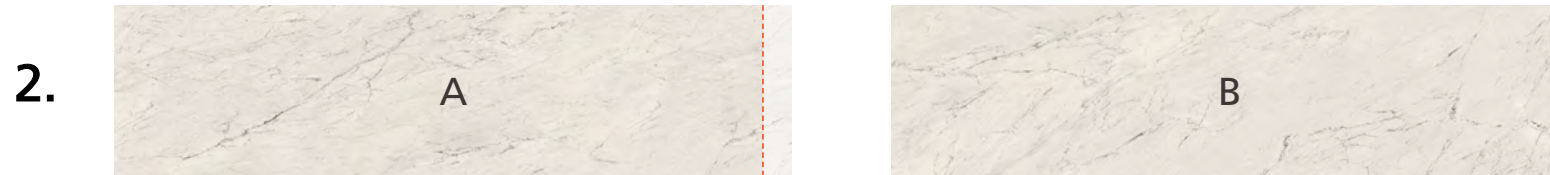

Plan to join parts A & B for continuation of the main veins and remove the surplus

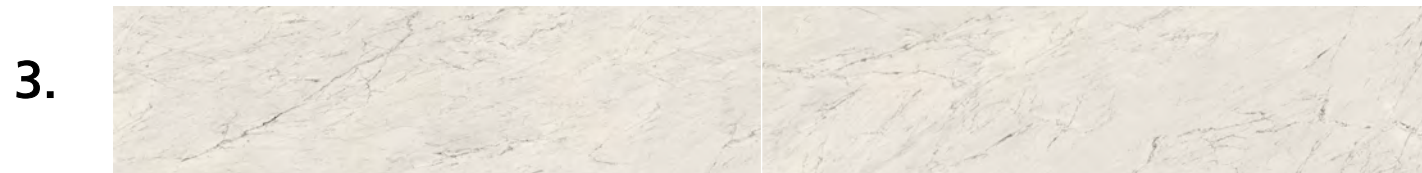

End result

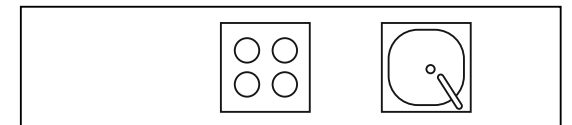

# 531 Libretta | End result

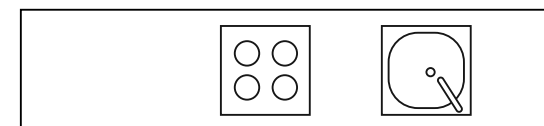

# 531 Libretta | Pattern continuity L-shape

1.

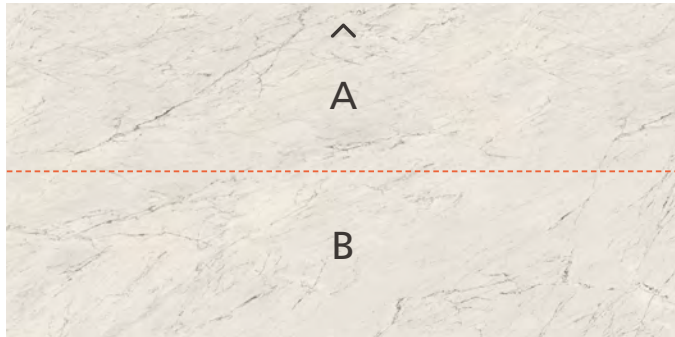

Cut the slab lengthwise

2.

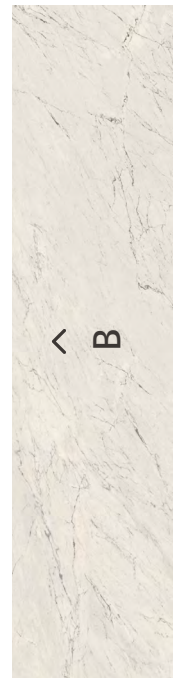
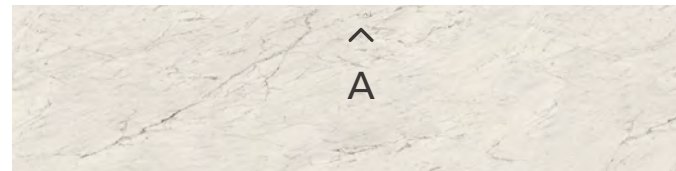

Rotate part B (90°) and join parts A & B

3.

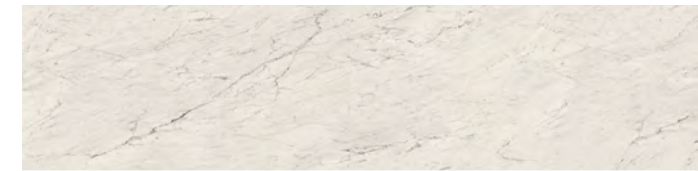

End result

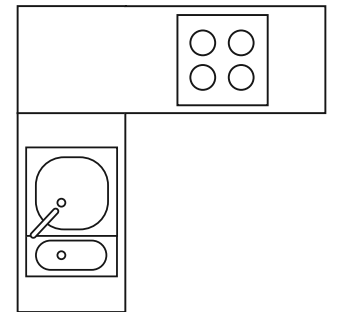

# 531 Libretta | End result

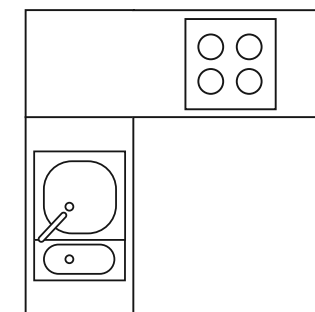
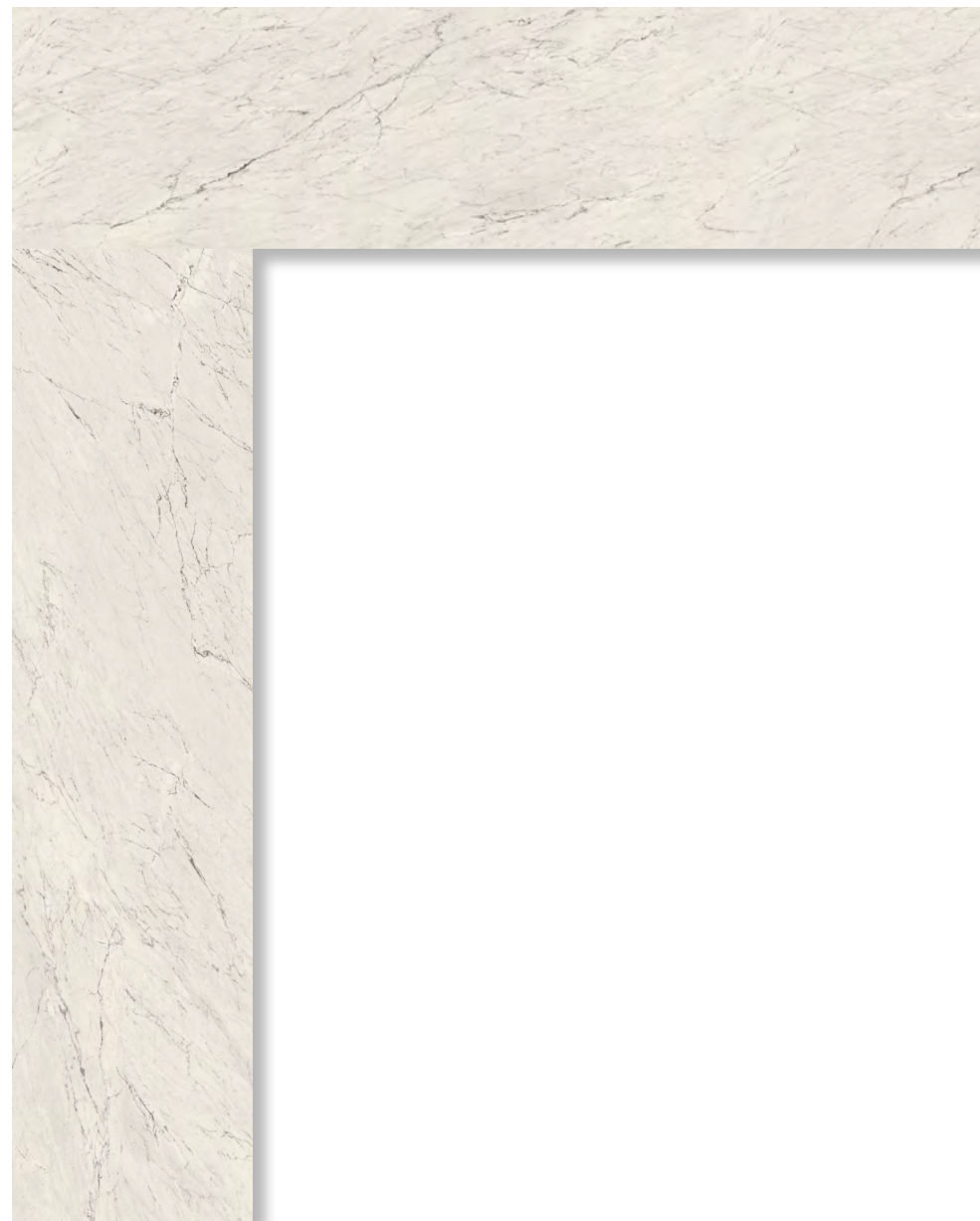

# 531 Libretta | Pattern continuity countertop to backsplash

1.

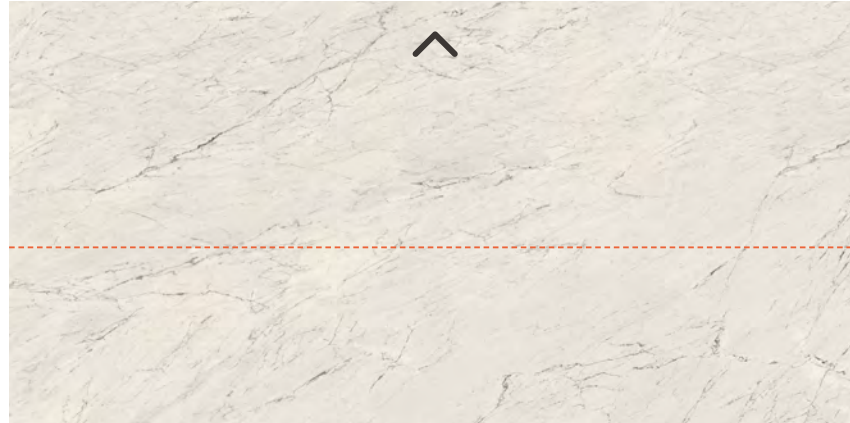

Cut the slab lengthwise

2.



End result



# 531 Libretta | End result

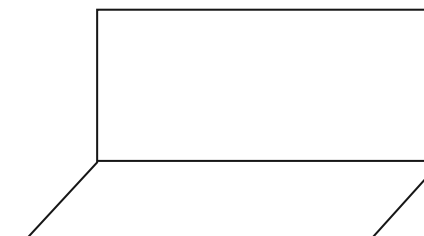
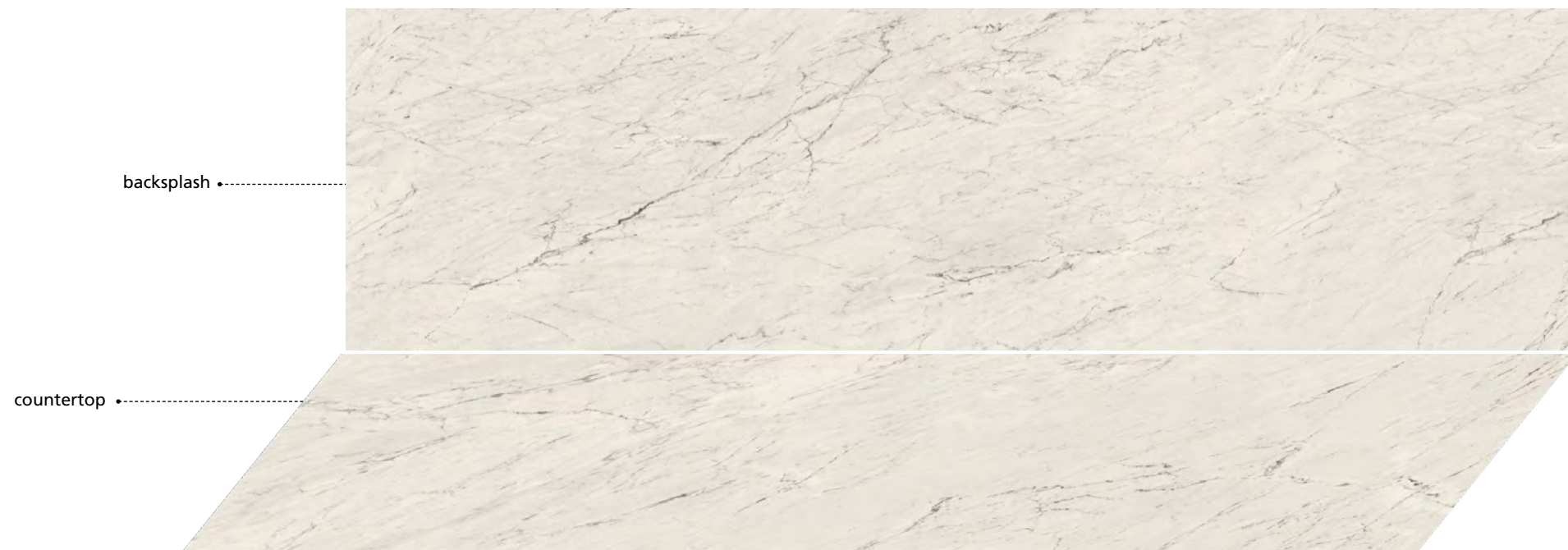

# 533 Silverdrop | Releasing slab tension

Full Slab

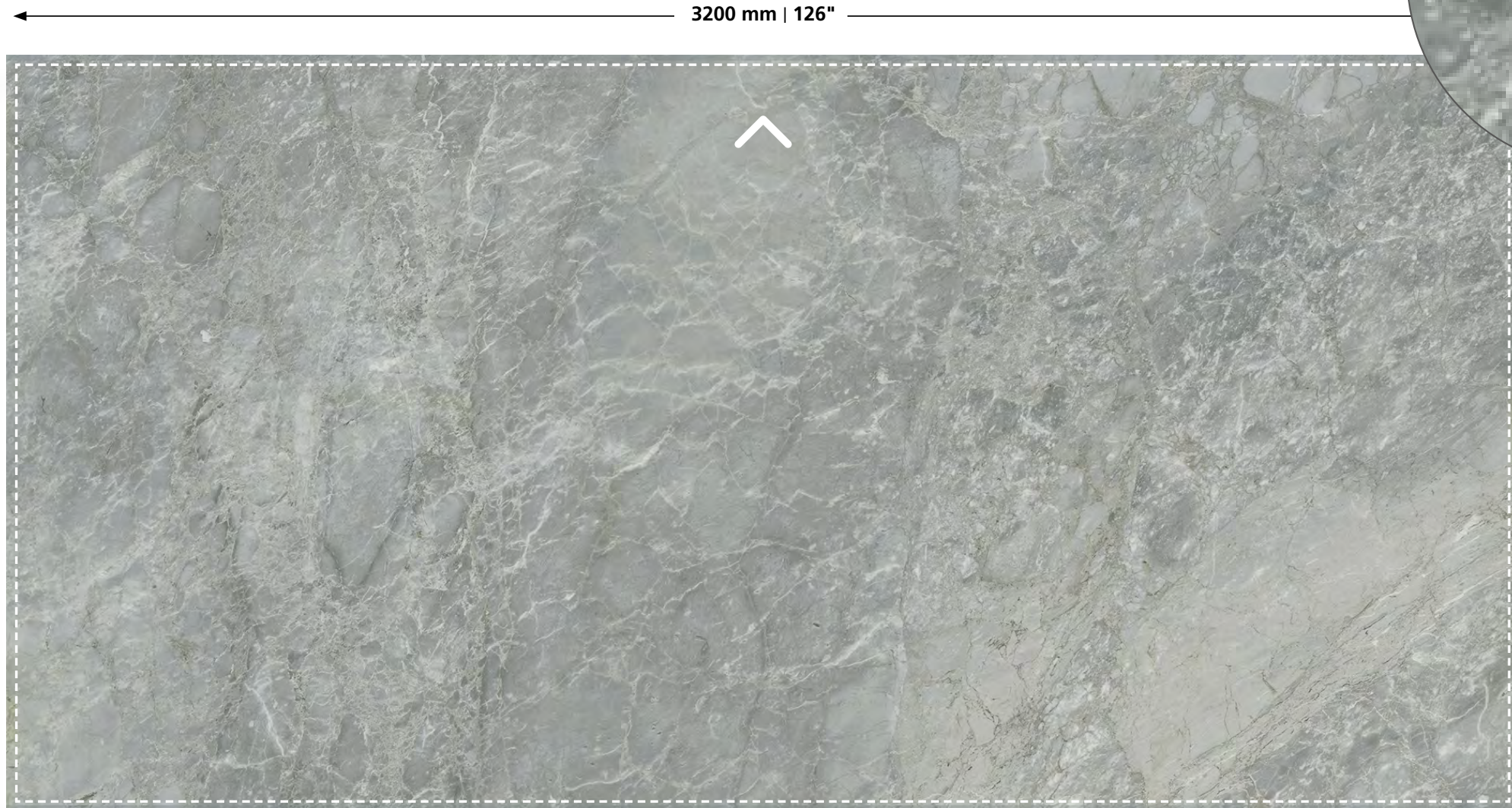

3200 mm | 126"

20-30 mm

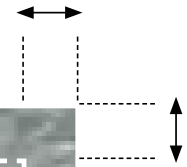

Reduce the 4 sides of the perimeter at a distance of 20-30 mm from the edges to release tension.

The useable slab size after releasing tension is 3160/3140 mm X 1560/1540 mm. (124<sup>3/8</sup>"/123<sup>5/8</sup>" X 61<sup>1/2</sup>"/60<sup>5/8</sup>" )

1600 mm | 63"

# 533 Silverdrop | Pattern continuity plan

1.



Rotate one slab 180°

2.



End result

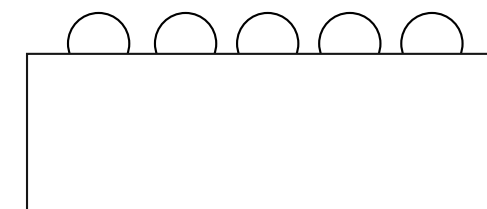

# 533 Silverdrop | End result

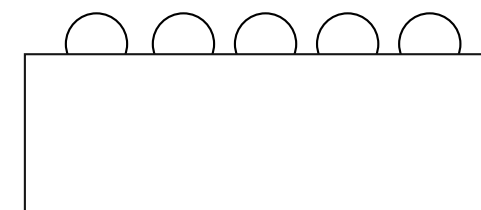

# 533 Silverdrop | Pattern continuity plan

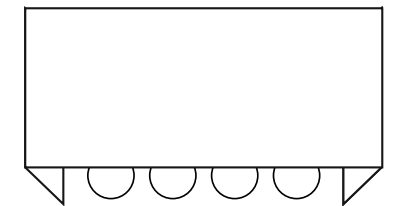
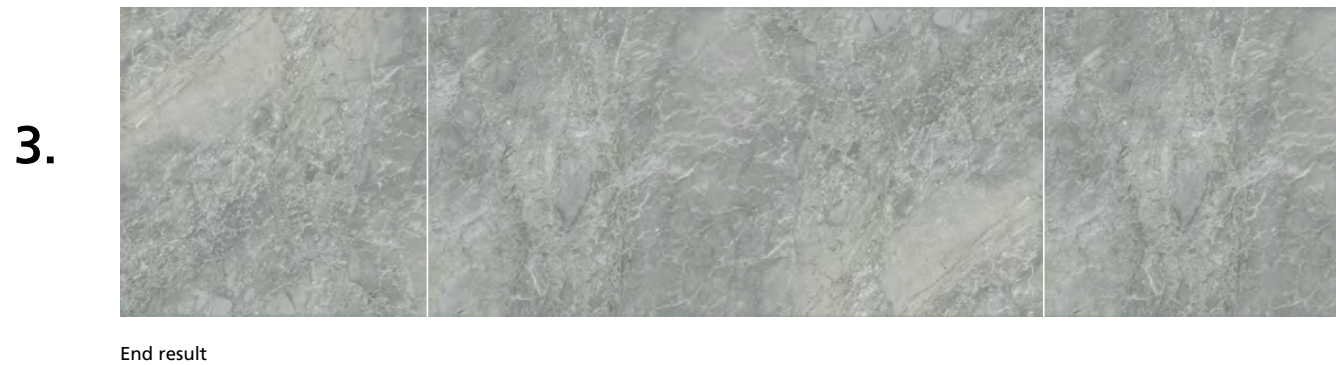
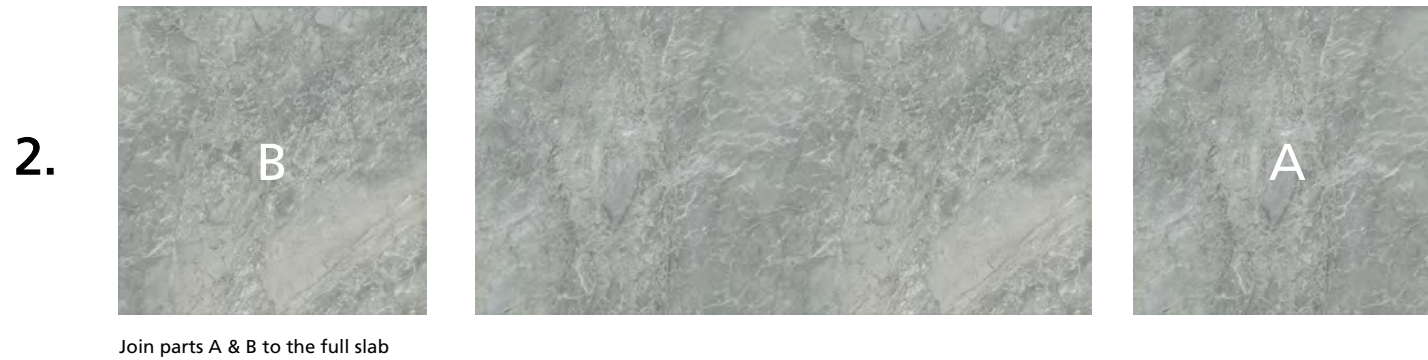

# 533 Silverdrop | End result

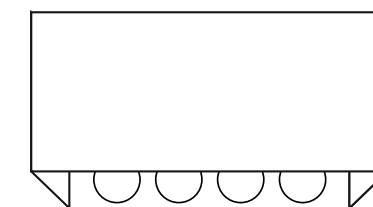
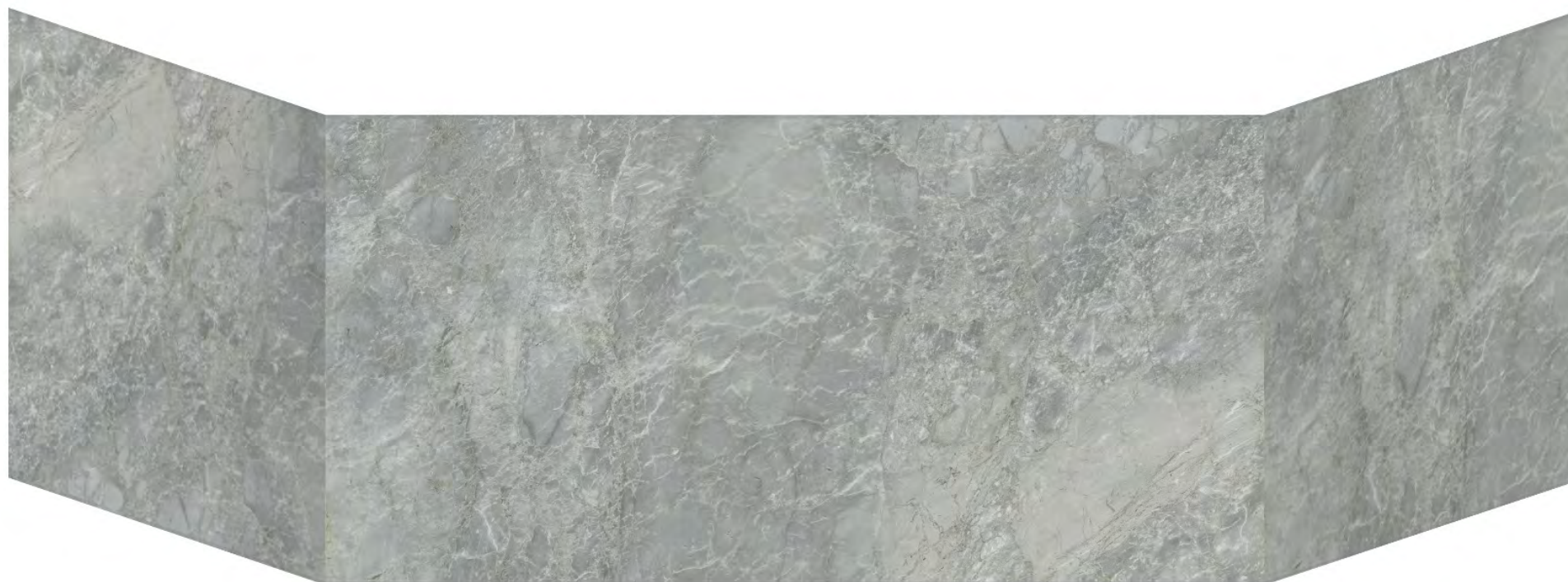

# 533 Silverdrop | Pattern continuity plan

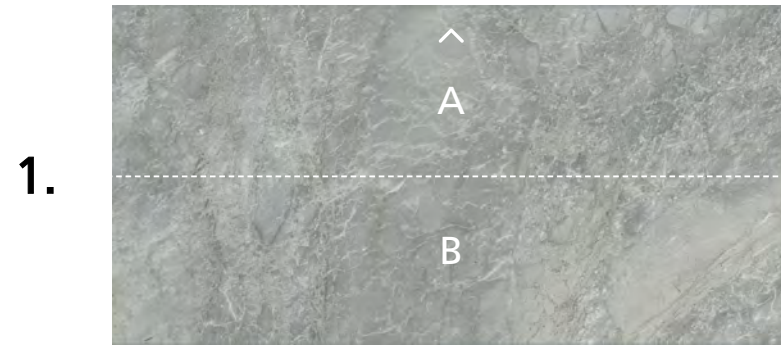

Cut the slab lengthwise

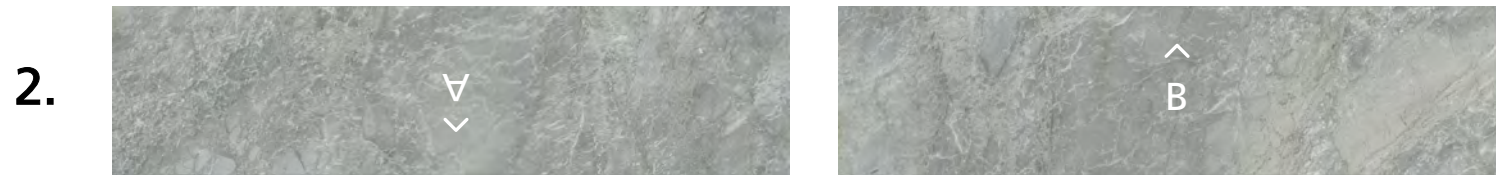

Rotate part A 180° and join parts A & B

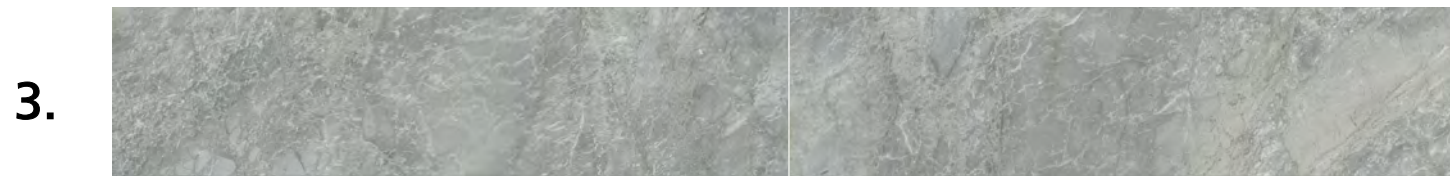

End result

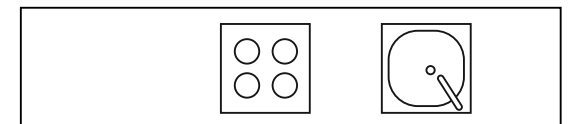

# 533 Silverdrop | End result

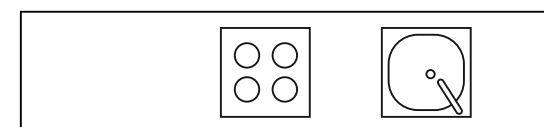

# 533 Silverdrop | Pattern continuity L-shape

1.

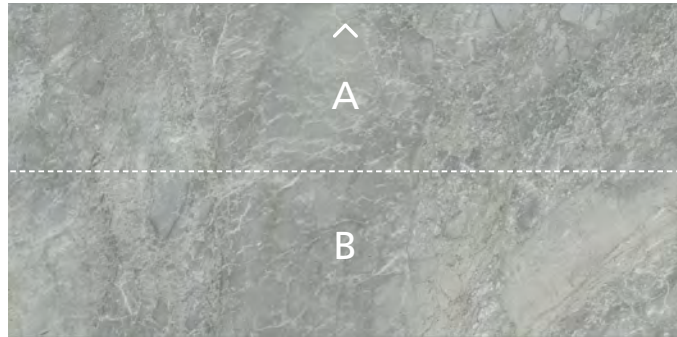

Cut the slab lengthwise

2.

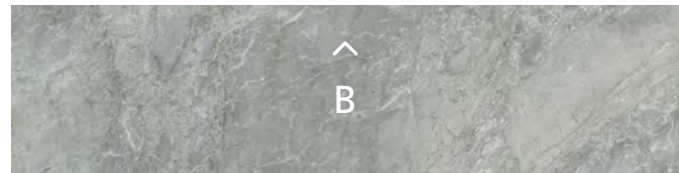

Rotate part A 90° and join parts A & B

3.

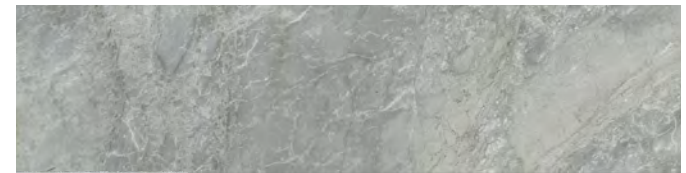

End result

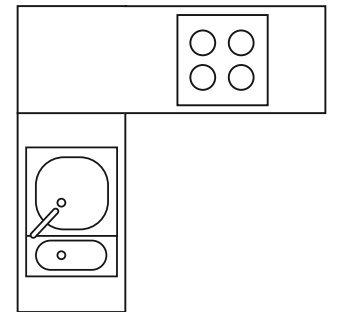

# 533 Silverdrop | End result

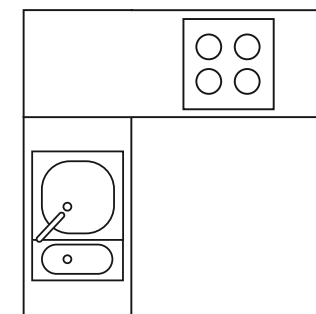
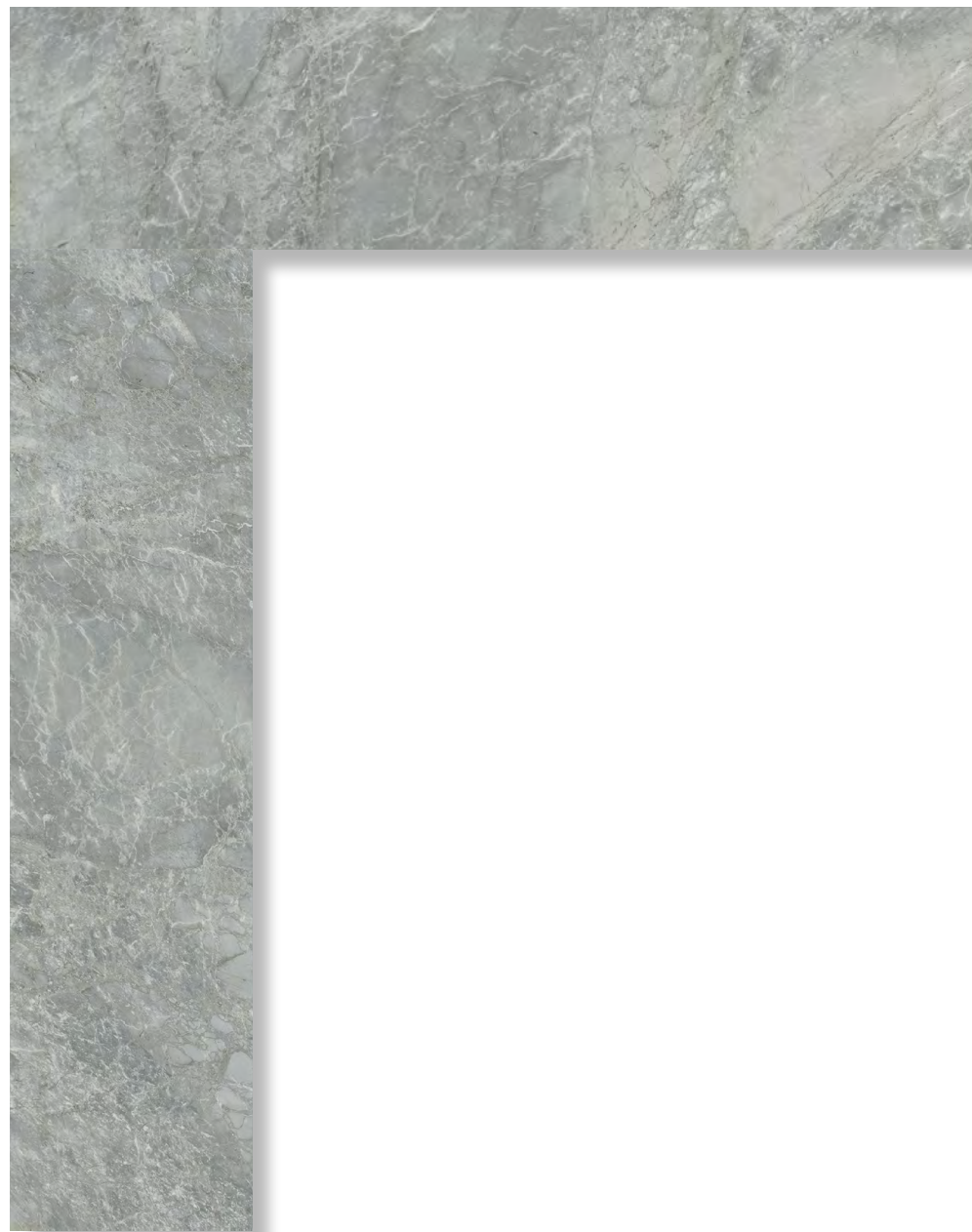

# 533 Silverdrop | Pattern continuity countertop to backsplash

1.

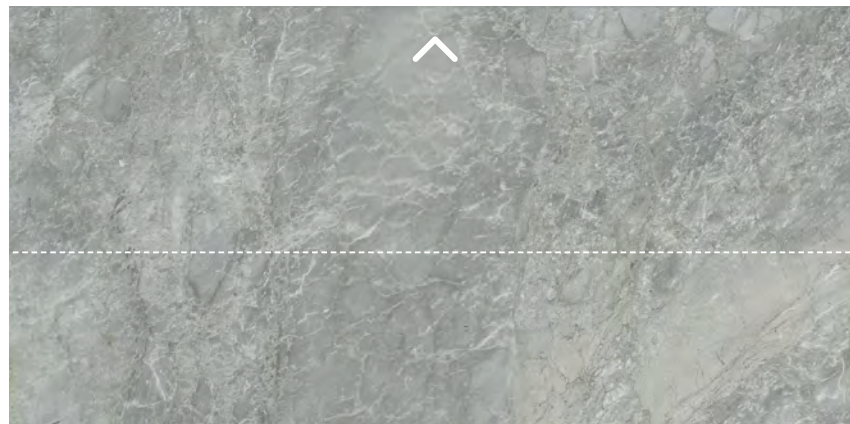

Cut the slab lengthwise

2.

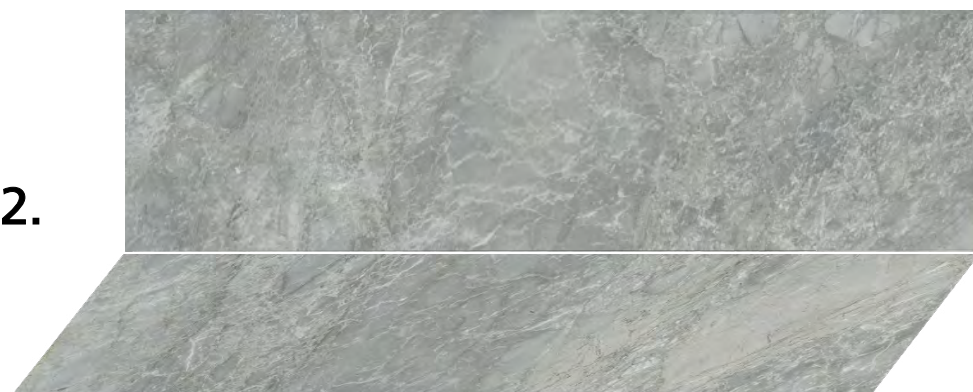

End result

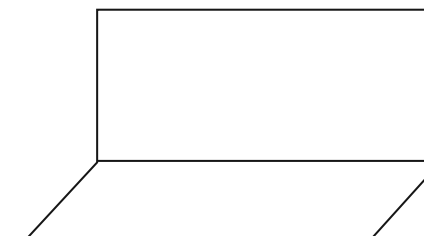

# 533 Silverdrop | End result

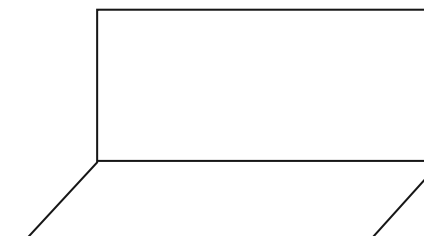

# 540 Monumental | Releasing slab tension

Full Slab

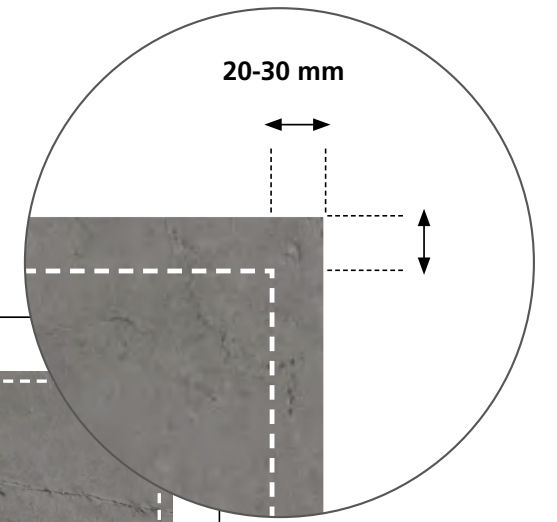
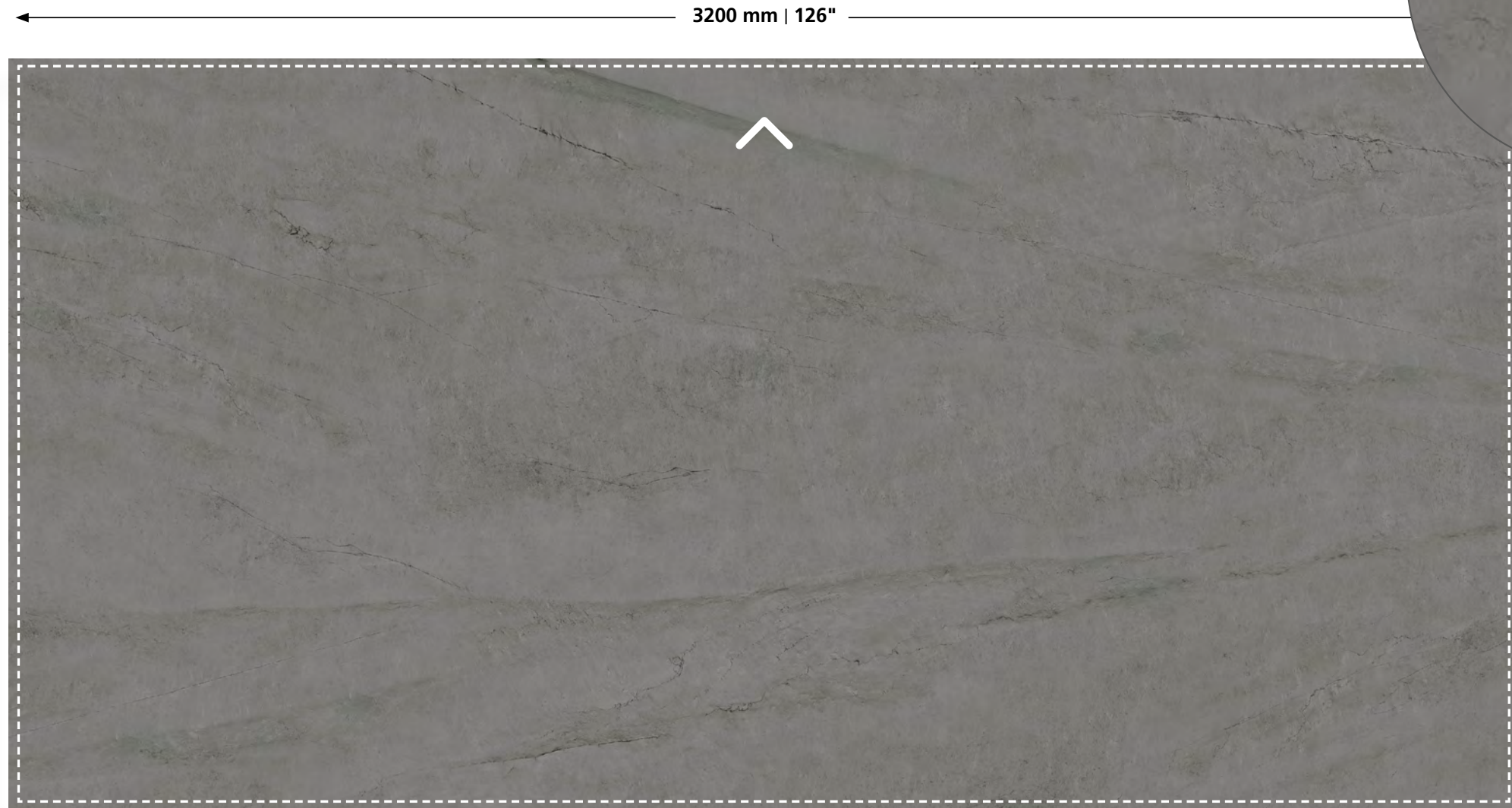

Reduce the 4 sides of the perimeter at a distance of 20-30 mm from the edges to release tension.

The useable slab size after releasing tension is 3160/3140 mm X 1560/1540 mm. (124<sup>3</sup>/<sub>8</sub>"/123<sup>5</sup>/<sub>8</sub>" X 61<sup>1</sup>/<sub>2</sub>"/60<sup>5</sup>/<sub>8</sub>" )

1600 mm | 63"

# 540 Monumental | Pattern continuity plan

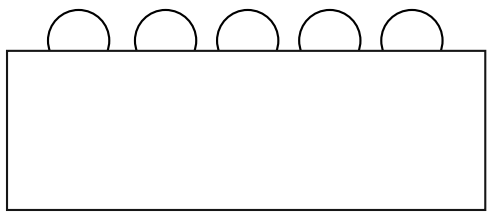

# 540 Monumental | End result

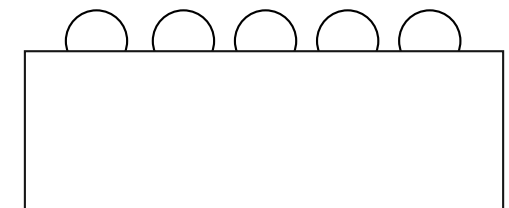

# 540 Monumental | Pattern continuity plan

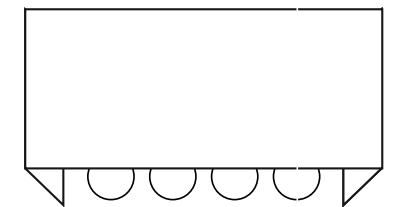
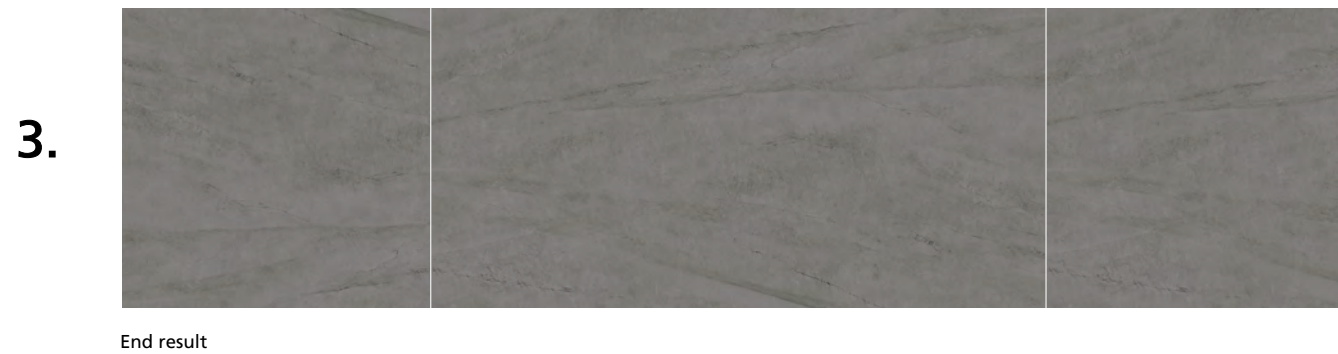
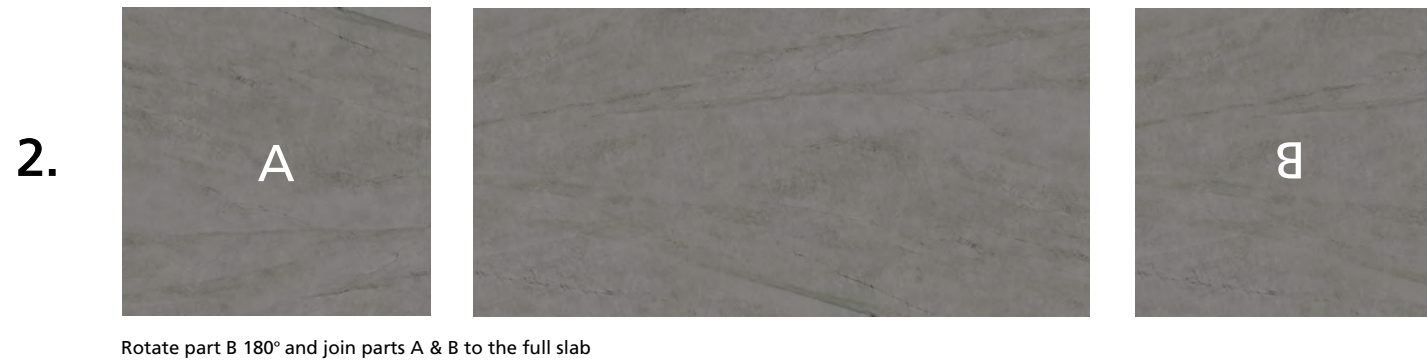

# 540 Monumental | End result

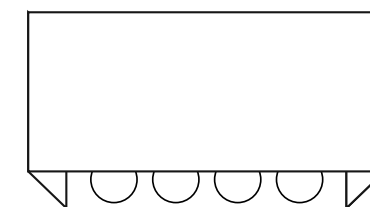
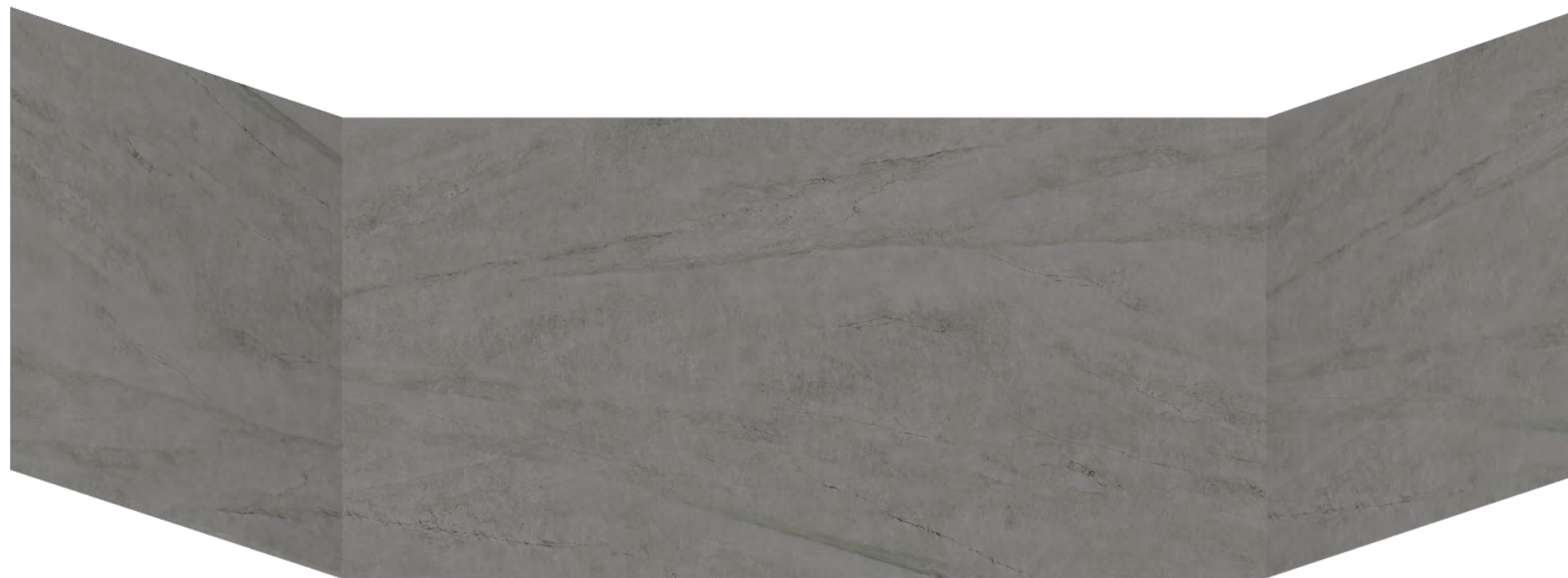

# 540 Monumental | Pattern continuity plan

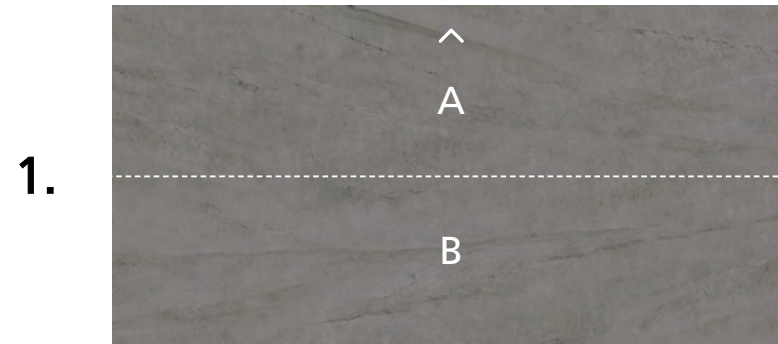

Cut the slab lengthwise

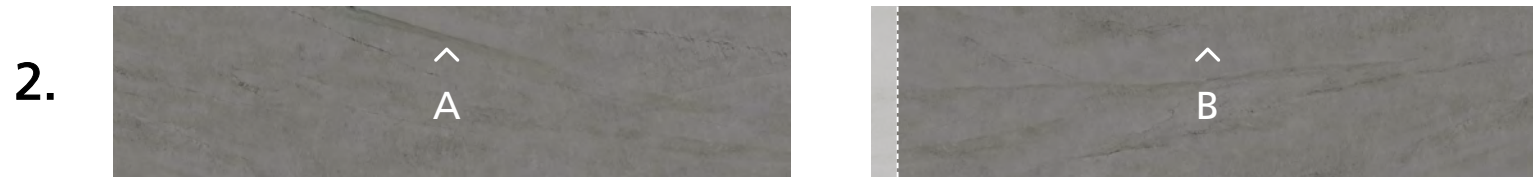

Plan to join parts A & B for continuation of the main veins and remove the surplus



End result

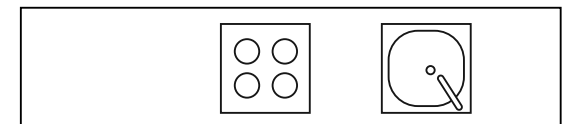

# 540 Monumental | End result

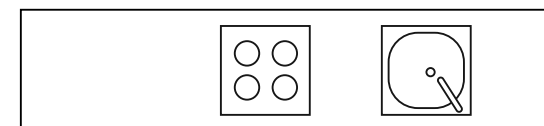
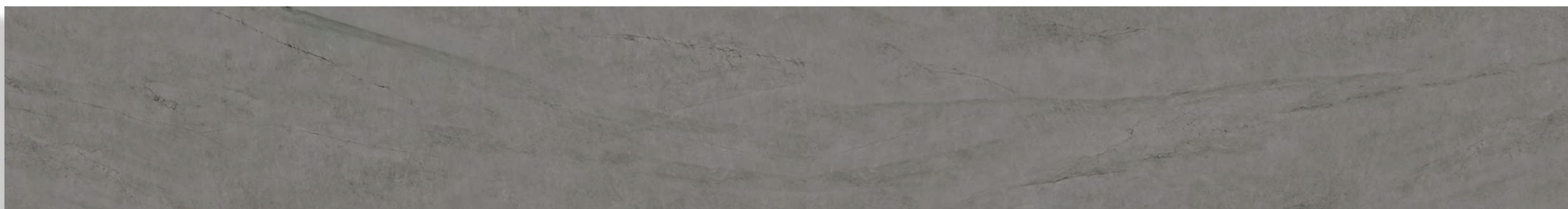

# 540 Monumental | Pattern continuity L-shape

1.

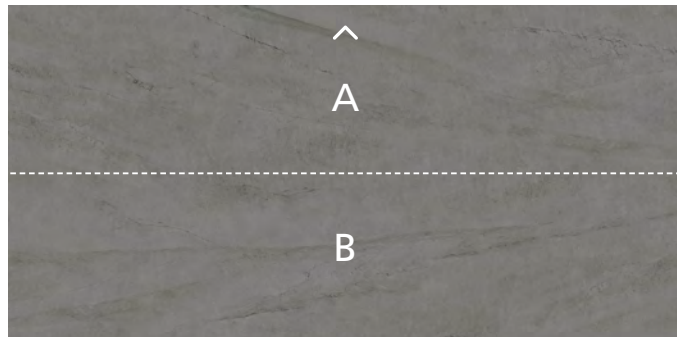

Cut the slab lengthwise

2.

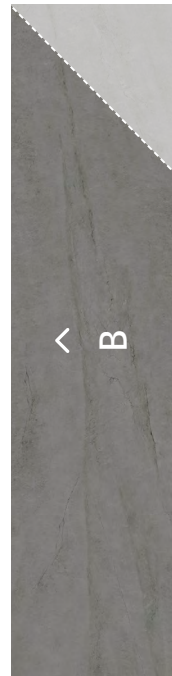
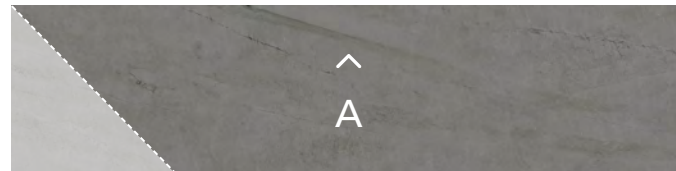

Rotate part B (90°). Join parts A & B and remove the surplus.

3.

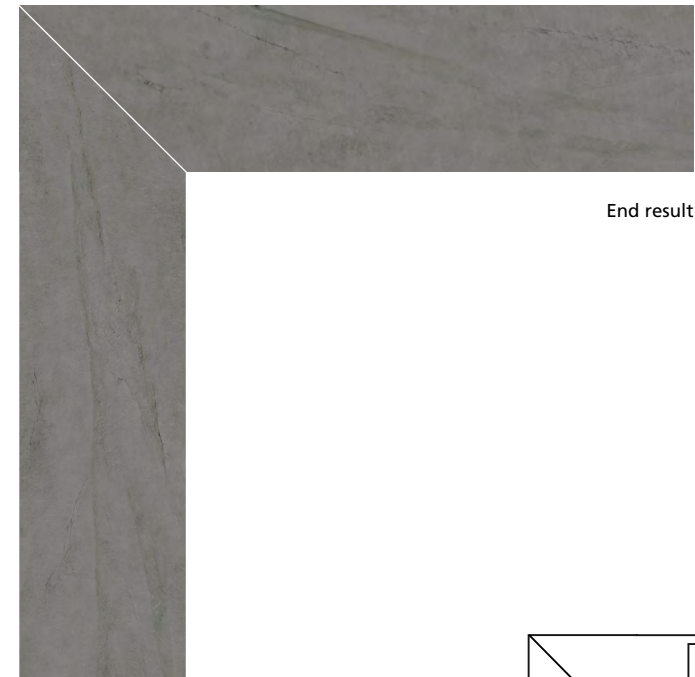

End result

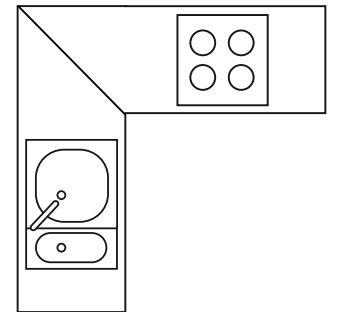

# 540 Monumental | End result

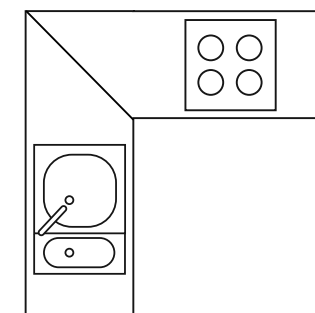

# 540 Monumental | Pattern continuity countertop to backsplash

1.



Cut the slab lengthwise

2.



End result



# 540 Monumental | End result

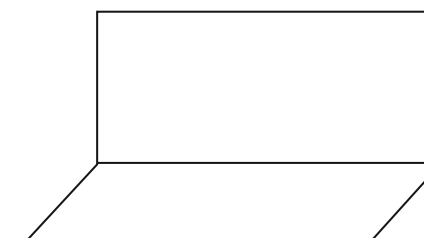

# 542 Mosstone | Releasing slab tension

Full Slab



# 542 Mosstone | Pattern continuity plan

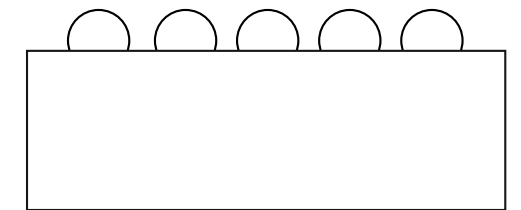

542 Mosstone | End result

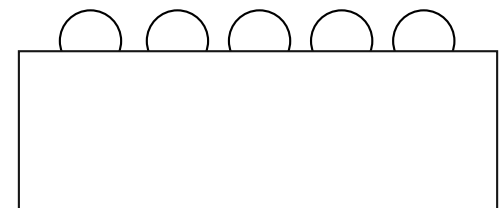

# 542 Mosstone | Pattern continuity plan

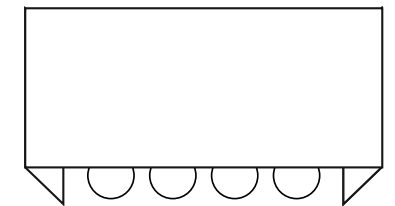
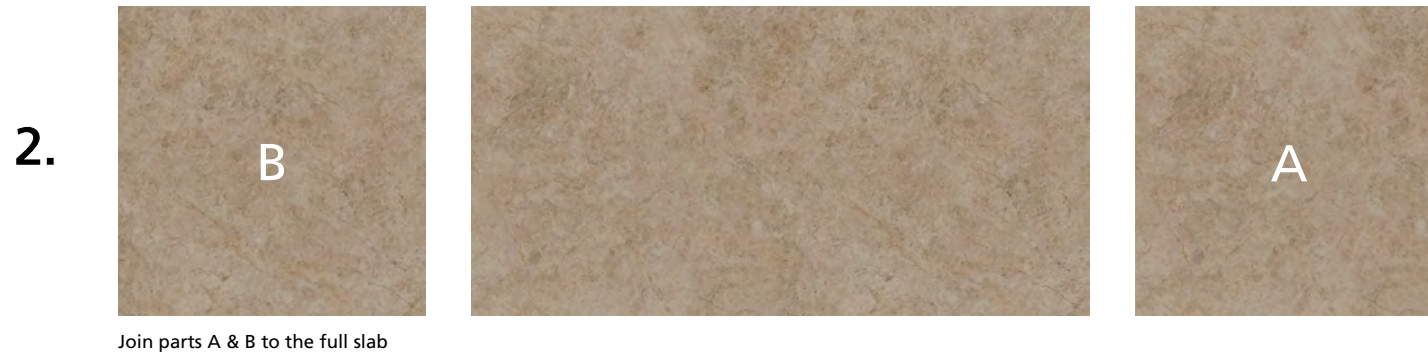

542 Mosstone | End result

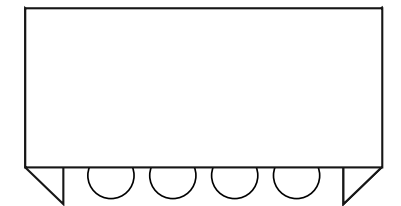
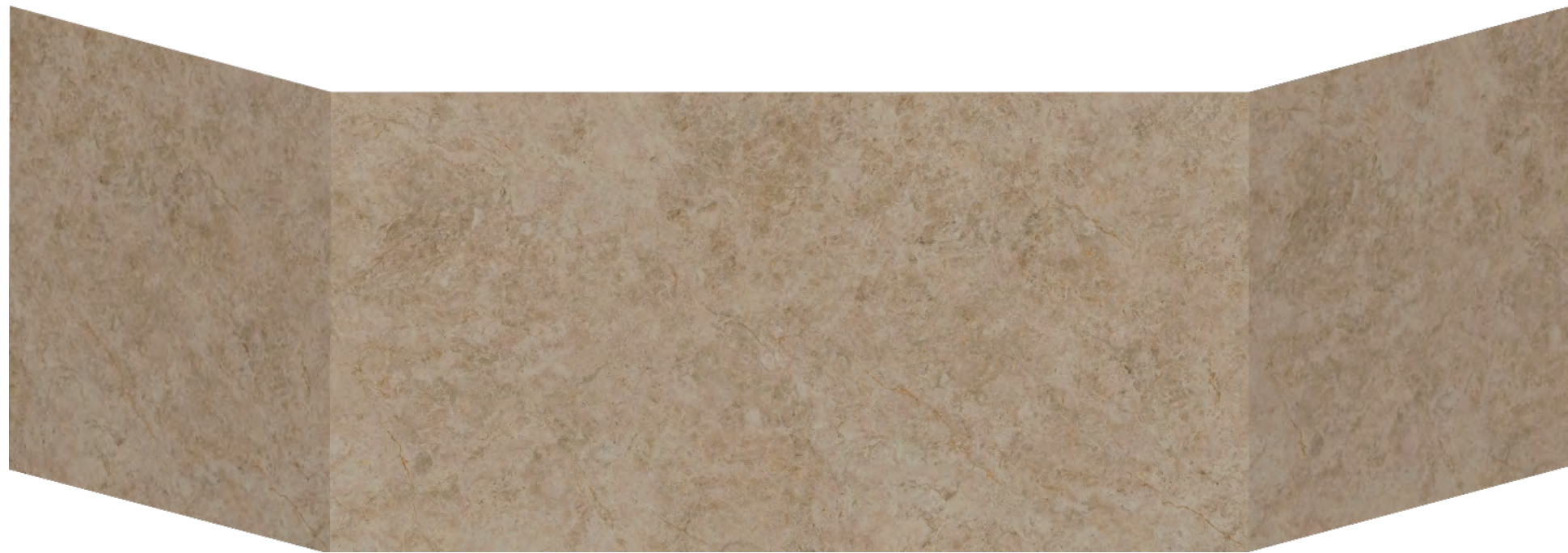

# 542 Mosstone | Pattern continuity plan

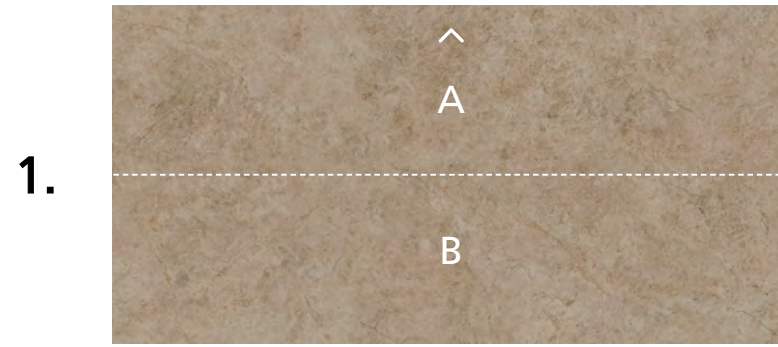

Cut the slab lengthwise

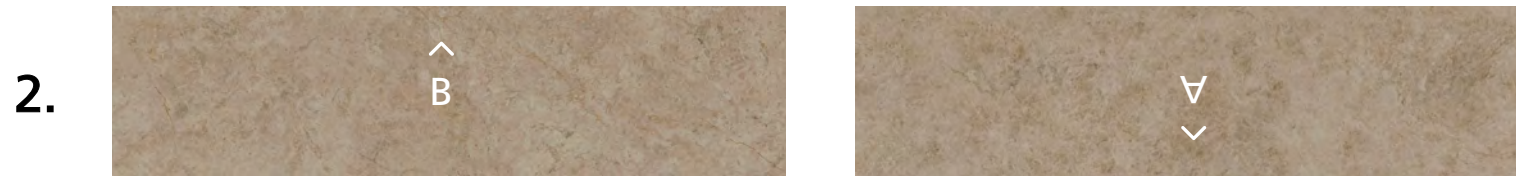

Rotate part A 180° and join parts A & B

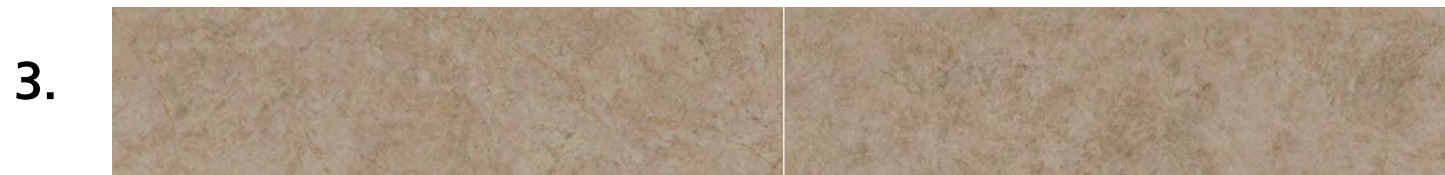

End result

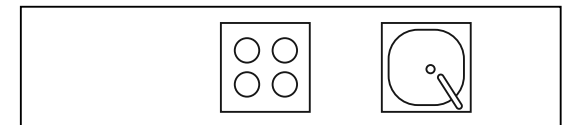

# 542 Mosstone | End result

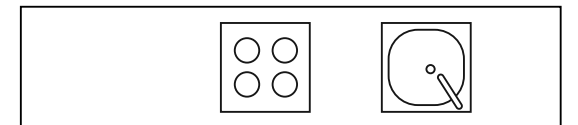

# 542 Mosstone | Pattern continuity L-shape

1.

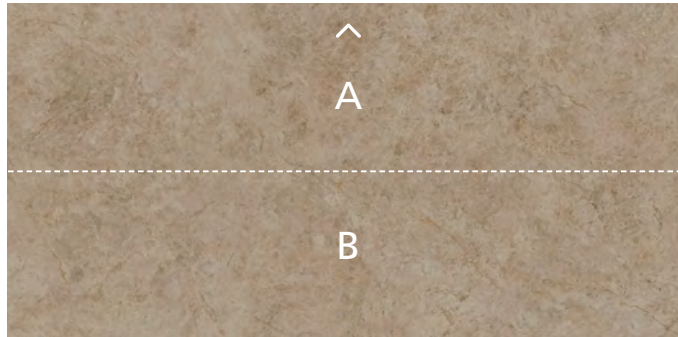

Cut the slab lengthwise

2.

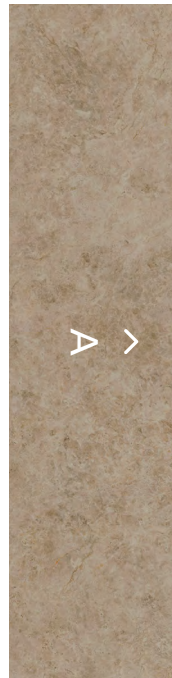
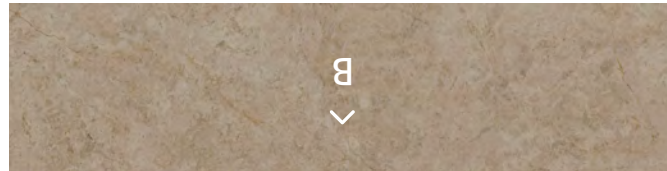

Rotate part B 180°. Rotate part A 90° and join parts A & B.

3.

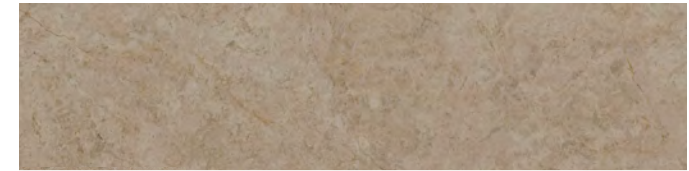

End result

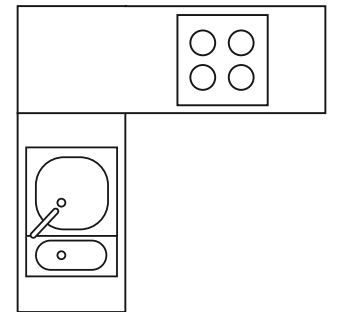

542 Mosstone | End result

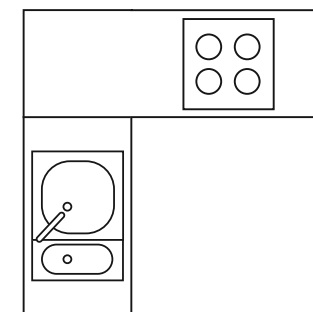

# 542 Mosstone | Pattern continuity countertop to backsplash

1.

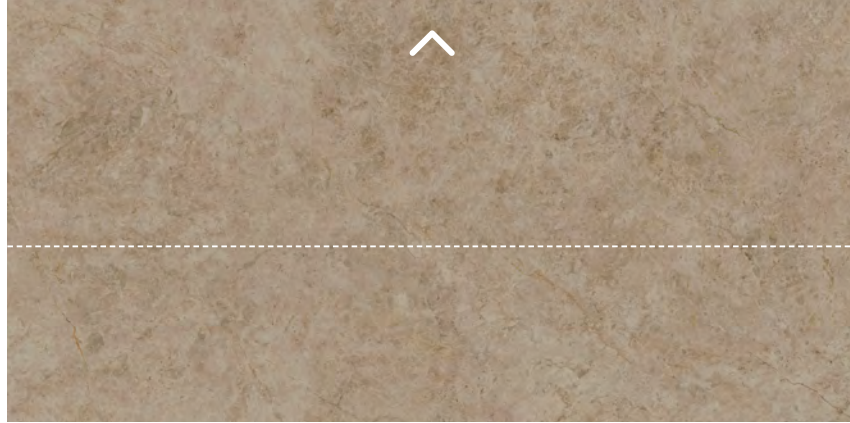

Cut the slab lengthwise

2.



End result



# 542 Mosstone | End result

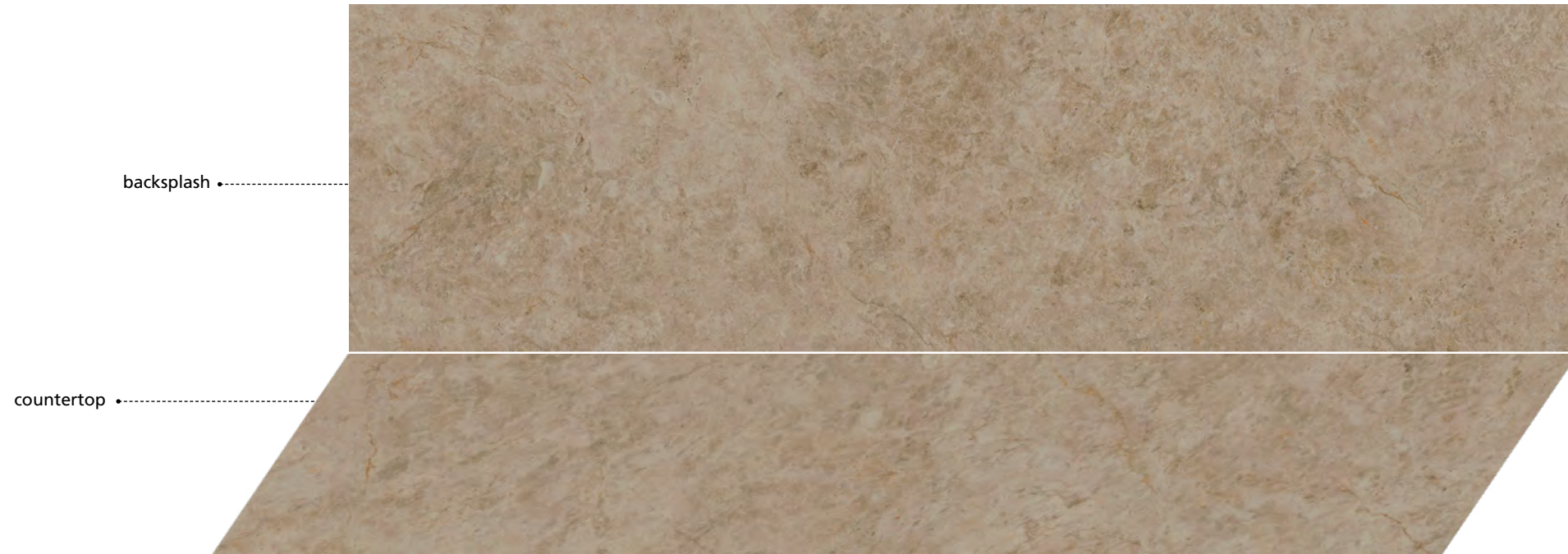

# 543 Marenstone | Releasing slab tension

Full Slab



Reduce the 4 sides of the perimeter at a distance of 20-30 mm from the edges to release tension.

The useable slab size after releasing tension is 3160/3140 mm X 1560/1540 mm. (124<sup>3/8</sup>"/123<sup>5/8</sup>" X 61<sup>1/2</sup>"/60<sup>5/8</sup>" )

# 543 Marenstone | Pattern continuity plan

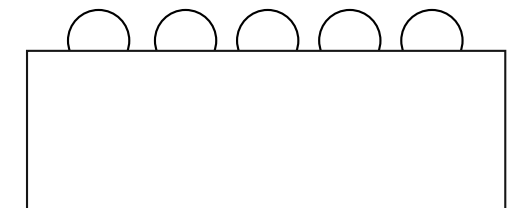
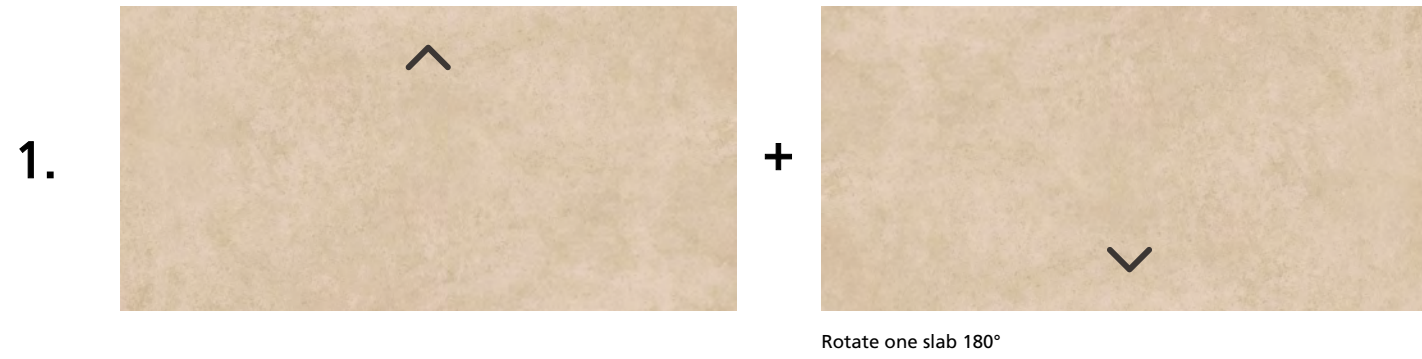

543 Marenstone | End result

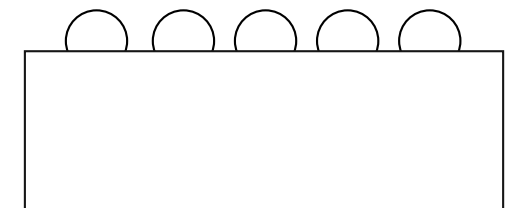

# 543 Marenstone | Pattern continuity plan

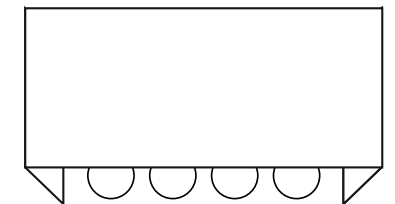
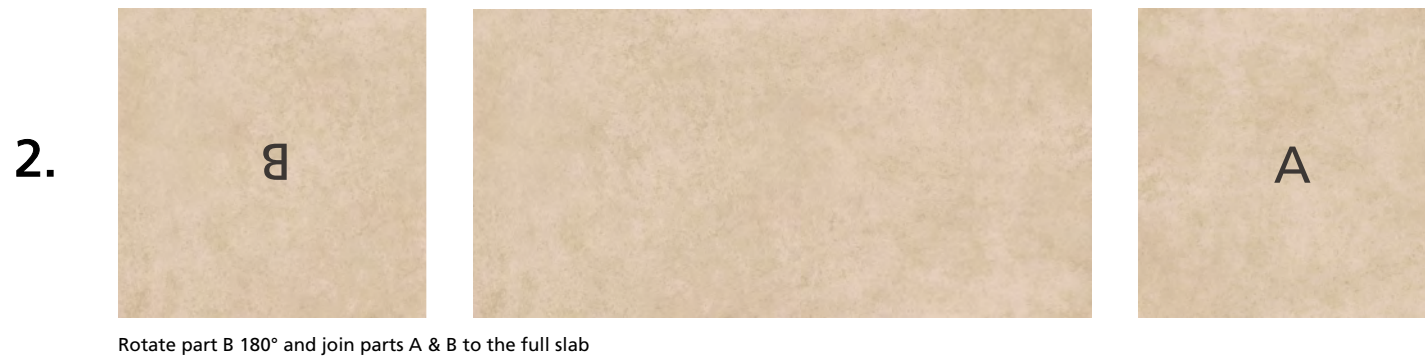
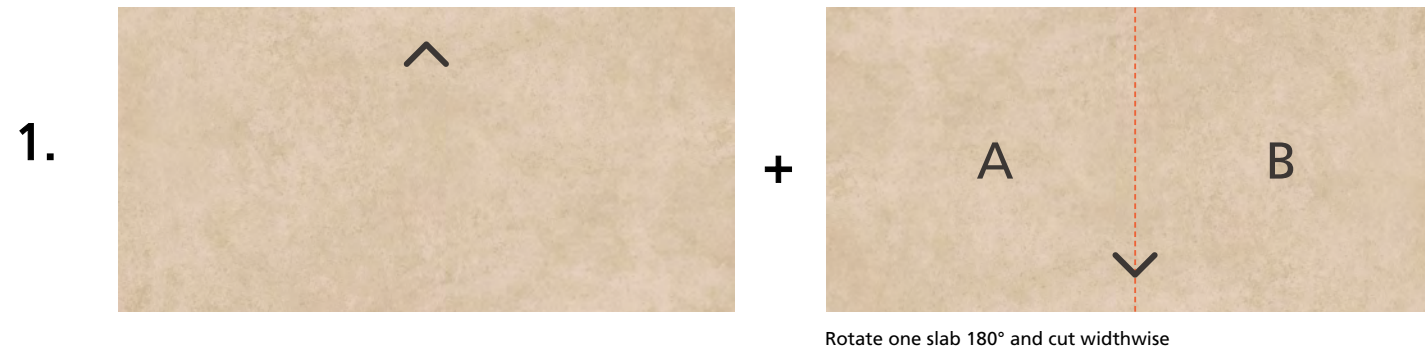

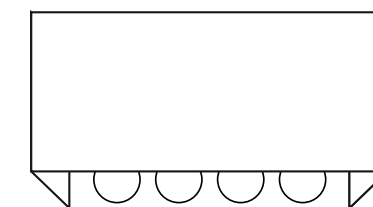
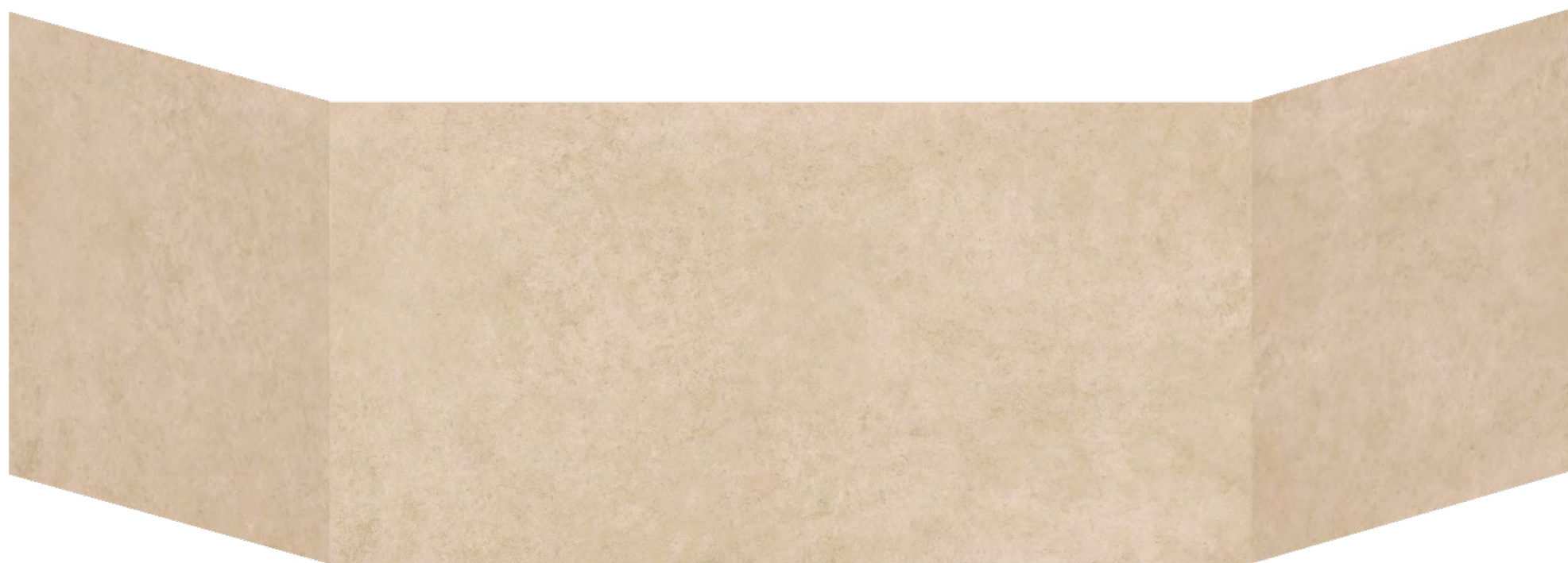

# 543 Marenstone | Pattern continuity plan

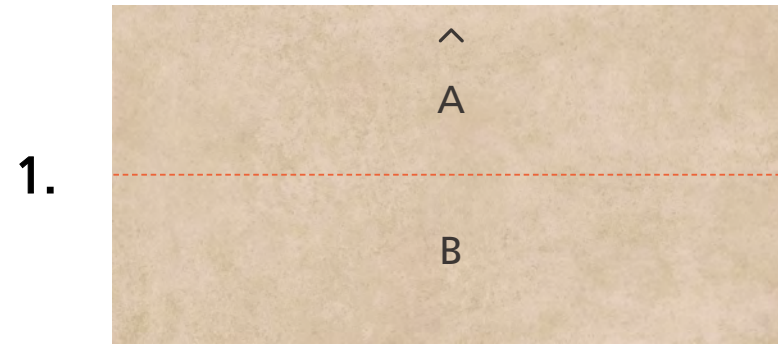

Cut the slab lengthwise

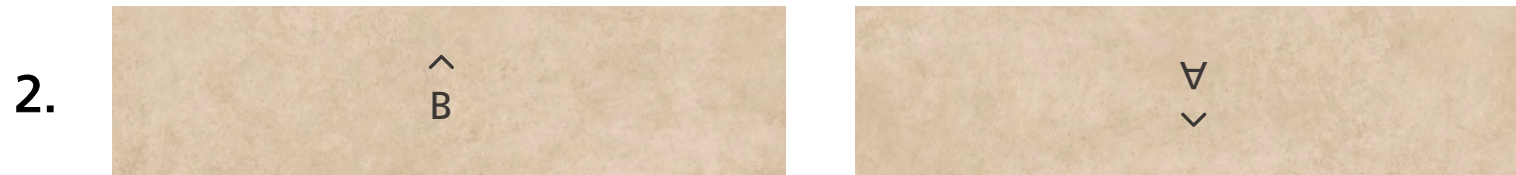

Rotate part A 180° and join parts A & B

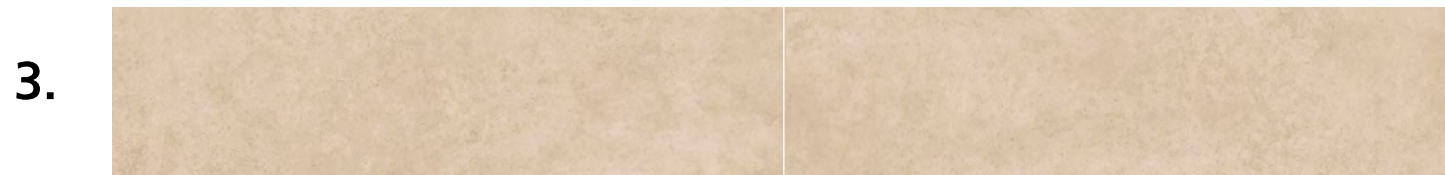

End result

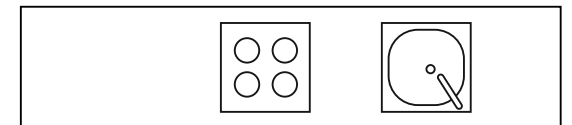

# 543 Marenstone | End result

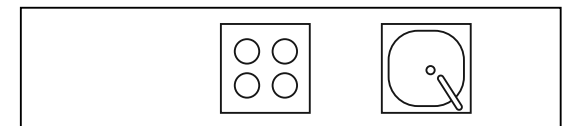

# 543 Marenstone | Pattern continuity L-shape

1.

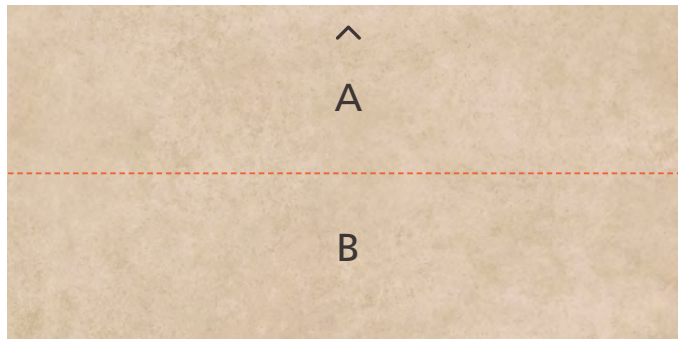

Cut the slab lengthwise

2.

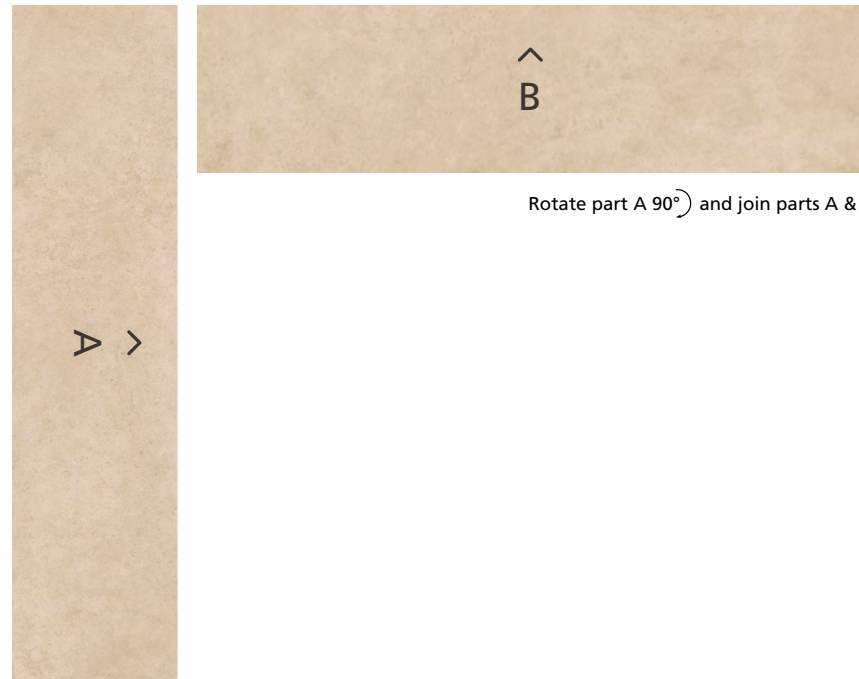

3.

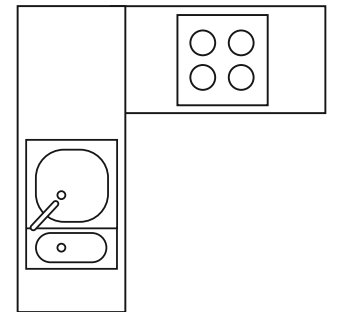
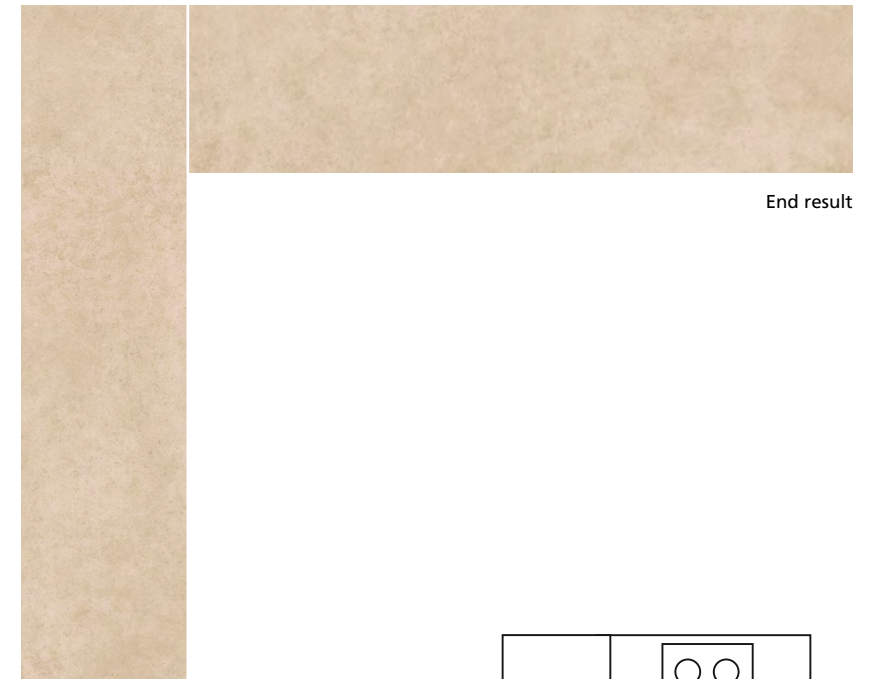

543 Marenstone | End result

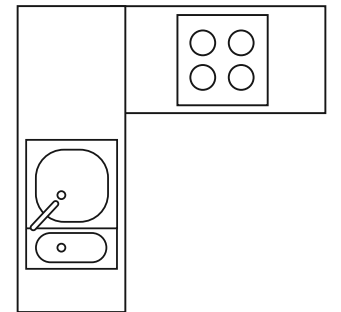

# 543 Marenstone | Pattern continuity countertop to backsplash

1.

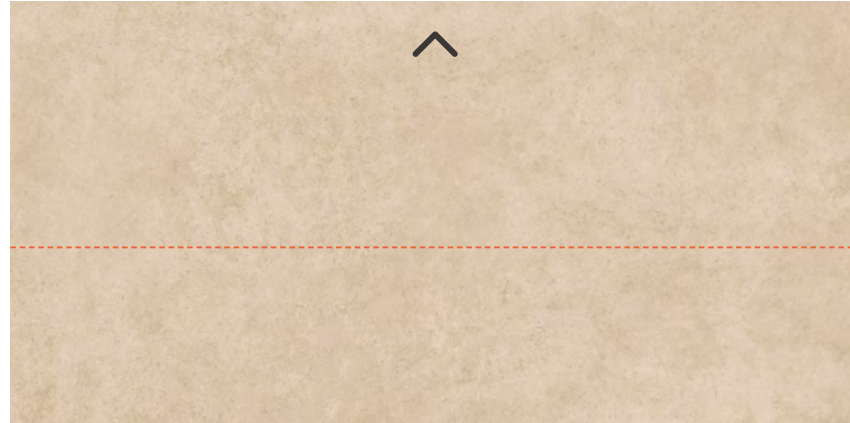

Cut the slab lengthwise

2.



End result



# 543 Marenstone | End result

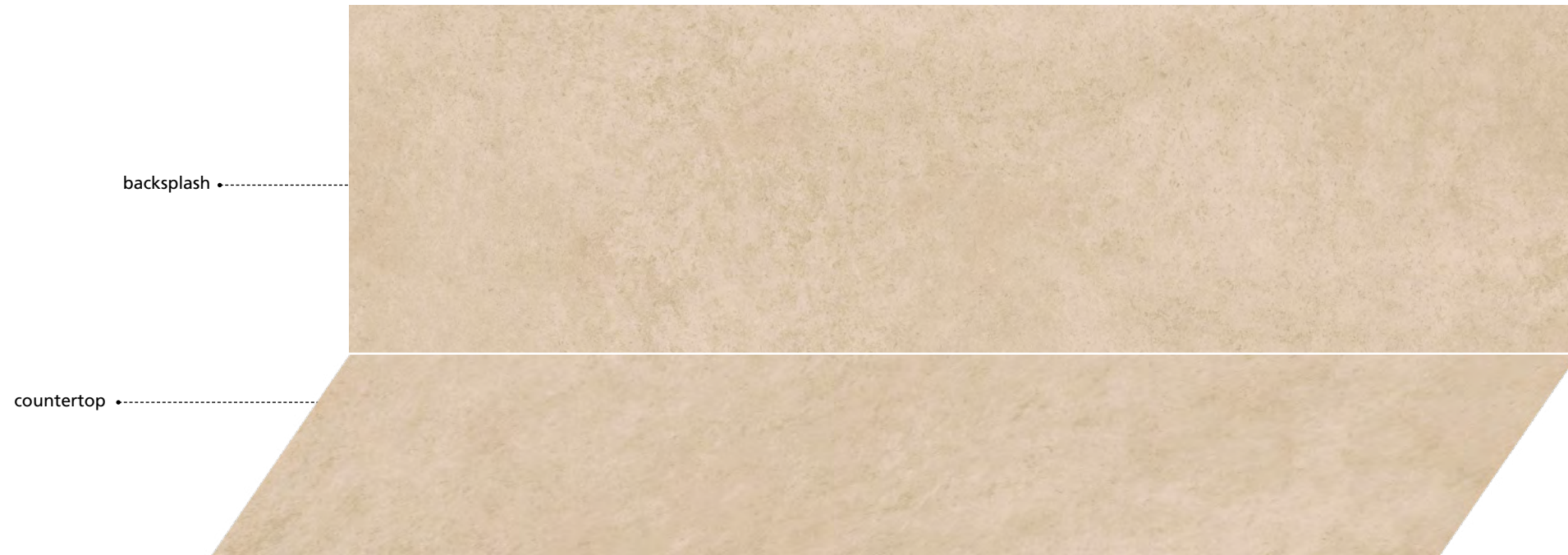

# 544 Auralux | Releasing slab tension

Full Slab



Reduce the 4 sides of the perimeter at a distance of 20-30 mm from the edges to release tension.

The useable slab size after releasing tension is 3160/3140 mm X 1560/1540 mm. (124<sup>3</sup>/<sub>8</sub>"/123<sup>5</sup>/<sub>8</sub>" X 61<sup>1</sup>/<sub>2</sub>"/60<sup>5</sup>/<sub>8</sub>" )

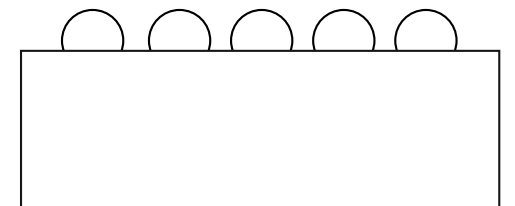
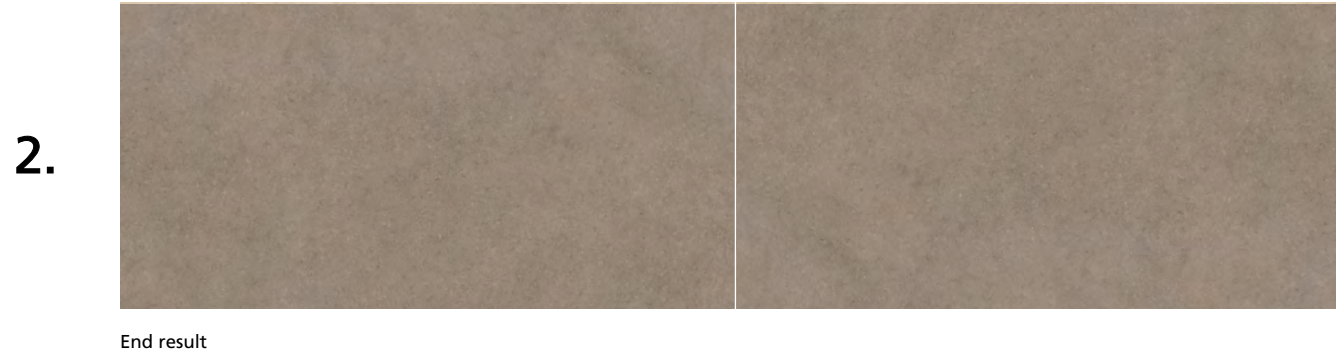
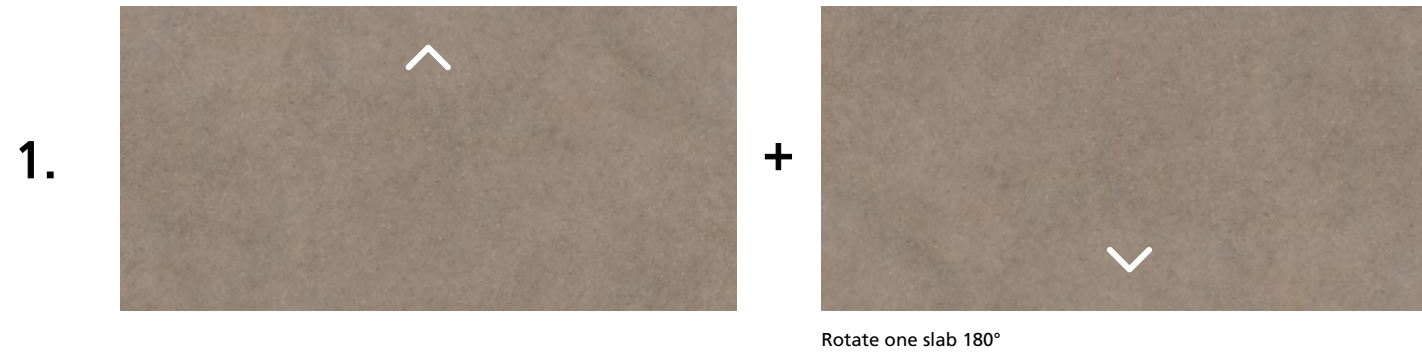

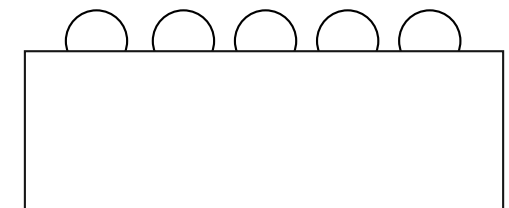

# 544 Auralux | Pattern continuity plan

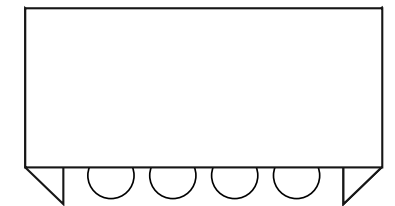
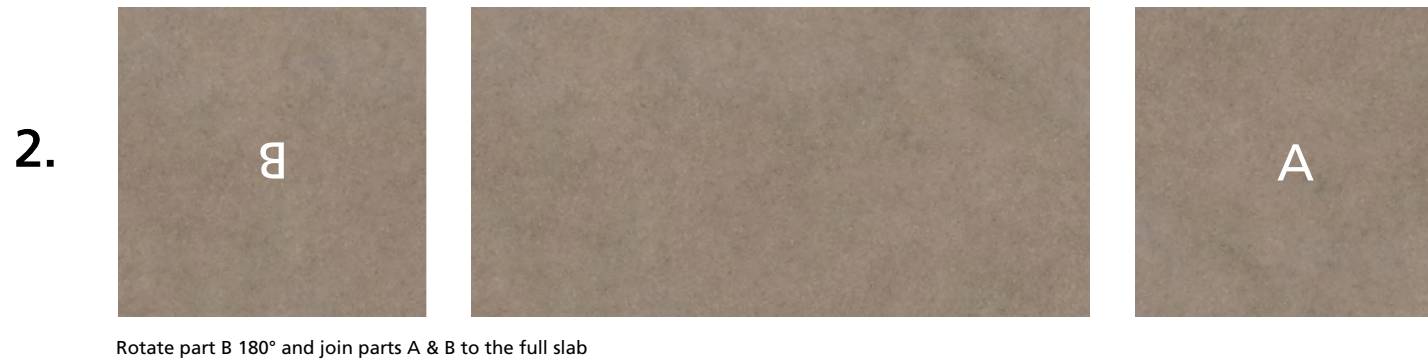
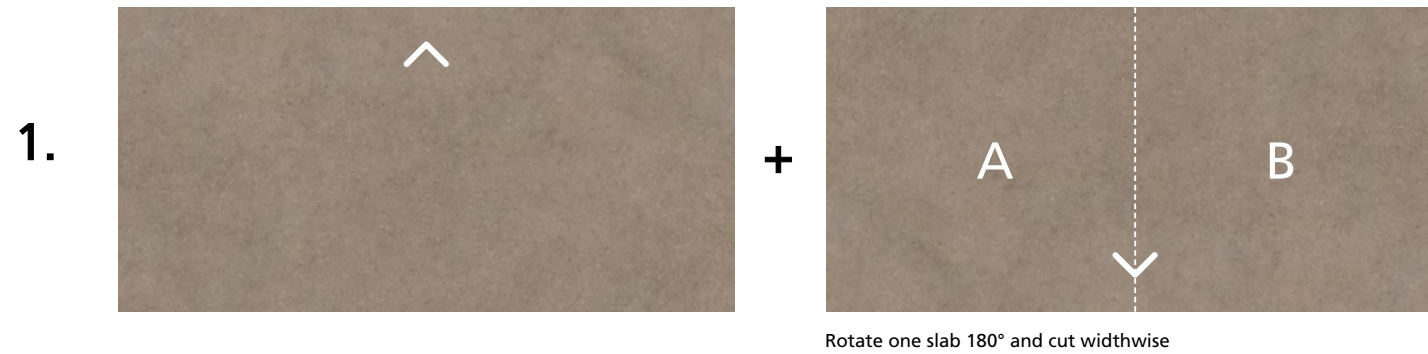

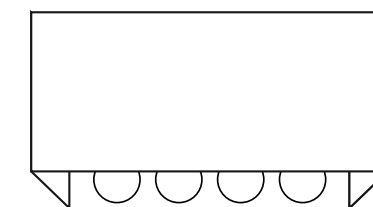
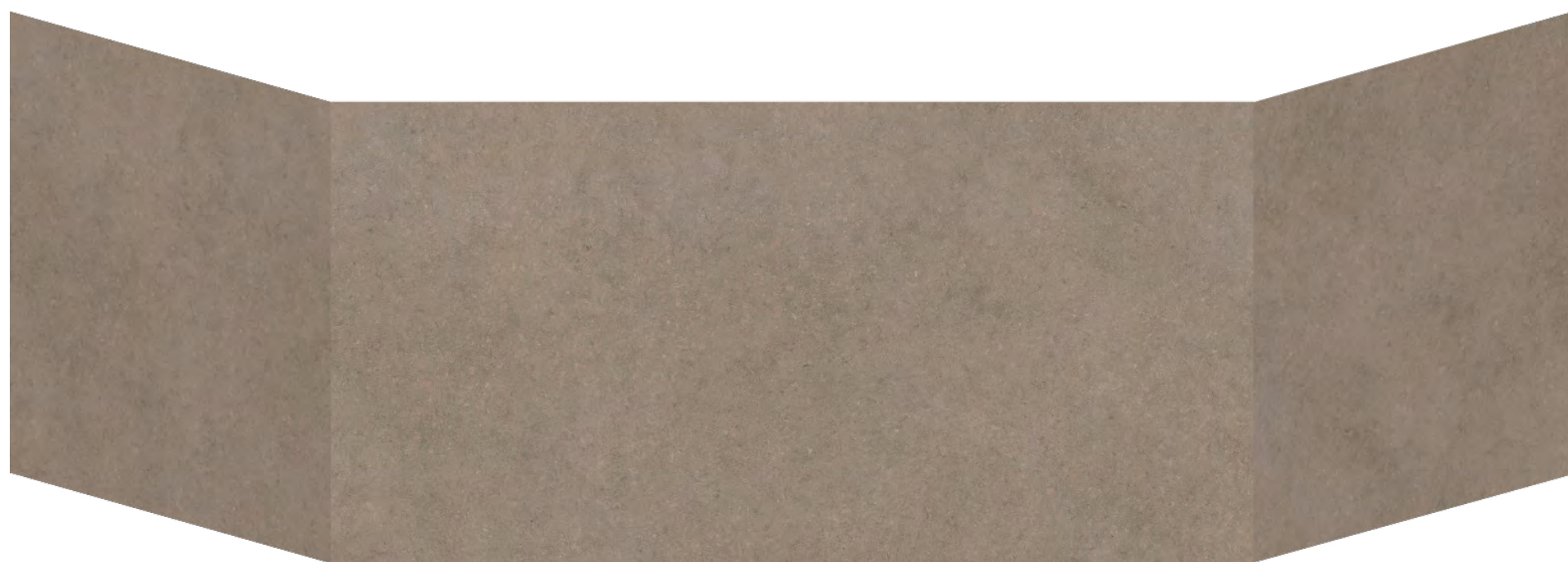

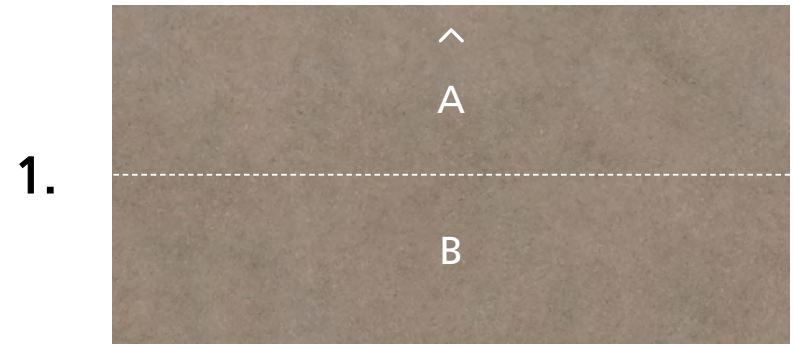

Cut the slab lengthwise



Rotate part A 180° and join parts A & B



End result

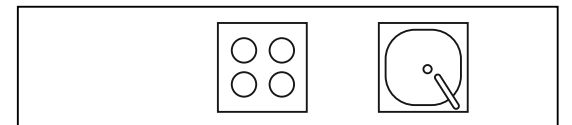

544 Auralux | End result

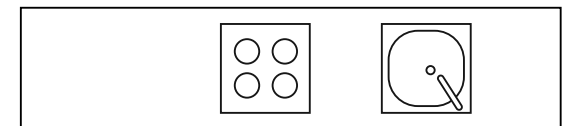

1.

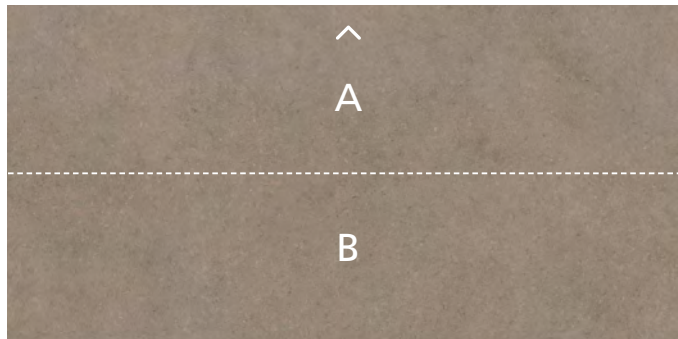

Cut the slab lengthwise

2.

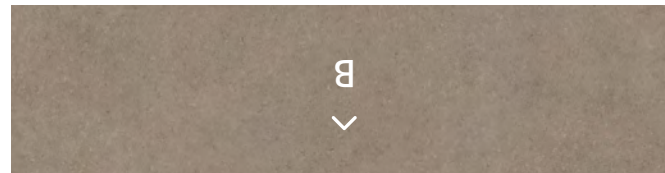

Rotate part A 90°. Rotate part B 180° and join parts A & B.

3.

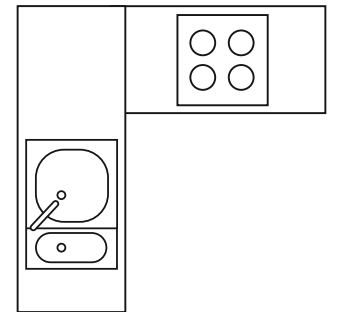

544 Auralux | End result

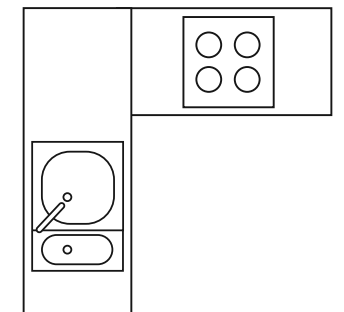

544 Auralux | Pattern continuity countertop to backsplash

1.

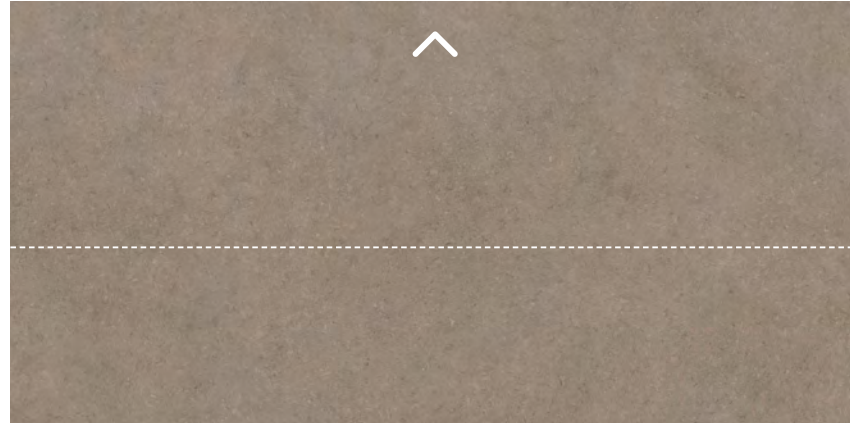

Cut the slab lengthwise

2.

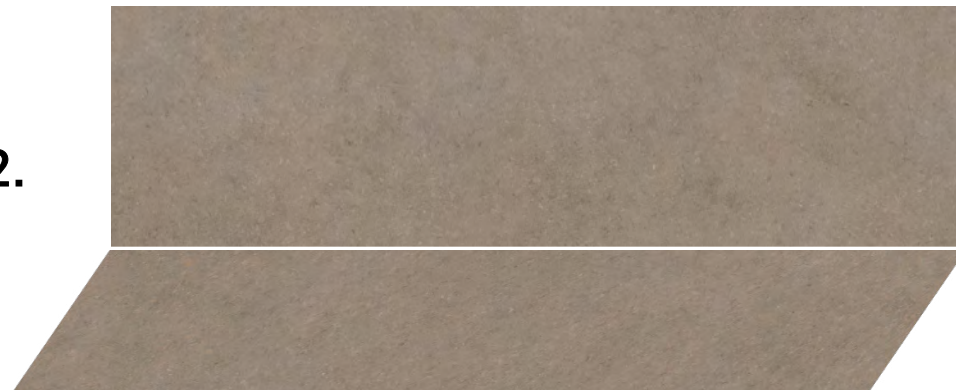

End result



# 544 Auralux | End result



# 550 Silvax | Releasing slab tension

Full Slab





End result

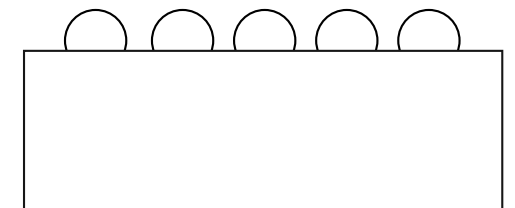

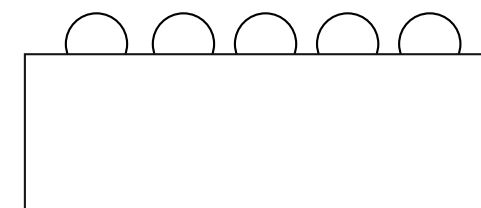

# 550 Silvax | Pattern continuity plan

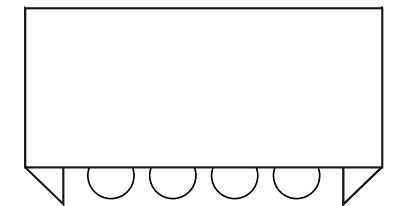
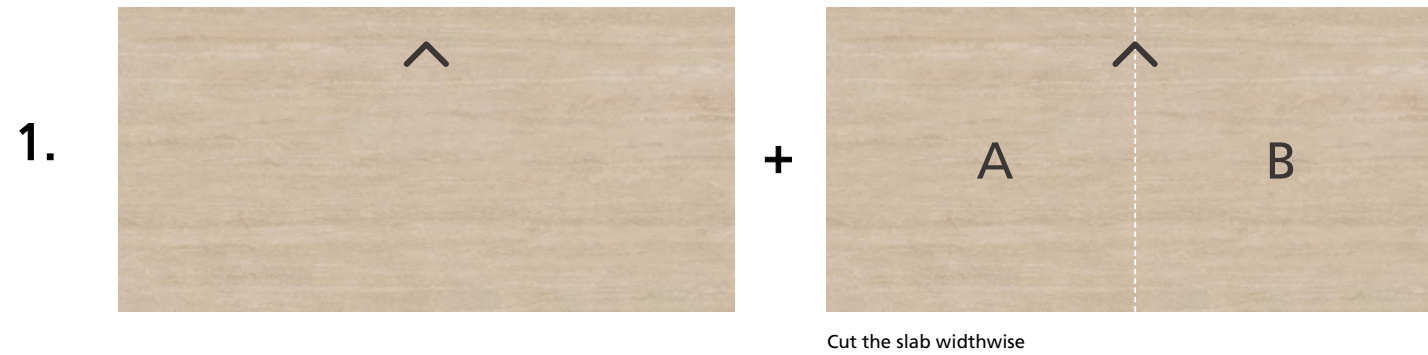

550 Silvax | End result

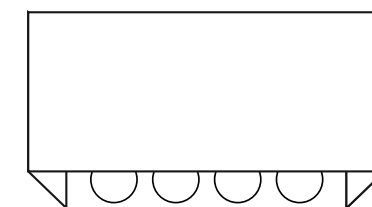
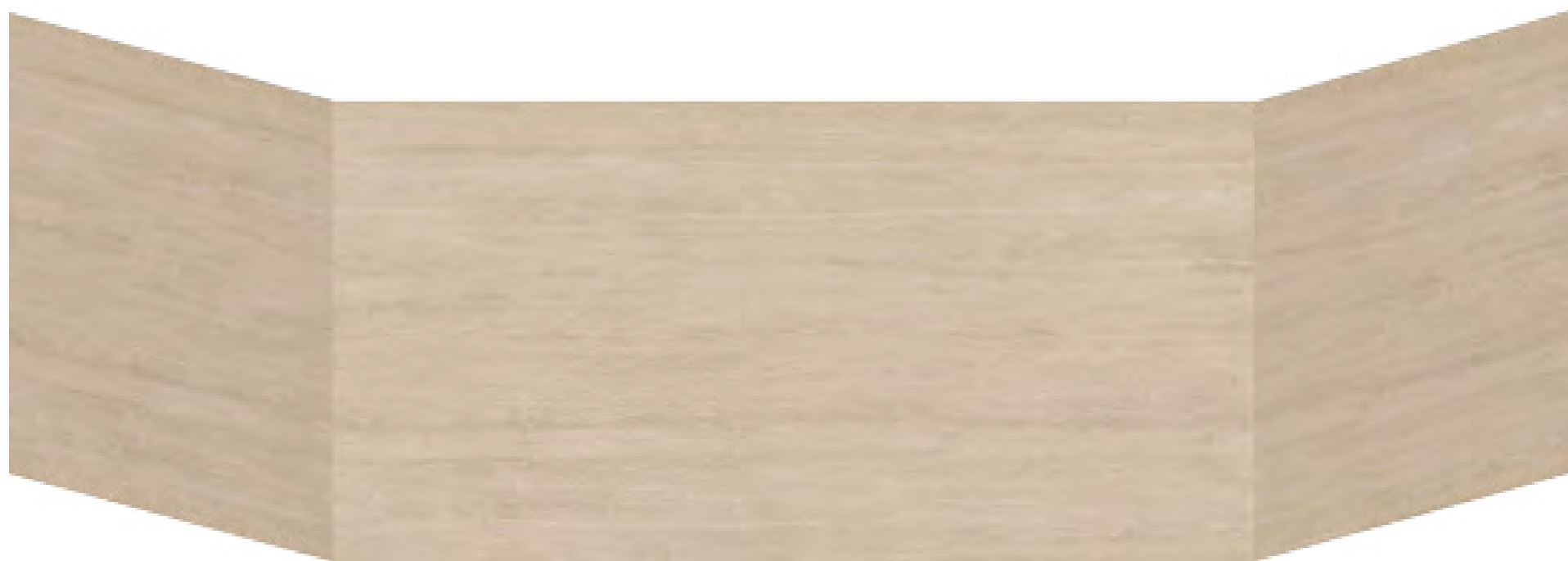

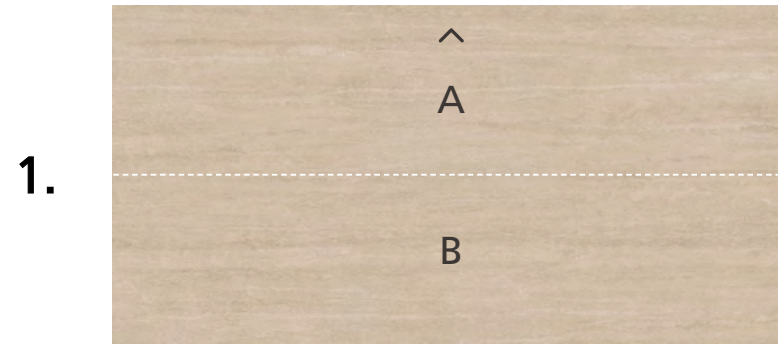

Cut the slab lengthwise



Rotate part A 180° and join parts A & B

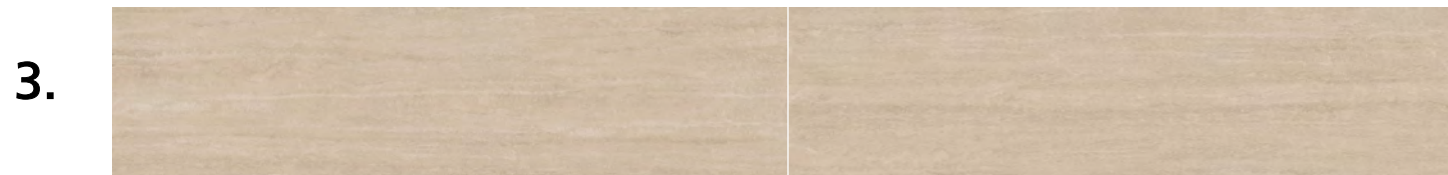

End result

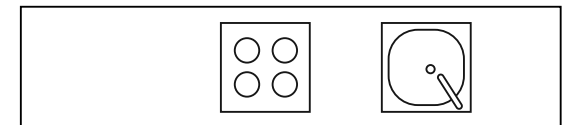

# 550 Silvax | End result

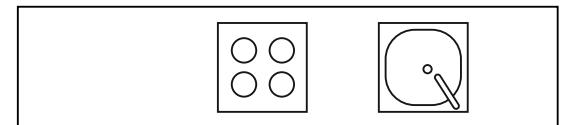

# 550 Silvax | Pattern continuity L-shape

1.

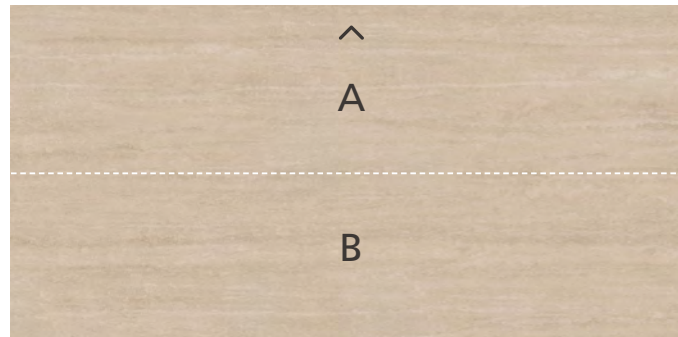

Cut the slab lengthwise

2.

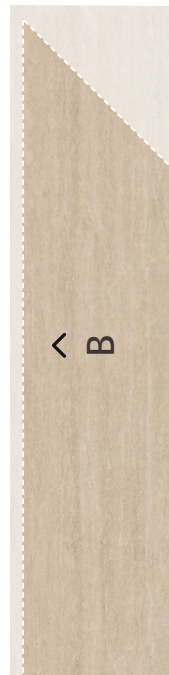
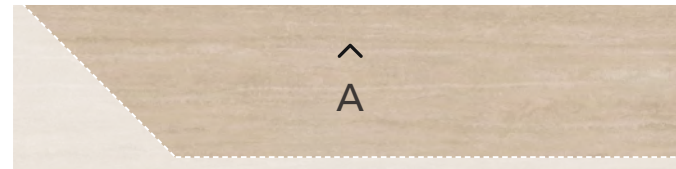

Rotate part B (90°. Plan to join parts A & B for pattern continuity and remove the surplus.

3.

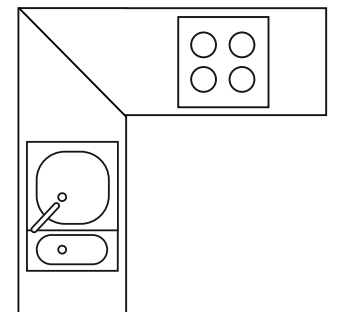
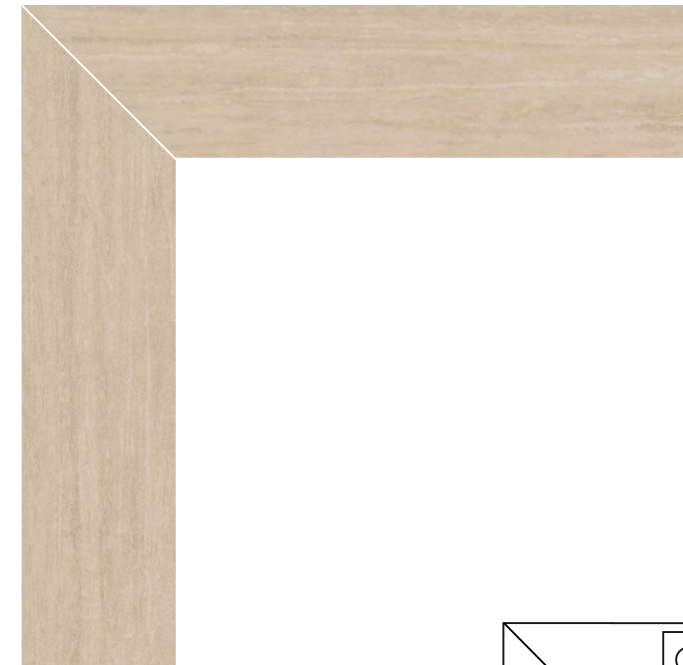

550 Silvax | End result

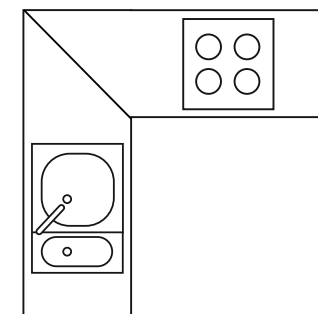

# 550 Silvax | Pattern continuity countertop to backsplash

1.

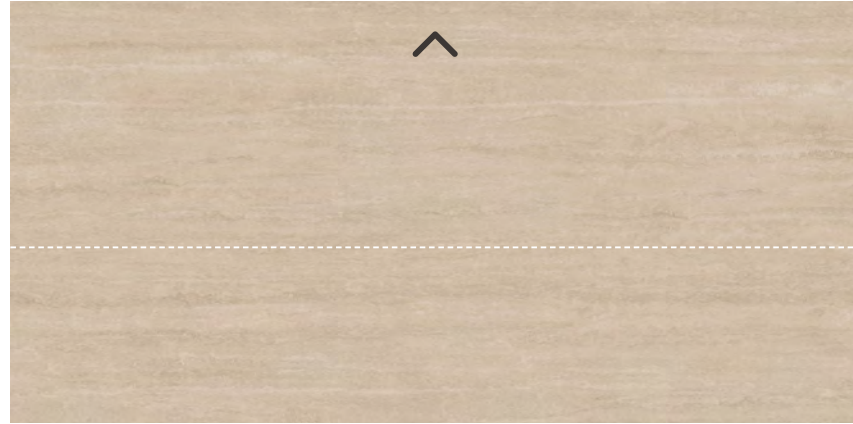

Cut the slab lengthwise

2.



End result



# 550 Silvax | End result

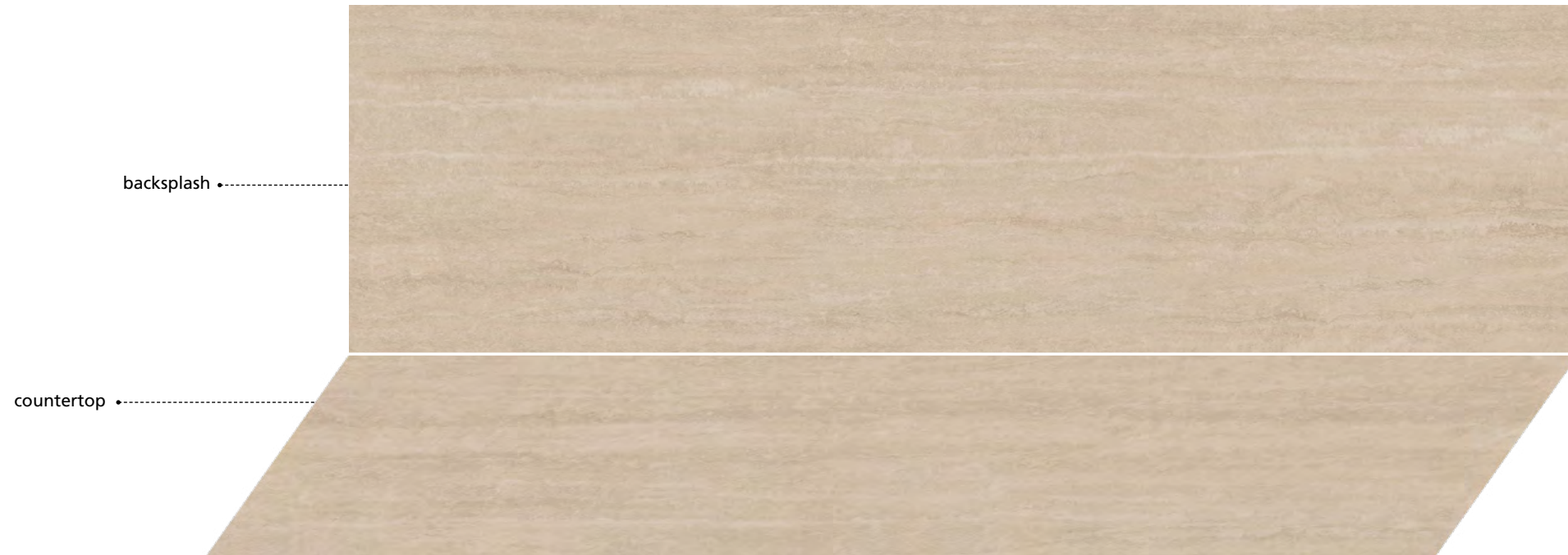

# 580 Fume | Releasing slab tension

Full Slab



# 580 Fume | Pattern continuity plan

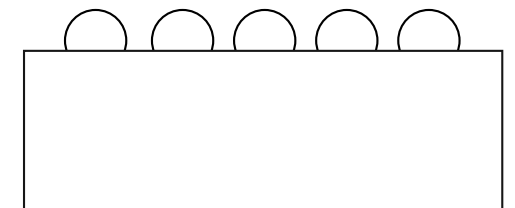
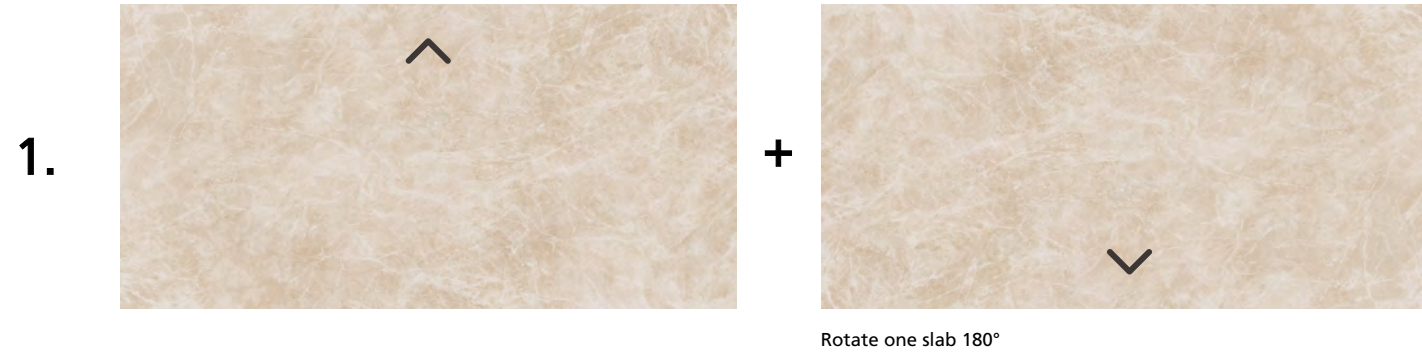

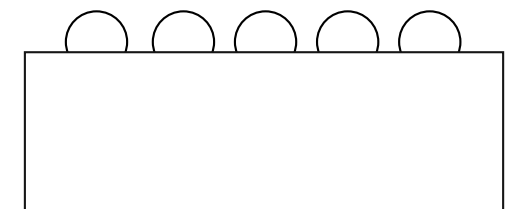

# 580 Fume | Pattern continuity plan

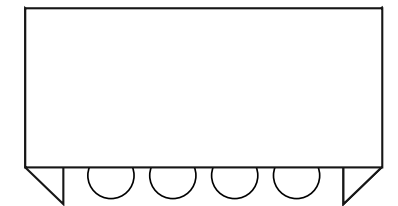
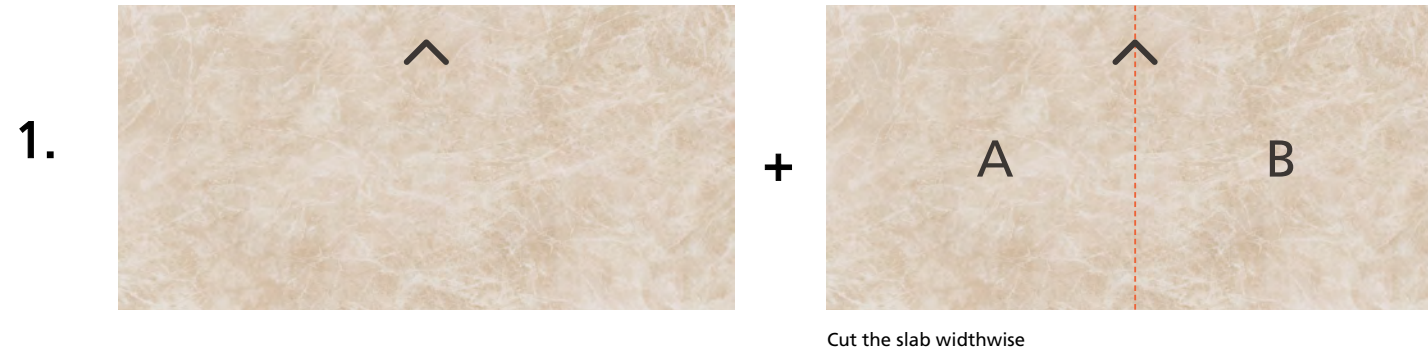

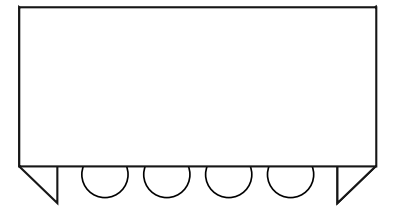
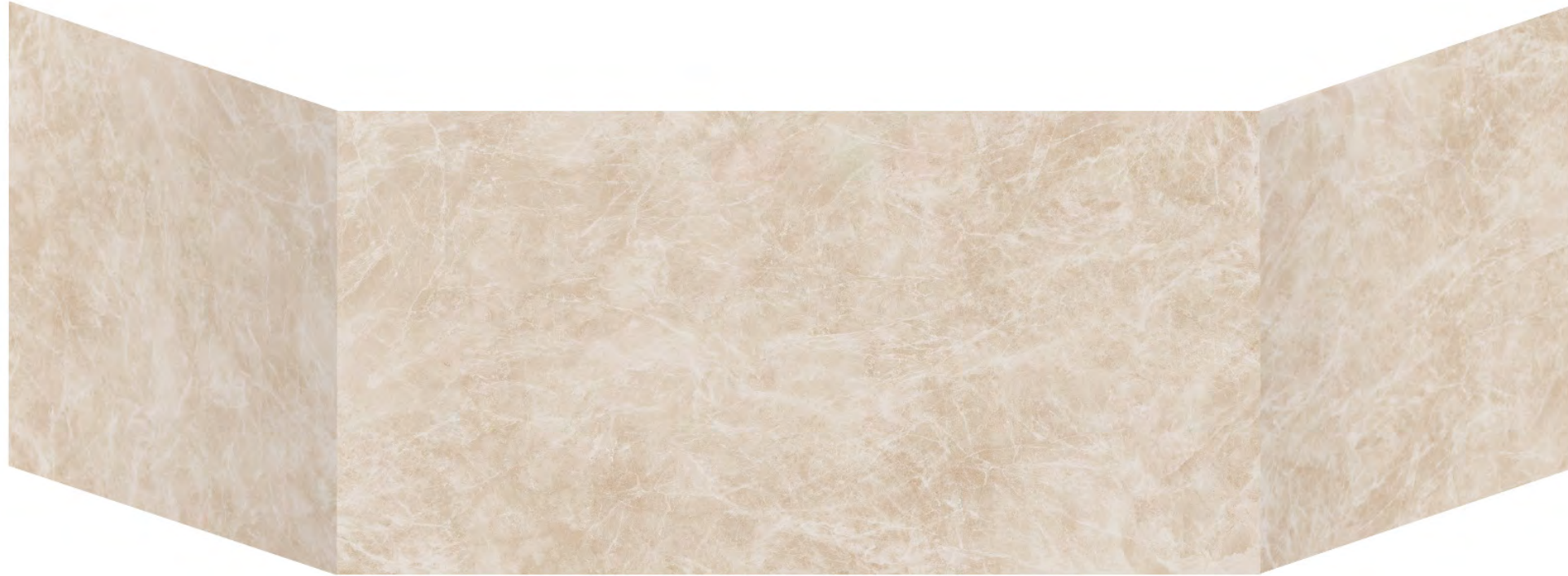

# 580 Fume | Pattern continuity plan

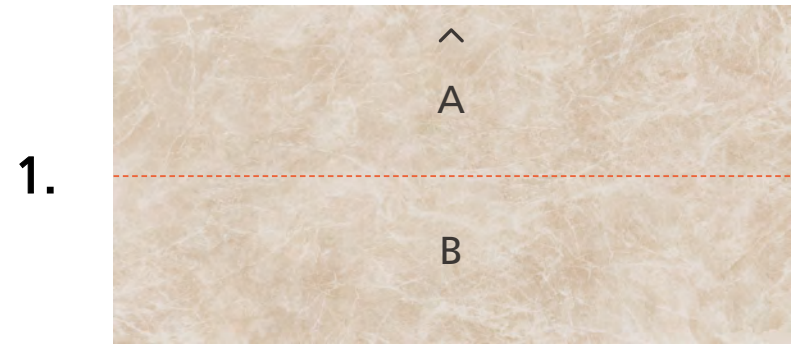

Cut the slab lengthwise

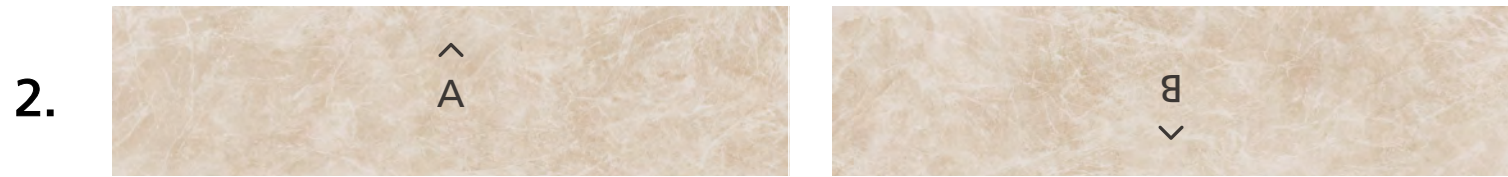

Rotate part B 180° and join parts A & B

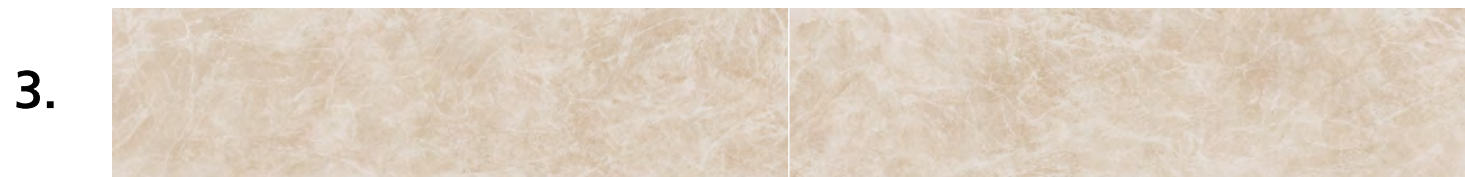

End result

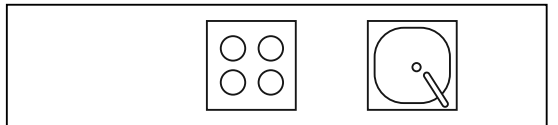

# 580 Fume | End result

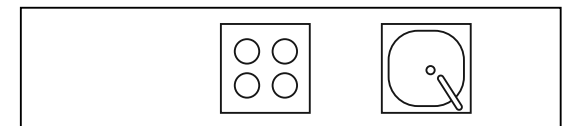

1.

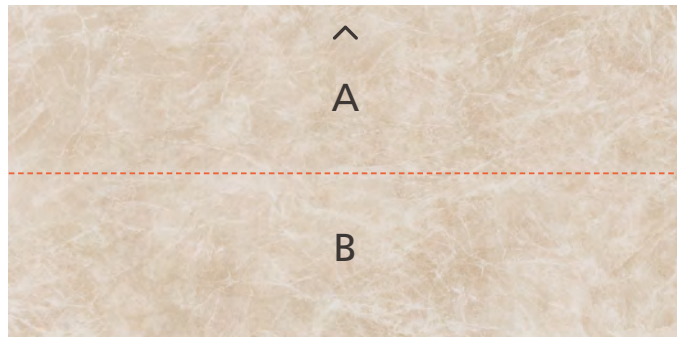

Cut the slab lengthwise

2.

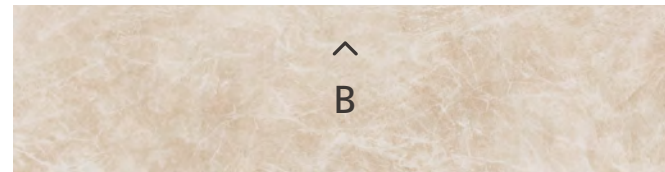

Rotate part A (90° and join parts A & B

3.



End result

580 Fume | End result

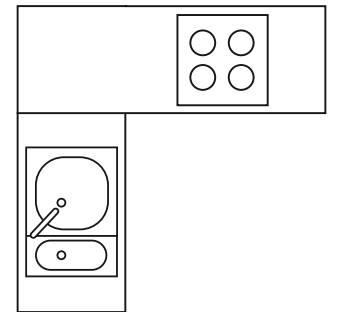

# 580 Fume | Pattern continuity countertop to backsplash

1.



Cut the slab lengthwise

2.



End result



# 580 Fume | End result

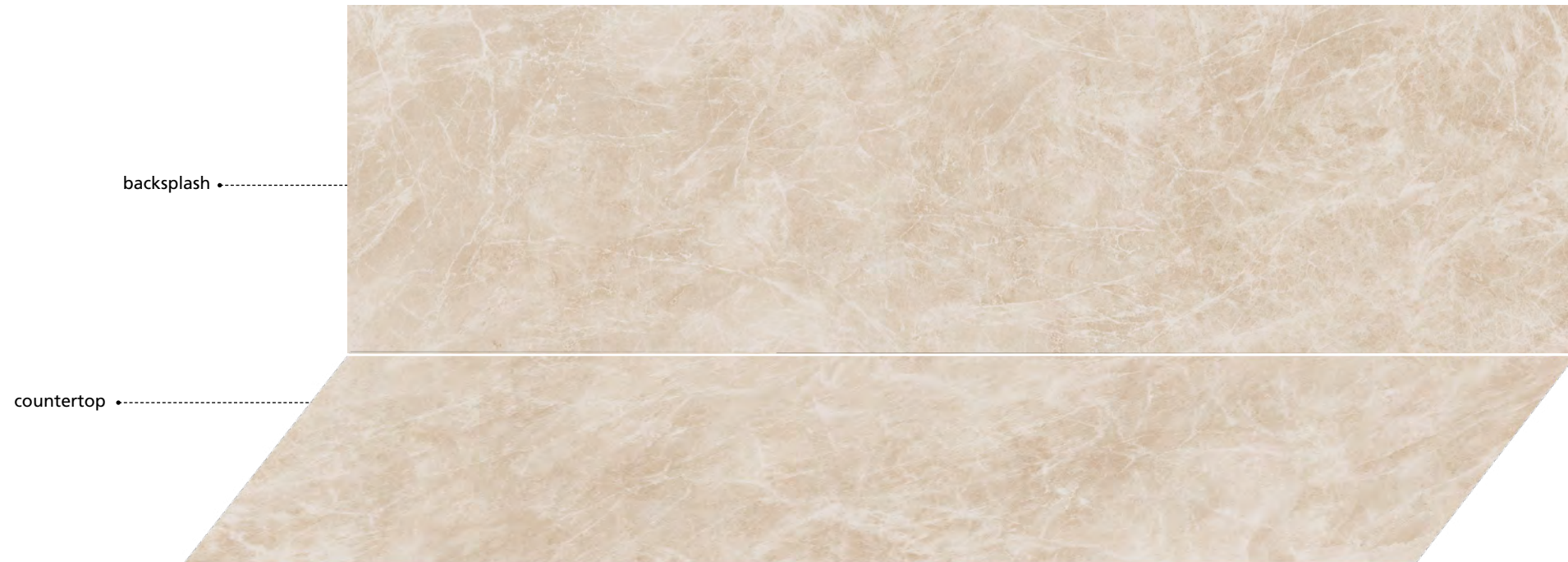

# 581 Lucillia | Releasing slab tension

Full Slab

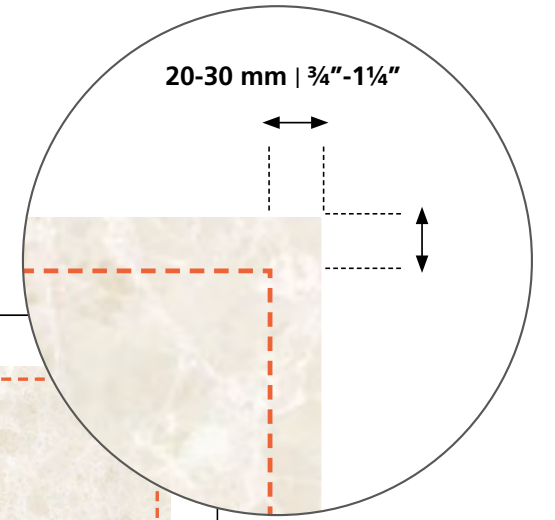

Reduce the 4 sides of the perimeter at a distance of 20-30 mm from the edges to release tension.

The useable slab size after releasing tension is 3160/3140 mm X 1560/1540 mm. (124<sup>3</sup>/<sub>8</sub>"/123<sup>5</sup>/<sub>8</sub>" X 61<sup>1</sup>/<sub>2</sub>"/60<sup>5</sup>/<sub>8</sub>" )

# 581 Lucillia | Pattern continuity plan

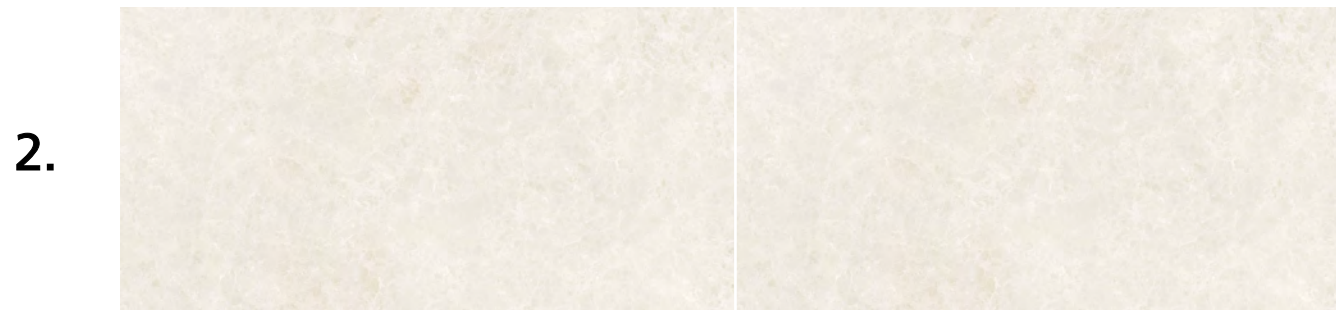
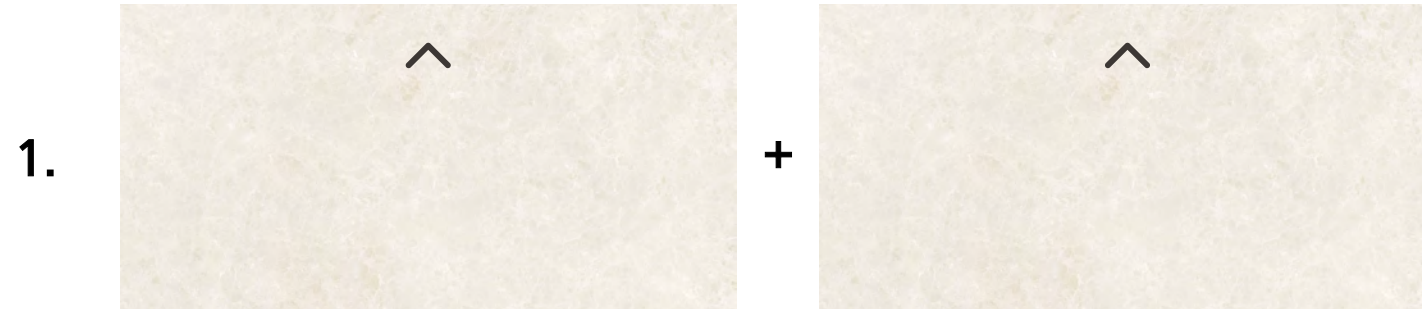

End result

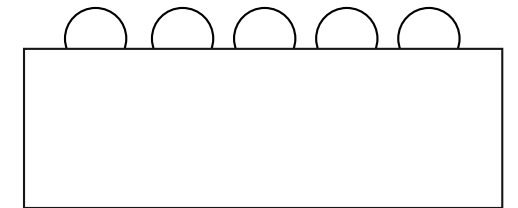

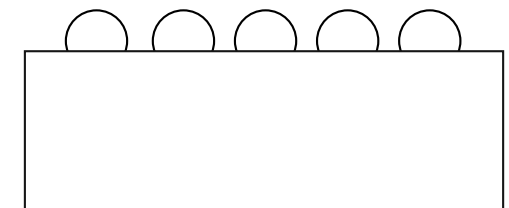

# 581 Lucillia | Pattern continuity plan

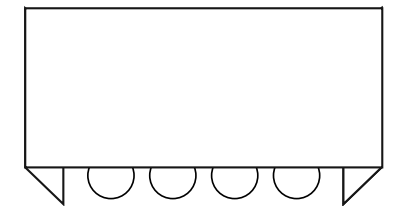
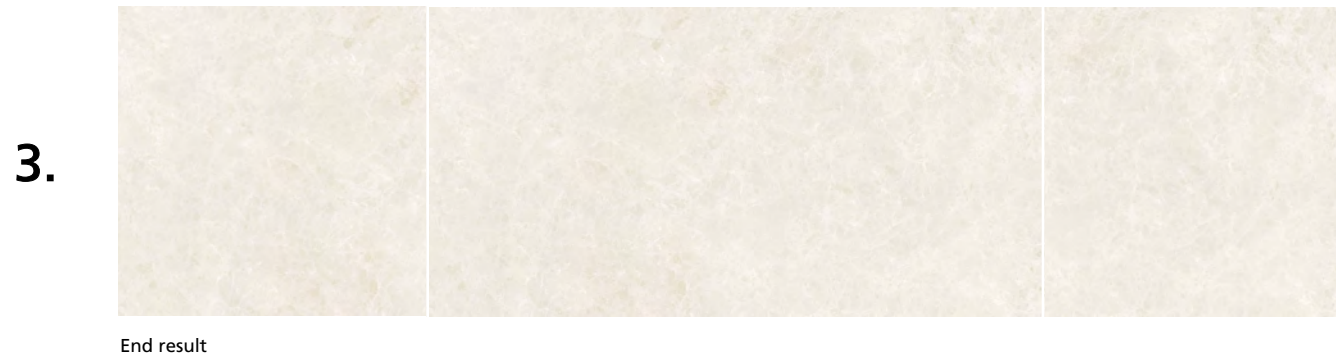
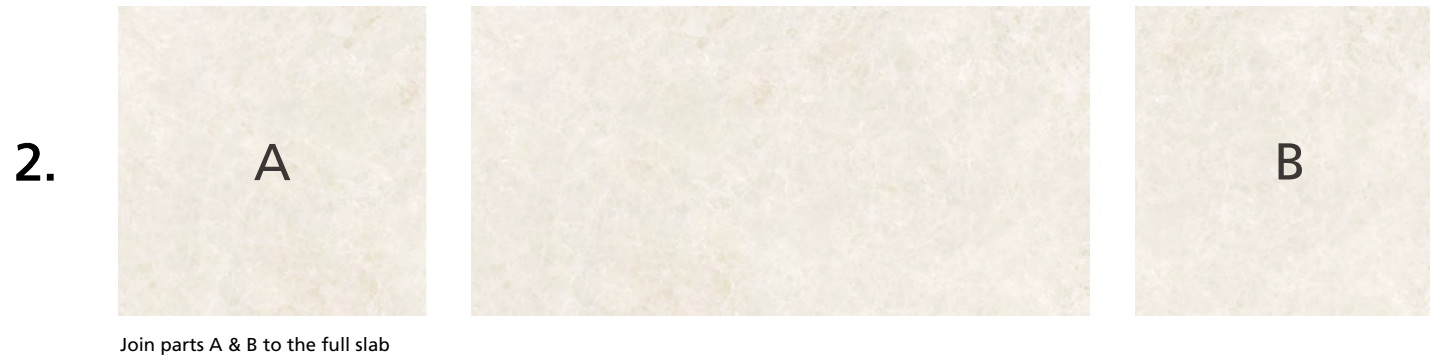
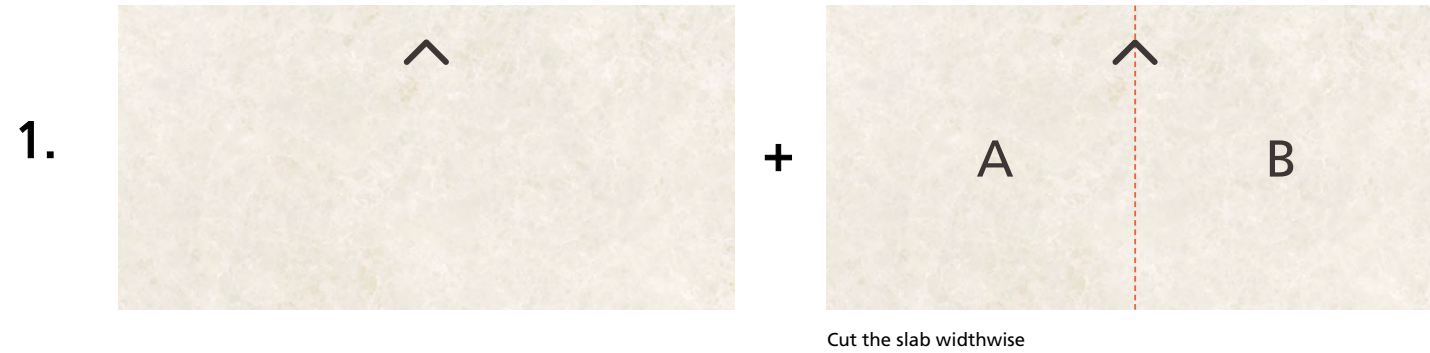

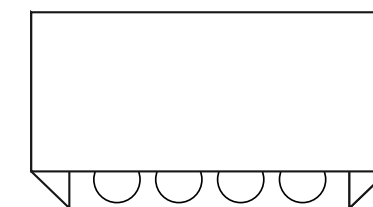
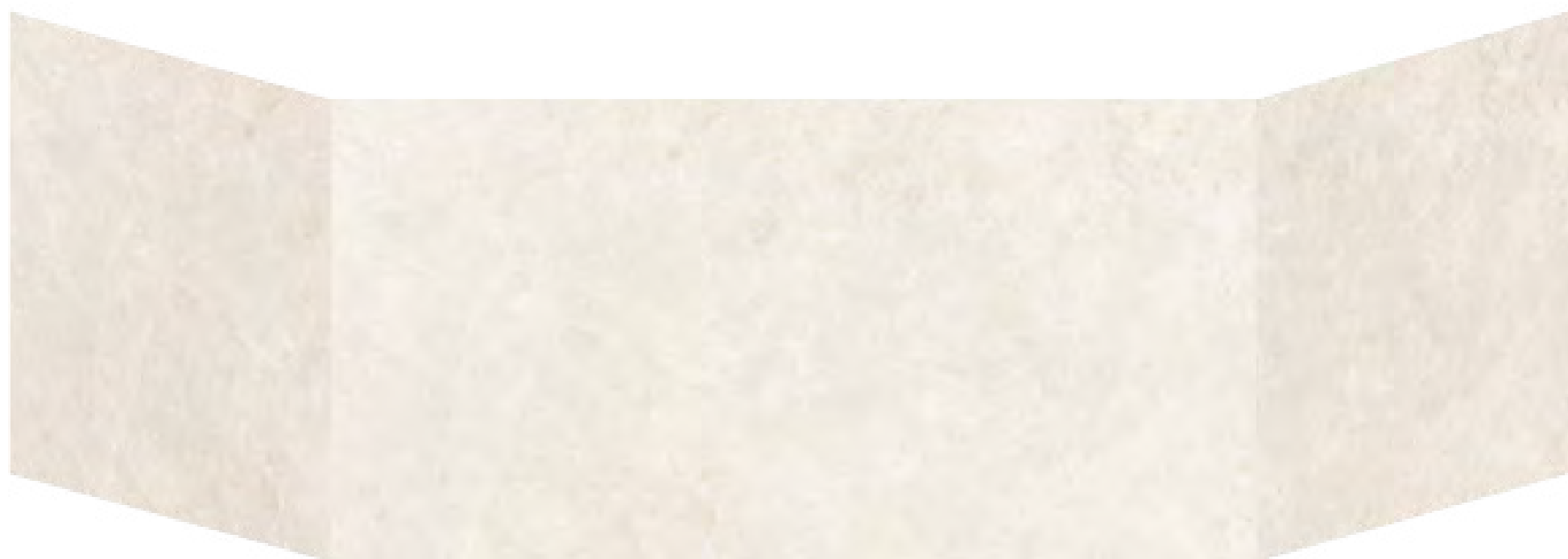

# 581 Lucillia | Pattern continuity plan

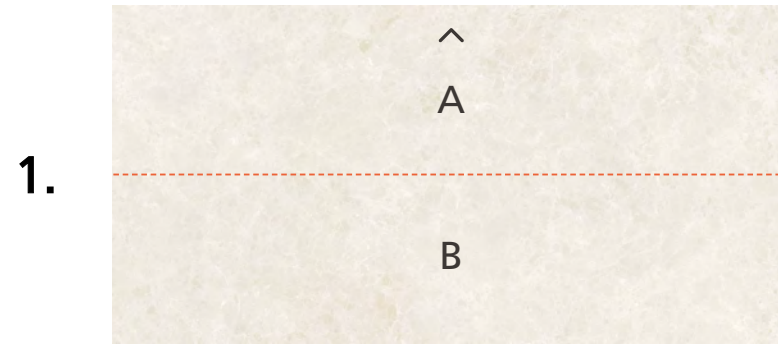

Cut the slab lengthwise

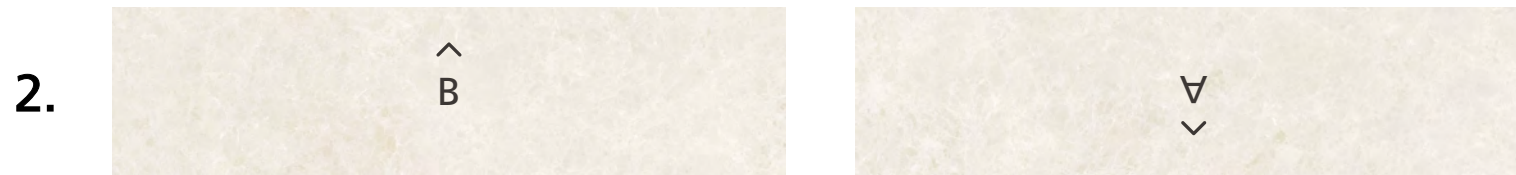

Rotate part A 180° and join parts A & B

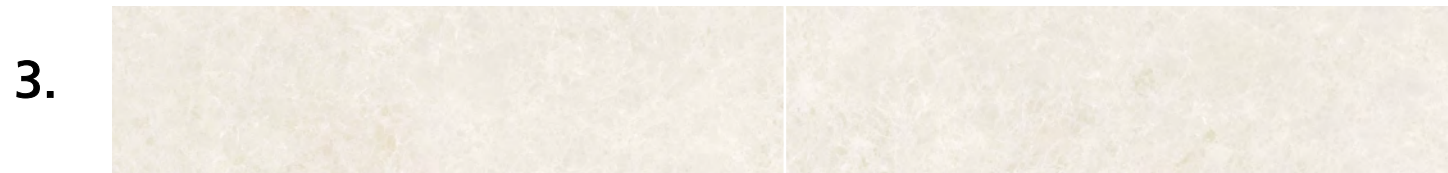

End result

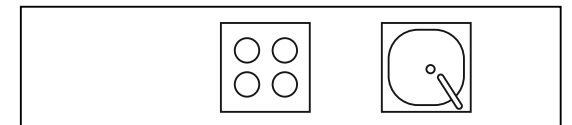

581 Lucillia | End result

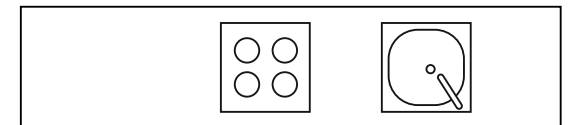
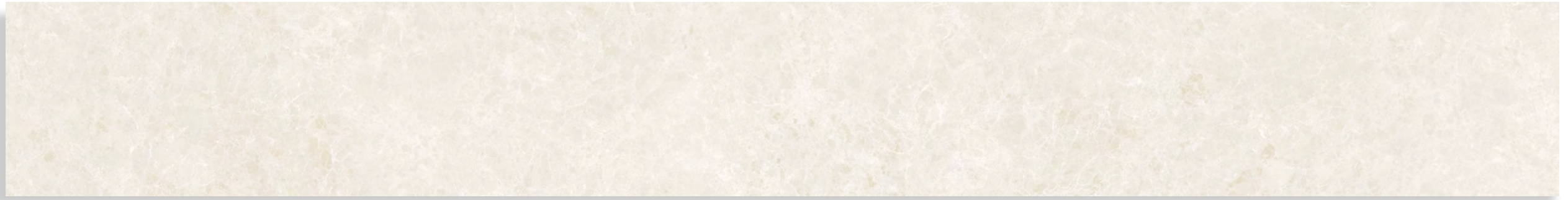

# 581 Lucillia | Pattern continuity L-shape

1.

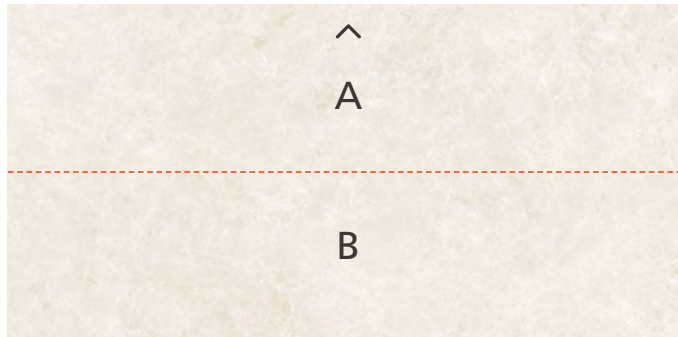

Cut the slab lengthwise

2.



Rotate part A 180°. Rotate part B (90° and join parts A & B.



3.

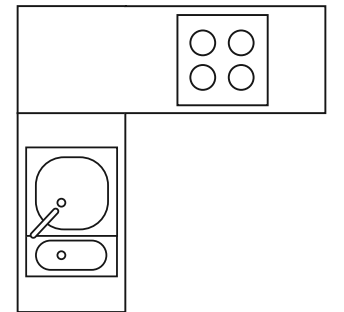
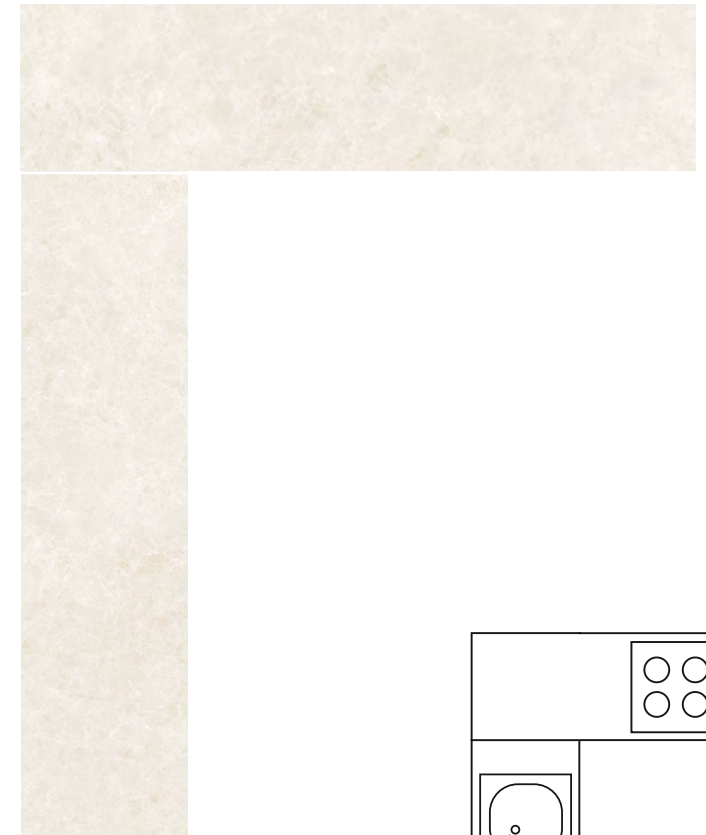

581 Lucillia | End result

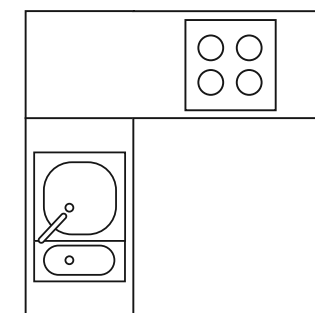
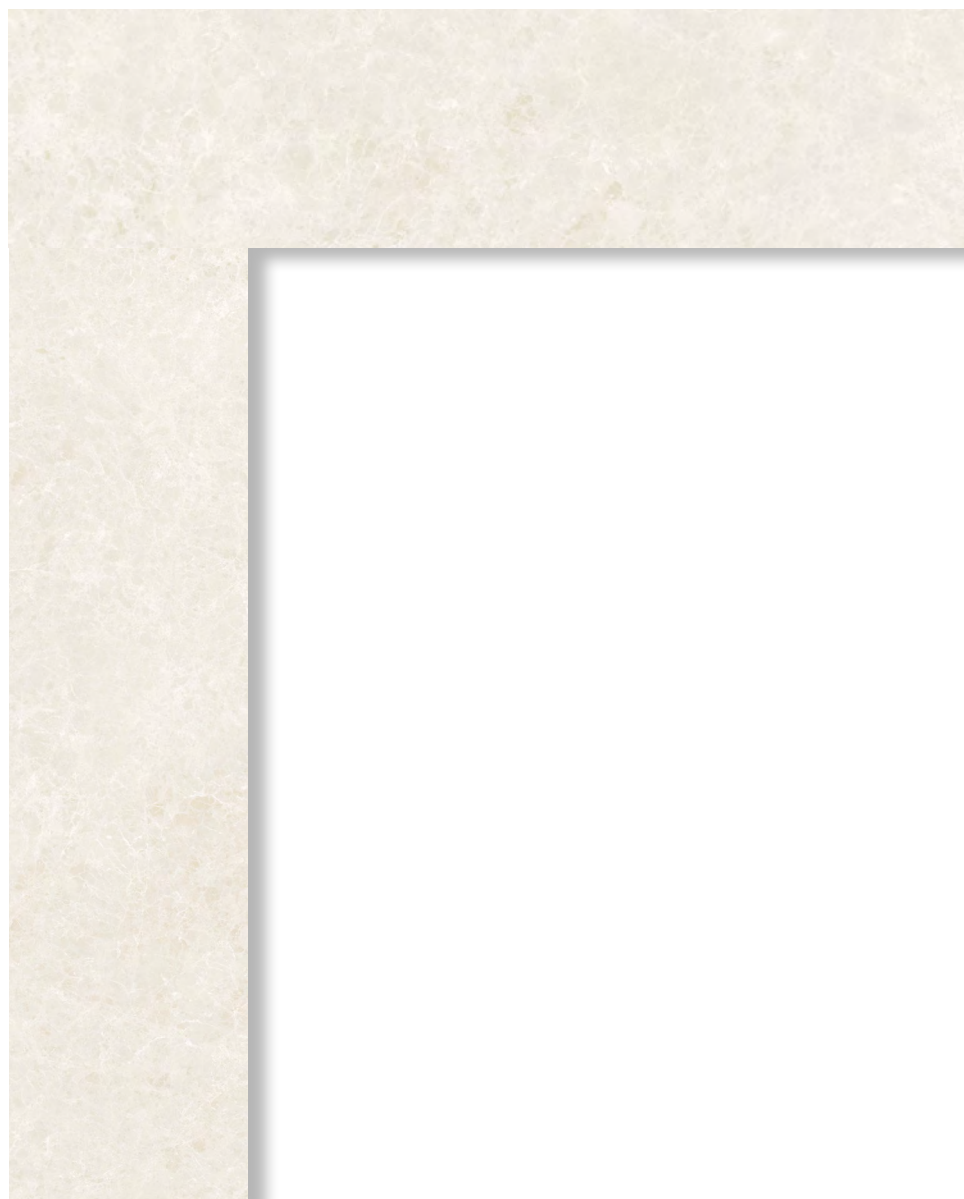

581 Lucillia | Pattern continuity countertop to backsplash

1.

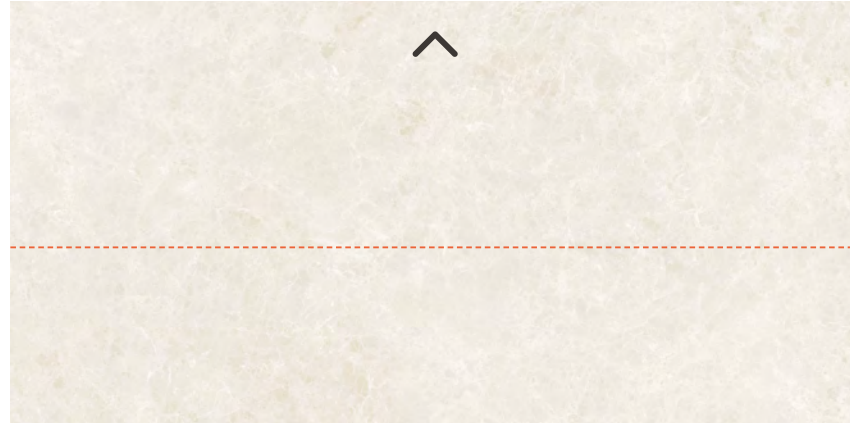

Cut the slab lengthwise

2.

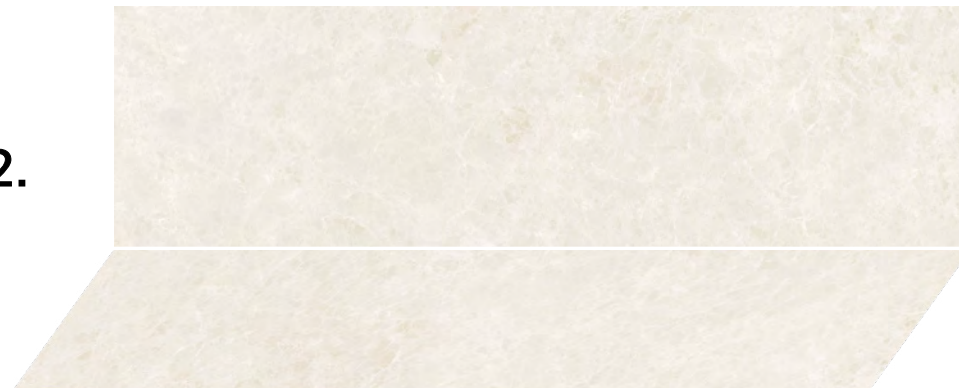

End result



# 581 Lucillia | End result

